

ENGLISH

User manual



TABLE OF CONTENTS

1. PRECAUTIONS AND SAFETY MEASURES	3
1.1. Preliminary instructions	3
1.2. During use	4
1.3. After use	4
1.4. Definition of measurement (overvoltage) category	4
2. GENERAL DESCRIPTION	5
2.1. Measuring average values and TRMS values	5
2.2. Definition of true root mean square value and crest factor	5
3. PREPARATION FOR USE	6
3.1. Initial checks	6
3.2. Instrument power supply	6
3.3. Storage	6
4. NOMENCLATURE	7
4.1. Instrument description	7
4.1.1. Alignment marks	7
4.1.2. Hand protection	8
4.1.3. Indication of the conventional direction of Current	8
4.2. Function keys description	9
4.2.1. F1, F2, F3, F4/OK keys	9
4.2.2. H/ESC/ key	9
4.3. Initial screen	9
4.4. Instrument settings	10
4.4.1. General menu	10
4.4.2. Date/Time menu	10
4.4.3. Log menu	11
4.4.4. Continuity menu	11
4.4.5. Memory REC – Deleting saved data	11
4.4.6. Memory IRC	12
5. OPERATIVE INSTRUCTIONS	13
5.1. AC Voltage detection	13
5.2. DC Voltage measurement	13
5.3. AC and AC+DC Voltage measurement	15
5.3.1. Voltage Harmonics measurement	17
5.3.2. Phase Sequence and Phase Conformity with 1 wire	18
5.4. DC Current measurement	23
5.5. AC and AC+DC Current measurement	25
5.5.1. Current Harmonics measurement	27
5.6. Dynamic Inrush current measurement	28
5.7. DC Power and Energy measurement	31
5.8. AC and AC+DC Power and Energy measurement	35
5.9. Resistance and Continuity test measurement	41
6. CONNECTION OF INSTRUMENT TO PC AND MOBILE DEVICES	43
6.1. Download saved data	43
6.2. Real-Time readings	46
6.3. Connection to mobile devices	48
7. MAINTENANCE	49
7.1. General information	49
7.2. Battery replacement	49
7.3. Cleaning the instrument	49
7.4. End of life	49
8. TECHNICAL SPECIFICATIONS	50
8.1. Technical characteristics	50
8.1.1. Reference guidelines	52
8.1.2. General characteristics	52
8.2. ENVIRONMENT	53
8.2.1. Environmental conditions for use	53

8.3.	Accessories	53
8.3.1.	Accessories provided.....	53
9.	SERVICE	54
9.1.	Warranty conditions.....	54
9.2.	Service	54
10.	APPENDIX – THEORETICAL OUTLINE	55
10.1.	Voltage and current harmonics	55

1. PRECAUTIONS AND SAFETY MEASURES

The instrument has been designed in compliance with directive IEC/EN61010-1 relative to electronic measuring instruments. For your safety and in order to avoid damaging the instrument, please carefully follow the procedures described in this manual and read all notes preceded by the symbol  paying the utmost attention.

Before and after carrying out measurements, carefully observe the following instructions:

- Do not carry out any voltage or current measurement in humid environments
- Do not carry out any measurement in case of gas, explosive and inflammable materials or dusty environments
- Avoid contact with the circuit under test if no measurement is carried out
- Avoid contact with exposed metal parts, with unused measuring probes, circuits, etc.
- Do not carry out any measurement in case of instrument's anomalies such as deformation, breaks, substance leaks, absence of displayed screen, etc.
- Pay special attention when measuring voltages higher than 20V, since a risk of electrical shock exists

The following symbols are used in this manual and on the instrument:



Warning: observe the instructions given in this manual; improper use could damage the instrument or its components.



High voltage danger: electrical shock hazard.



This symbol indicates that the clamp can operate on live conductors



Double-insulated meter



AC voltage or current



DC voltage or current



Connection to earth

1.1. PRELIMINARY INSTRUCTIONS

- This clamp has been designed for use in environments of pollution degree 2.
- It can be used for **CURRENT** and **VOLTAGE** measurements on installations with measurement category CAT IV 600V and CAT III 1000V. For a definition of measurement categories, see § 1.4.
- We recommend to follow the standard safety rules devised by the procedures for carrying out operations on live systems and using the prescribed PPE to protect the user against dangerous currents and the instrument against incorrect use.
- Only the leads supplied with the instrument guarantee compliance with the safety standards. They must be under good conditions and replaced with identical models, when necessary.
- Do not test circuits exceeding the specified current and voltage limits.
- Check that the battery is correctly inserted.
- Before connecting the test leads to the circuit under test, make sure that the switch is correctly set.
- Make sure that the LCD display and the switch indicate the same function.

1.2. DURING USE

Please carefully read the following recommendations and instructions:



CAUTION

Failure to comply with the Caution notes and/or Instructions may damage the instrument and/or its components or be a source of danger for the operator.

- Before activating the switch, remove the conductor from the clamp jaw or disconnect the test leads from the circuit under test.
- When the instrument is connected to the circuit, do not touch any unused terminal.
- Keep your hands always under the hand protection. This protection is always located in a suitable position to guarantee a correct safety distance from possible exposed or live parts (see Fig. 3)
- Avoid measuring resistance if external voltages are present. Even if the instrument is protected, excessive voltage could cause a malfunction of the clamp.
- During current measurement, any other current near the clamp may affect measurement accuracy.
- When measuring current, always put the conductor as close as possible to the middle of the clamp jaw, to obtain the most accurate reading.
- While measuring, if the value or the sign of the quantity under test remain unchanged, check if the HOLD function is enabled.

1.3. AFTER USE

- When measurement is complete, switch **OFF** the instrument.
- If the instrument is not to be used for a long time, remove the batteries

1.4. DEFINITION OF MEASUREMENT (OVERVOLTAGE) CATEGORY

Standard IEC/EN61010-1: "Safety requirements for electrical equipment for measurement, control and laboratory use, Part 1: General requirements" defines measurement category, commonly called overvoltage category. In § 6.7.4: Measured circuits, circuits are divided into the following measurement categories:

(OMISSIS)

- **Measurement category IV** is for measurements performed at the source of the low-voltage installation.

Examples are electricity meters and measurements on primary overcurrent protection devices and ripple control units.

- **Measurement category III** is for measurements performed on installations inside buildings.

Examples are measurements on distribution boards, circuit breakers, wiring, including cables, bus-bars, junction boxes, switches, socket-outlets in the fixed installation, and equipment for industrial use and some other equipment, for example, stationary motors with permanent connection to fixed installations.

- **Measurement category II** is for measurements performed on circuits directly connected to the low-voltage installation.

Examples are measurements on household appliances, portable tools and similar equipment.

- **Measurement category I** is for measurements performed on circuits not directly connected to MAINS.

Examples are measurements on circuits not derived from MAINS, and specially protected (internal) MAINS-derived circuits. In the latter case, transient stresses are variable; for that reason, the standard requires that the transient withstand capability of the equipment is made known to the user.

2. GENERAL DESCRIPTION

The instrument carries out the following measurements:

- DC voltage up to 1500V
- AC, AC+DC TRMS voltage up to 1000V
- “Voltsense” sensor for detection AC voltage without contact
- DC, AC, AC+DC TRMS current up to 1000A
- Resistance and continuity test
- Phase sequence and conformity test with 1 wire
- Measure/Recording AC Powers on single-phase and/or balanced three phase systems
- Measure/Recording power factor on single-phase and/or balanced three phase systems
- Measure/Recording AC energies on single-phase and/or balanced three-phase systems
- Measure/Recording DC power and energy
- Measure/Recording AC voltage harmonics up to 25° order and THD%
- Measure/Recording AC current harmonics up to 25° order and THD%
- Frequency voltage and current
- Electric motor starting currents (Dynamic Inrush)
- WiFi interface for PC and mobile device connection

Each of these functions can be selected using the selector switch. Keys **F1**, **F2**, **F3**, **F4/OK** and **H/ESC**/ are also provided. For their use, please refer to § 4.2.

2.1. MEASURING AVERAGE VALUES AND TRMS VALUES

Measuring instruments of alternating quantities are divided into two big families:

- AVERAGE-VALUE meters: instruments measuring the value of the single wave signals
- TRMS (True Root Mean Square) VALUE meters: instruments measuring the TRMS value of the quantity being tested

In the presence of a perfectly sinusoidal wave, both families of instruments provide identical results. In the presence of distorted waves, on the other hand, the readings shall differ. Average-value meters provide the RMS value of the sole fundamental wave, TRSM meters, instead, provide the RMS value of the whole wave, including harmonics (within the instrument's bandwidth)

2.2. DEFINITION OF TRUE ROOT MEAN SQUARE VALUE AND CREST FACTOR

The root mean square value of current is defined as follows: *"In a time equal to a period, an alternating current with a root mean square value of the intensity of 1A, circulating on a resistor, dissipates the same energy as that which would have been dissipated by a direct current with the intensity of 1 A during the same time "*. This definition results in the numeric expression:

$$G = \sqrt{\frac{1}{T} \int_{t_0}^{t_0+T} g^2(t) dt}$$

The *root mean square value* is indicated with the acronym RMS. The

Crest Factor is defined as the relationship between the Peak Value of a signal and its RMS

value: $CF (G) = \frac{G_p}{G_{RMS}}$ This value changes with the signal waveform, for a purely sinusoidal

wave it is $\sqrt{2} = 1.41$. In case of distortion, the Crest Factor takes higher values as wave distortion increases.

3. PREPARATION FOR USE

3.1. INITIAL CHECKS

Before shipping, the instrument has been checked from an electric as well as mechanical point of view. All possible precautions have been taken so that the instrument is delivered undamaged. However, we recommend generally checking the instrument in order to detect possible damage suffered during transport. In case anomalies are found, immediately contact the forwarding agent. We also recommend to check whether the package contains all components indicated in § 8.3. In case of discrepancy, please contact the Dealer. In case the instrument should be replaced, please carefully follow the instructions given in § 9.2.

3.2. INSTRUMENT POWER SUPPLY

The instrument is supplied by 2x1.5V LR03 AAA batteries. Replace them following the instructions in § 5.2.

3.3. STORAGE

In order to guarantee accurate measurements, after a long storage time under extreme environmental conditions, wait for the instrument to come back to normal condition (see § 8.2.1)

4. NOMENCLATURE

4.1. INSTRUMENT DESCRIPTION

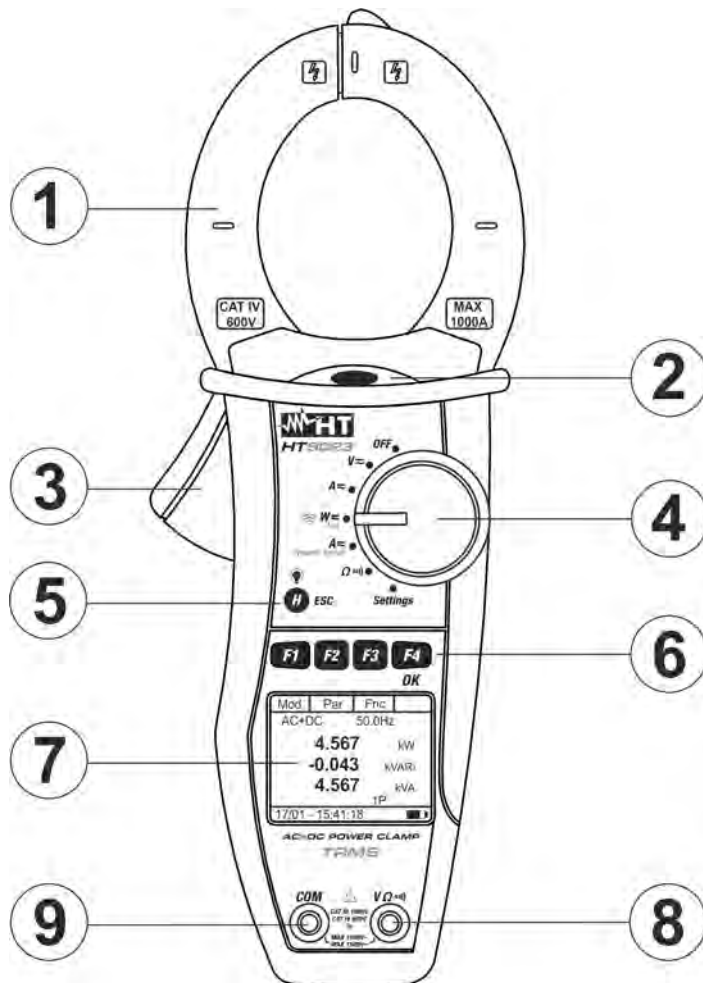

CAPTION:

1. Inductive clamp jaw
2. AC voltage indicator LED
3. Jaw trigger
4. Rotary selector switch
5. **H/ESC** key
6. **F1,F2,F3,F4/OK** function keys
7. LCD display
8. Input terminal **VΩ**
9. Input terminal **COM**

Fig. 1: Instrument description

4.1.1. Alignment marks

Put the conductor as close as possible to the middle of the jaws on the intersection of the indicated marks (see Fig. 2) in order to meet the meter accuracy specifications.

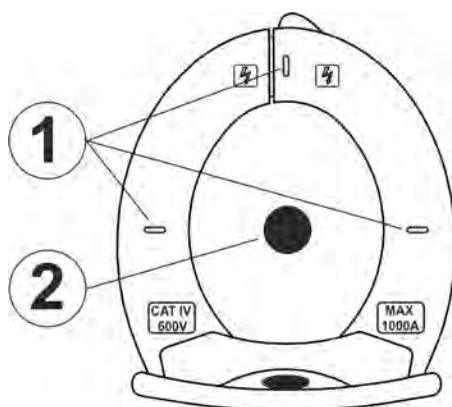

CAPTION:

1. Alignment marks
2. Conductor

Fig. 2: Alignment marks

4.1.2. Hand protection

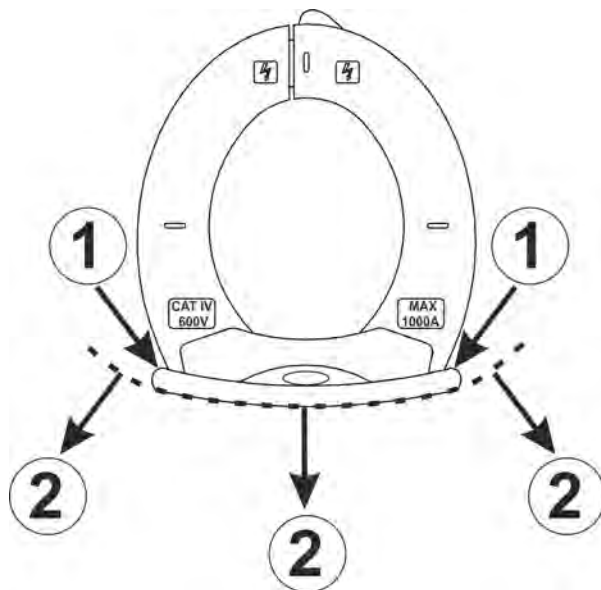

CAPTION:

1. Hand protection
2. Safe area

Fig. 3: hand protection

Always keep your hands under the hand protection. This protection is always located in a suitable position to guarantee a correct safety distance from possible exposed or live parts (see Fig. 3)

4.1.3. Indication of the conventional direction of Current

The Fig. 4 shows an arrow which indicates the conventional direction of current

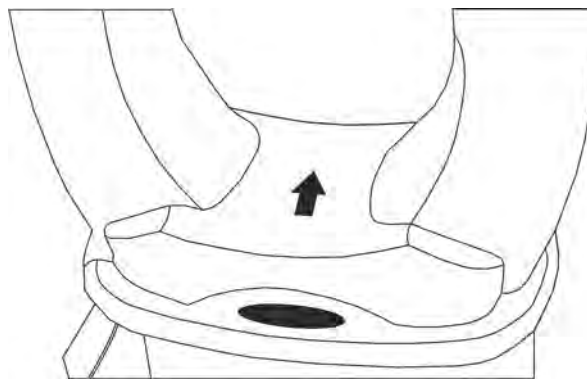

Fig. 4: Current direction arrow

4.2. FUNCTION KEYS DESCRIPTION

4.2.1. F1, F2, F3, F4/OK keys

The **F1**, **F2**, **F3**, **F4/OK** keys perform different functions according to the measurement set (for detailed information, see the single functions).

4.2.2. H/ESC/☹ key

A single press activates the Data HOLD function and the value of the measurement quantity is frozen at display. The symbol "H" is displayed when this function is enabled. This operating mode is disabled when "H" key is pressed again or the switch is operated. In order to improve the readability of the values measured in dark places, the display has been provided with a backlight function which is turned on and off by long-pressing "H" key. If the feature is set in MAN mode (see § 4.4) the backlight deactivates after approximately 30 seconds after its activation, in order to save battery life. The same key identify the **ESC** (Exit) functionality inside the different modes of the instrument.

4.3. INITIAL SCREEN

When switching on the instrument, the initial screen appears for a few seconds. It shows:

- The instrument's model
- The instrument's serial number
- The instrument's firmware version

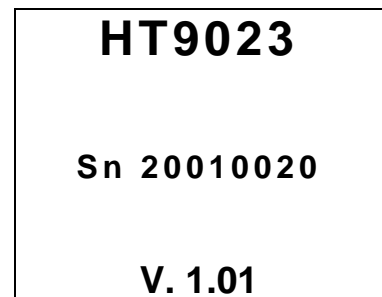

CAUTION

Please note down this information, especially the firmware version, in case it should be necessary to contact the service department.

After a few seconds, the instrument switches to the selected function.

4.4. INSTRUMENT SETTINGS

By positioning the selector switch to “Settings”, the screen aside will appear, containing the possible settings of the instrument.

Press **F2, F3** (▼,▲) keys to modify the settings of the selected items and **F4 (OK)** key to enter in the sub-menus and confirm the selections. Press **ESC** key to exit without save and return to previous screen.

	▼	▲	OK
General			
Date/Time			
Log			
Continuity			
Memory REC			
Memory IRC			
17/01 – 15:34:23			█

4.4.1. General menu

In this section is possible to manage the followed internal functions:

- **Language** → Press **F2, F3** (▼,▲) keys for the selection of the available languages and **F4 (OK)** key to confirm the selected item. The “Saved data” message is displayed for a while in the bottom part of display
- **Auto-off** → In this section it is possible to activate/deactivate the auto power off feature. Press **F2, F3** (◀, ▶) keys for the selection of the “ON” or “OFF” options and **F4 (OK)** key to confirm the selected item. The “Saved data” message is displayed for a while in the bottom part of display. The “” symbol is displayed with auto power off feature activated and the instrument switches off after approx. 5 minutes of idleness
- **Backlight.** → In this section it is possible to select the activation mode of display backlight. Press **F2, F3** (◀, ▶) keys for the selection of the “MAN” option (backlight manually activated by pressing “H” key and disable after approx. 30 seconds) or “ON” (backlight always active) and **F4 (OK)** key to confirm the selected item. The “Saved data” message is displayed for a while in the bottom part of display. The “ON” option can result a significant reduction of the battery life

Sel	▼	▲	OK
Language:			
English			
Auto-off:			
OFF			
Backlight:			
MAN			
17/01 – 15:34:23			█

4.4.2. Date/Time menu

By selecting the “Date/Time” item the instrument shows the screen aside will appear. Press **F1 (Sel)** key to move the cursor and press the **F2, F3** (▼, ▲) keys to modify the settings of the selected item. The “Format” item allows to select the date/time format between **EU (European)** or **USA (American)**. Press **F4 (OK)** key to confirm the selected item. The “Saved data” message is displayed for a while in the bottom part of display

Sel	▼	▲	OK
Year: 20			
Month: 01			
Day: 17			
Hour: 15			
Minute: 34			
Format: EU			
17/01 – 15:34:23			█

4.4.3. Log menu

By selecting the “**Log**” item the instrument shows the screen aside will appear. Press the **F2, F3** (▼, ▲) keys to modify the settings of the **Integration Period** parameter (aggregation time between two consecutive saving inside a recording operation). The followed values are available: **1s, 5s, 10s, 30s, 60s, 120s, 300s, 600s** or **900s**. Press **F4 (OK)** key to confirm the selected item. The “Saved data” message is displayed for a while in the bottom part of display

	▼	▲	OK
Int. Period:			
005 s			
17/01 – 15:34:23			

4.4.4. Continuity menu

By selecting the “**Continuity**” item the instrument shows the screen aside will appear. Press the **F2, F3** (▼, ▲) keys to modify the setting of the limit threshold value below which the instrument emits a sound in the continuity tests (see § 5.9). The value is selectable in the field: **1Ω ÷ 150Ω in steps of 1Ω**. Press **F4 (OK)** key to confirm the selected item. The “Saved data” message is displayed for a while in the bottom part of display

	▼	▲	OK
Res Lim..			
002 Ω			
17/01 – 15:34:23			

4.4.5. Memory REC – Deleting saved data

In the “**Memory REC**” section there is a list of all the recordings saved in the instrument. The screen on the side is shown on the display. The meaning of the items are the follows:

- **Sxx** → Indicates the saving of an instant sampling (Snapshot) performed by the instrument (see § 6.2) together with the date/time in which it was saved. The number “xx” indicates the memory location used
- **Lxx** → indicates the saving of a recording (Logger) performed by the instrument (see § 5.7 and § 5.8) together with the date/time when it was started. The number “xx” indicates the memory location where the data is saved
- **Auton** → indicates the remaining residual memory available for saving snapshots/recordings expressed in days/hours

	Del	Esc	OK
S01:15/01-16.56:42			
L02:17/01-16:59:00			
L03:17/01-17:10:00			
Auton: 00d/10h			
17/01 – 18:34:23			

The visualization of the recorded data is possible only through the TopView management software or the HTAnalysis APP

Press the **F3 (ESC)** key to exit and return to the general menu. Press **F4 (OK)** to confirm the operations

Press the **F2 (Del)** key to clear the data saved in the memory. The following screen is shown on the display. Use the **F2** key to section the items:

- **Del. Tot.** → Delete all contents of the memory
- **Del. Last** → Delete the last saved data

Press **F4 (OK)** to confirm the operations

	Del	Esc	OK
S01:1			
L02:1			
L03:17/01-17:10:00			
Auton: 00d/10h			
17/01 – 18:34:23			

4.4.6. Memory IRC

In the "Memory IRC" section there is a list of all the inrush current measurements saved by the instrument (see § 5.6). The screen like the one on the side is shown on the display. The meaning of the item is the follows:

- **lxx** → indicates the saving of the inrush current measurement together with the date/time in which it was saved. The number "xx" indicates the memory location used

	Del	Esc	OK
I01:13/12-10:41:20			
I02:13/12-10:44:21			
I03:13/12-10:45:01			
I04:13/12-10:45:58			
17/01 – 18:34:23			

The visualization of the recorded data is possible only through the TopView management software or the HTAnalysis APP

Press the **F3 (ESC)** key to exit and return to the general menu.
Press **F4 (OK)** to confirm the operations.

Press the **F2 (Del)** key to clear the data in the memory. The followed screen is shown on the display. Use the **F2** key to section the below items:

- **Del. Tot.** → Delete all contents of the memory
- **Del. Last** → Delete the last saved data

	Del	Esc	OK
I01:1	Del.Tot.		0
I02:1	Del.Last		1
I03:13/12-10:45:01			
I04:13/12-10:45:58			
17/01 – 18:34:23			

Press **F4 (OK)** to confirm the operation

The visualization of the recorded data is possible only through the TopView management software or the HTAnalysis APP

5. OPERATIVE INSTRUCTIONS

5.1. AC VOLTAGE DETECTION

With the selector switch set to “V \approx ” by taking the end of the clamp jaw near an AC source, the red LED at the base of the clamp jaw will turn on (see Fig. 1 – part 2), which indicates that voltage is present.



CAUTION

Phase detection is active only when the clamp selector switch is set to “V \approx ” position

5.2. DC VOLTAGE MEASUREMENT



CAUTION

- The maximum DC input voltage is 1500V. When the display shows “> 1500.0V”, it means that the maximum value that clamp is capable of measuring has been exceeded. Exceeding these limits could result in electrical shocks to the user and damage to the instrument.
- The CAT III 1000V marking on test leads guarantees the safe measurement of voltage up to 1500V

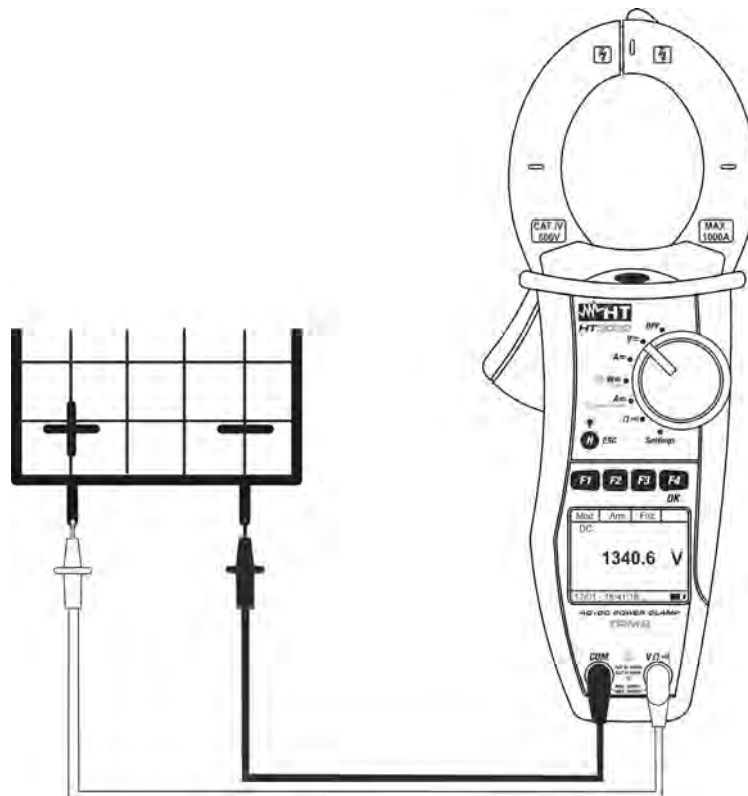

Fig. 5: DC Voltage measurement

1. By positioning the selector switch to “V \approx ”, the screen aside will appear

Mod	Har	Fnc	
	AC	< 42.5	Hz
		0.0	V
17/01 – 18:34:23			

2. Press **F1 (Mod)** key to open the drop-down menu shown on the screen nearby and select the “**DC**” option with the same key
3. Press the **F4 (OK)** to confirm. The instrument goes into DC voltage measurement mode. The **F2 (Har)** key is not active in this function

Mod	Har	Fnc	OK
AC		< 42.5 Hz	
DC			
AC+DC			
Ph Seq	0		V
Help			
17/01 – 18:34:23			

4. Connect red cable to input lead **VΩ⁾⁾⁾** and black cable to input lead **COM** then position the leads at the desired points of the circuit under test (see Fig. 5)
5. The screen shows an example of DC Voltage measurement.

Mod	Har	Fnc	
			DC
			9.1 V
17/01 – 18:34:23			

6. Press **F3 (Fnc)** key to open the drop-down menu shown on the screen nearby. At each subsequent pressure of **F3** key, the cursor will scroll through the available items, as follows:

- **Max**: it constantly displays the maximum value of the measured DC Voltage
- **Min**: it constantly displays the minimum value of the measured DC Voltage
- **Cr+**: it constantly displays the maximum positive crest value
- **Cr-**: it constantly displays the minimum negative crest value
- **RST**: (RESET) it deletes all stored Max, Min, Cr+ and Cr- values and re-start with a new measure
- **ESC**: it goes back from **Max/Min/Cr+/Cr-** and return to normal measuring mode

Mod		Fnc	OK
	DC	Max	
		Min	
		Cr+	
		Cr-	
		RST	V
		Esc	
17/01 – 18:34:23			

7. By pressing **F4 (OK)**, the selected item is confirmed. Nearby an example of measurement with active Max function. The “Max” symbol indicates the active function

Mod	Arm	Fnc	
Max			DC
			12.0 V
17/01 – 18:34:23			



CAUTION

The measurement of the 4 Max, Min, Cr+ and Cr- values is simultaneous, regardless of the displayed value.

8. For the use of HOLD and backlight feature see § 4.4

5.3. AC AND AC+DC VOLTAGE MEASUREMENT



CAUTION

The maximum AC and AC+DC input voltage is 1000V. When the display shows “> 999.9V”, it means that the maximum value which clamp is capable of measuring has been exceeded. Exceeding these limits could result in electrical shocks to the user and damage to the instrument.

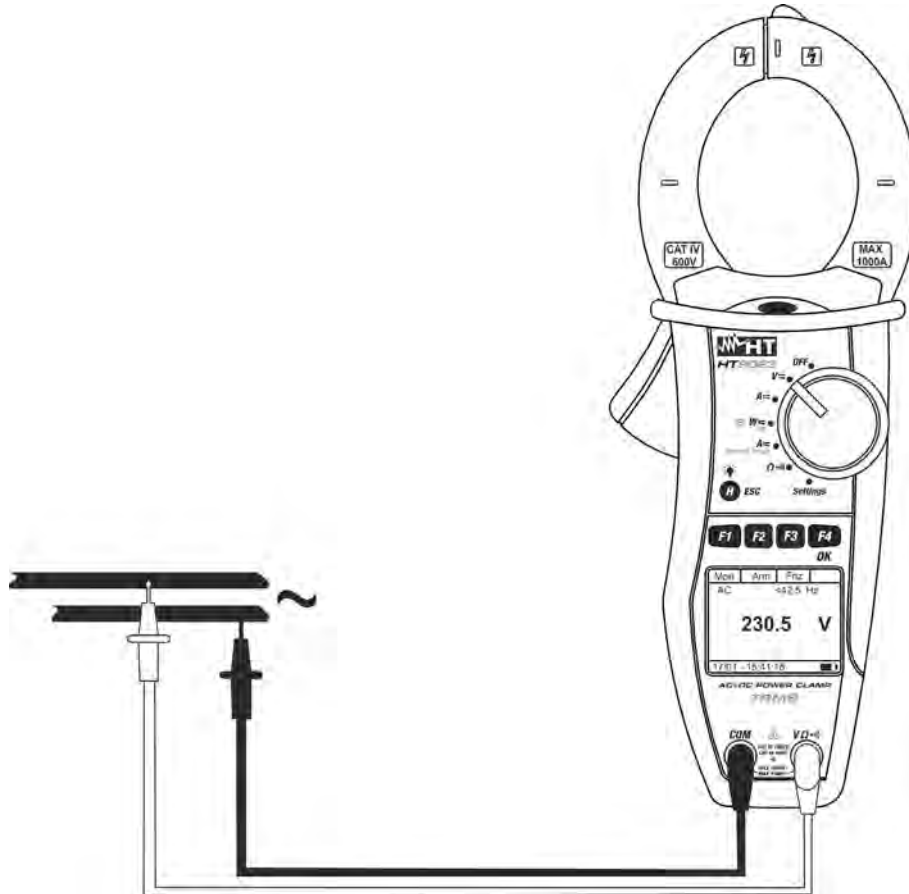

Fig. 6: AC and AC + DC voltage measurement

1. By positioning the selector switch to “V_~”, the screen nearby will appear

Mod	Har	Fnc	
	AC	< 42.5	Hz
		0.0	V
17/01 – 18:34:23 █			

2. Press **F1 (Mod)** to open the drop-down menu shown on the screen aside and select the “AC” or “AC+DC” option with the same key
3. Press **F4 (OK)** to confirm

Mod	Har	Fnc	OK
AC		< 42.5	Hz
DC			
AC+DC		0	V
Ph Seq			
Help			
17/01 – 18:34:23 █			

4. Connect red cable to input lead **VΩ⁾⁾⁾** and black cable to input lead **COM** then position the leads to the desired points of the circuit under test (see Fig. 6)

5. The screen shows an example of AC voltage measurement. The instrument allows the evaluation of possible DC components overlapped on a generic alternate waveform (AC+DC) signal and this can be very useful for the measurements on impulsive signals typically of no-linear loads (e.g: welders, electric ovens, etc)

Mod	Har	Fnc	
	AC	50.0	Hz
230.1			V
17/01 – 18:34:23			

6. Press **F3 (Fnc)** to open the drop-down menu shown on the screen aside. At each subsequent pressure of key **F3**, the cursor will scroll through the available items, as follows:

- **Max**: it constantly displays the maximum value of the measured AC+DC Voltage
- **Min**: it constantly displays the minimum value of the measured AC+DC Voltage
- **Cr+**: it constantly displays the maximum positive crest value
- **Cr-**: it constantly displays the minimum negative crest value
- **RST**: (RESET) it deletes all stored Max, Min, Cr+ and Cr- values and re-start with a new measure
- **Esc**: it goes back from **Max/Min/Cr+/Cr-** and return to normal measuring mode

Mod	Har	Fnc	OK
	AC	Max	
		Min	
		Cr+	
		Cr-	
	2	RST	V
		Esc	
17/01 – 18:34:23			



CAUTION

Note: the measurement of the 4 Max, Min, Cr+ and Cr- values is simultaneous, regardless of the displayed value.

7. By pressing **F4 (OK)**, the selected item is confirmed. Nearby, an example of measurement with active Max function.

Mod	Har	Fnc	
AC	50.0	Hz	
Max			
231.5			V
17/01 – 18:34:23			

8. For the use of HOLD and backlight features see § 4.4

5.3.1. Voltage Harmonics measurement

1. Press **F2 (Har)** key to select the screen of voltage harmonics as shown nearby. Press again **F2 (RMS)** to go back to voltage measurement screen

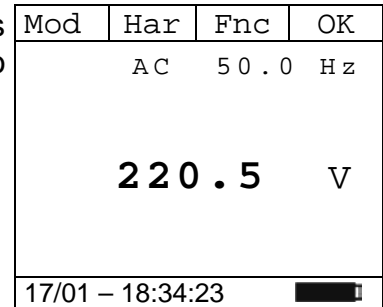

2. By pressing **F1 (◀)** or **F4 (▶)**, it is possible to move the cursor over the graph and select the harmonic to be measured. The correspondent absolute or percentage value of harmonic voltage is shown. It is possible to measure up to the 25th harmonic

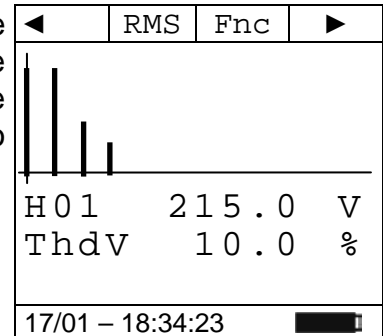

3. While measuring Voltage Harmonics, press **F3 (Fnc)** to open the drop-down menu shown on the screen aside. At each subsequent pressure of **F3**, the cursor will scroll through the available items, as follows:

- **Max**: it constantly displays the maximum RMS value of the selected current harmonic
- **Min**: it constantly displays the minimum RMS value of the selected current harmonic
- **Abs**: it displays the absolute value of the harmonics in Volts
- **%**: it displays the value of the harmonics as percentage value with respect to the fundamental
- **RST (RESET)** it deletes all stored Max, Min values and re-start with a new measure
- **Esc**: it goes back to a normal measuring mode

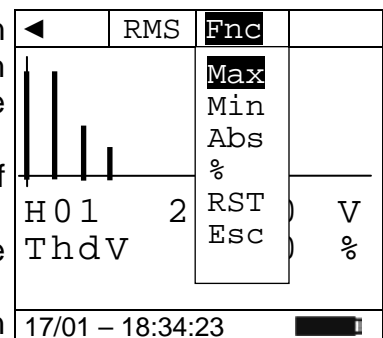

CAUTION

Since the menu contains functions with a different meaning (Max-Min and Abs-%), it is necessary to enter the menu twice: first for displaying Abs or % values and second time to enable the Max or Min functions

4. By pressing **F4 (OK)**, the selected item is confirmed. Nearby, an example of measurement with active Max function. The display shows the active function.

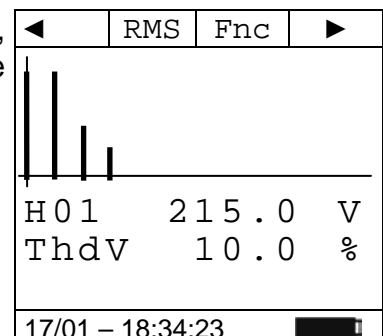

5. For the use of HOLD and backlight features see § 4.4

5.3.2. Phase Sequence and Phase Conformity with 1 wire



CAUTION

While measuring, the instrument must be held in the operator's hand.

Phase sequence test

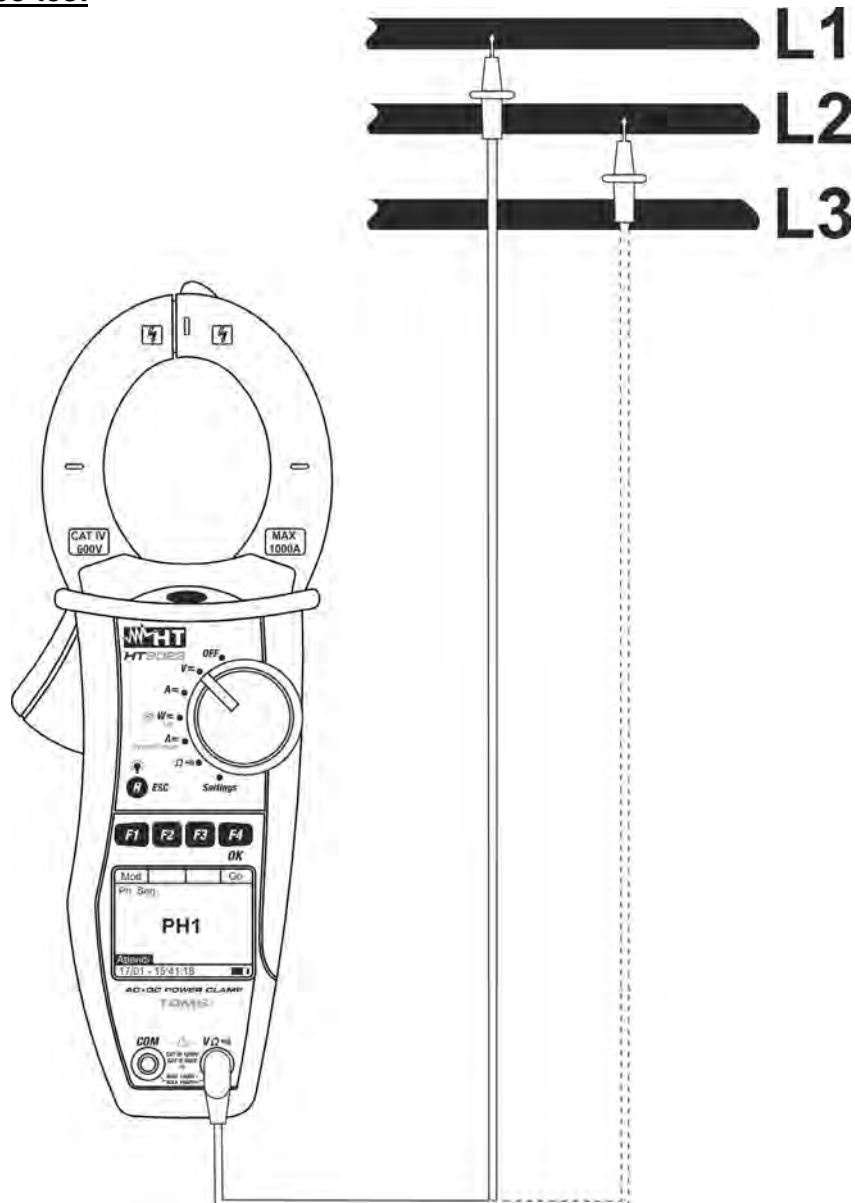

Fig. 7: Verification of phase sequence

1. Press **F1 (Mod)** to open the drop-down menu shown on the screen nearby and select the “**Ph Seq**” option with the same key
2. Press **F4 (OK)** to confirm. The followed screen is shown on the display

Mod	Har	Fnc	OK
AC		< 42.5	Hz
DC			
AC+DC			
Ph Seq	0		V
Help			
17/01 - 18:34:23			

3. The instrument shows the “PH1” message and waits for the detection of L1 phase
4. Connect red cable to input lead **VΩ**) and black cable to input lead **COM** then position the leads respectively to the L1 phase and the ground reference PE of the circuit under test (see Fig. 7).

Mod			Go
Ph Seq			
PH1			
Wait			
17/01 – 18:34:23			

CAUTION



If the frequency of the measured voltage is lower than 42.5Hz or higher than 69Hz, the display shows the message “**F<42.5 Hz**” or “**F>69 Hz**” and phase detection does not start.

5. When a **voltage $\geq 100V$** is detected, the instrument emits a sound signal (buzzer) and the message “**Meas**” is displayed. Do not press any key and keep the test lead connected to L1 phase cable.

Mod			Go
Ph Seq			
PH1			
Meas			
17/01 – 18:34:23			

6. Once phase L1 acquisition is complete, the instrument stops the acoustic signal and the “**Discon.**” Message is shown. Disconnect the test lead from phase L1 cable.

Mod			Go
Ph Seq			
Discon.			
Wait			
17/01 – 18:34:23			

7. The message “**PH2**” is shown and the instrument waits for the detection of L2 phase. Connect the test lead to phase L2 cable (see Fig. 7)

Mod			Go
Ph Seq			
PH2			
Wait			
17/01 – 18:34:23			

CAUTION



If more than 3 seconds elapse before detecting phase L2, the instrument displays the message “**Time Out**”. It is necessary to repeat the measuring cycle from the beginning, by pressing **F3 (New)** and starting again from point 3.

8. When a **voltage $\geq 100V$** is detected, the instrument emits a

Mod			Go
-----	--	--	----

sound signal (buzzer) and the message “**Meas**” is displayed. Do not press any key and keep the test lead connected to L2 phase cable

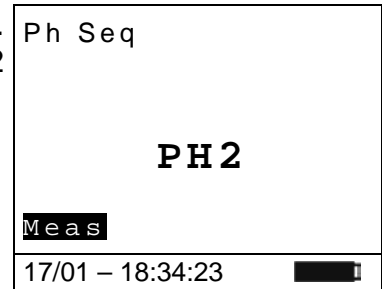

9. If the two phases, to which the test lead has been connected, are in the correct sequence, the message “**123**” is displayed. If the phase sequence is incorrect, the message “**132**” is displayed

10. To start a new measurement, press **F4 (Go)**

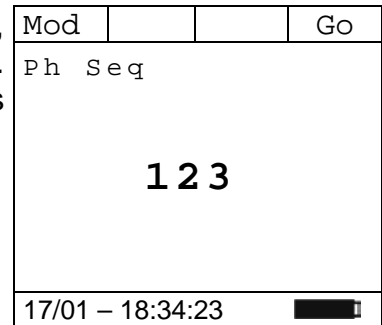

Phase conformity test

CAUTION

While measuring, the instrument must be held in the operator's hand.

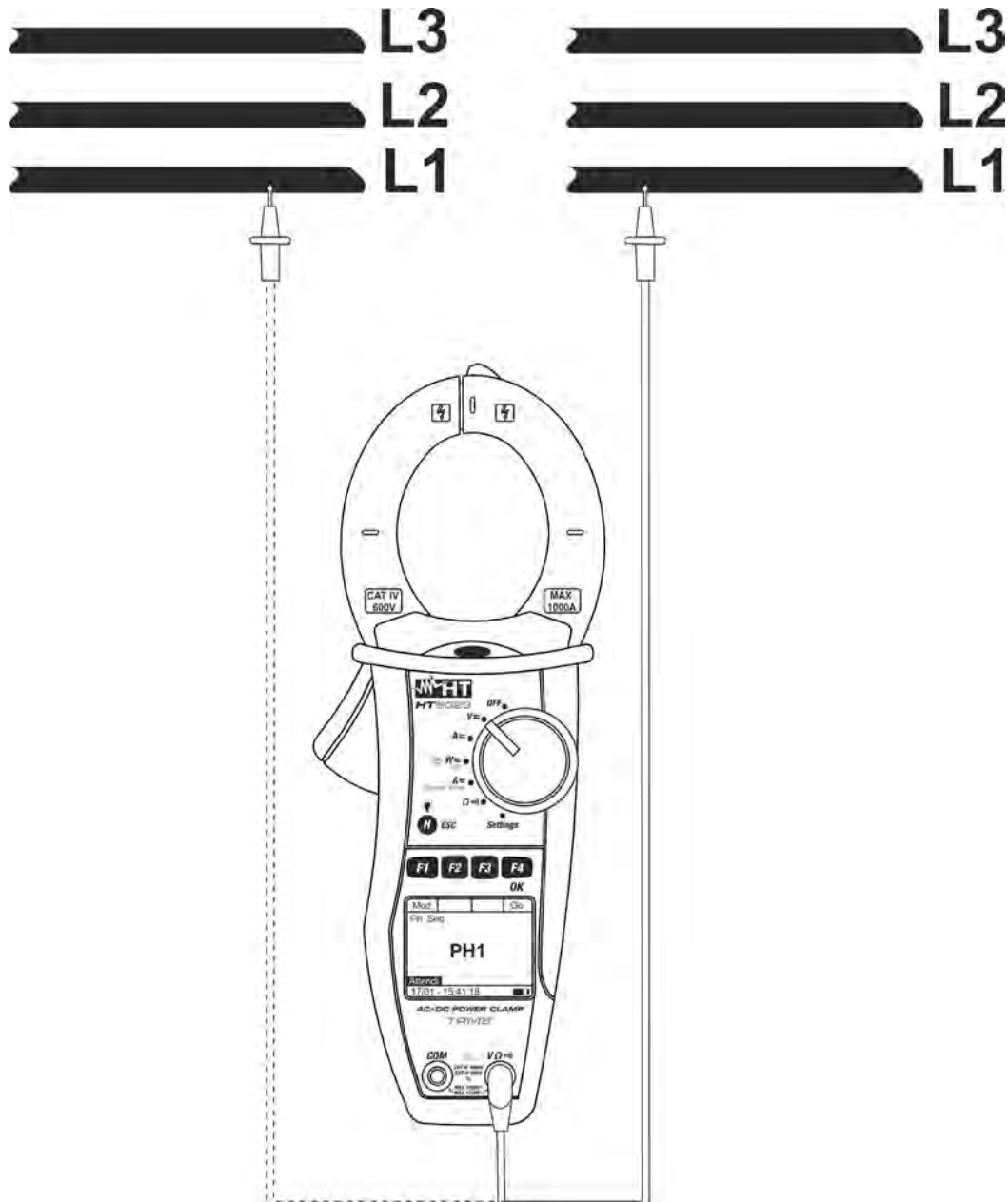

Fig. 8: Verification of phase conformity

1. The instrument shows the screen nearby, and waits for the detection of L1 phase of the first system
2. Connect the red cable to the input lead $V\Omega$ then position the lead **on the L1 phase of the first system** of the circuit under test (see Fig. 8)

Mod			Go
Ph Seq			
PH1			
Wait			
17/01 - 18:34:23			

3. When a **voltage $\geq 100V$** is detected, the instrument emits a sound signal (buzzer) and the message “**Meas**” is displayed. Do not press any key and keep the test lead connected to L1 phase cable of the first system

Mod			Go
Ph Seq			
PH1			
Meas			
17/01 – 18:34:23 ▬			

4. Once the voltage of L1 phase acquisition is complete, the instrument stops the sound signal and the “**Discon.**” Message is displayed. Disconnect the test lead from L1 phase of the first system.

Mod			Go
Ph Seq			
Discon.			
Wait			
17/01 – 18:34:23 ▬			

5. The message “**PH2**” is displayed and the instrument waits for the detection of L1 phase of the second system. Connect the test lead to L1 phase of the second system (see Fig. 8)

Mod			Go
Ph Seq			
PH2			
Wait			
17/01 – 18:34:23 ▬			

CAUTION



If more than 3 seconds elapse before detecting the phase L1 of the second sequence, the instrument displays the message “**Time Out**”. It is necessary to repeat the measuring cycle from the beginning, by pressing **F3 (New)** key and starting again from step 1.

6. When a **voltage $\geq 100V$** is detected, the instrument emits a sound signal (buzzer) and the message “**Meas**” is displayed. Do not press any key and keep the test lead connected to L1 phase cable of the second system

Mod			Go
Ph Seq			
PH2			
Meas			
17/01 – 18:34:23 ▬			

7. If there is correct conformity between the two phases, to which the test lead has been connected, the message “**11-**” is displayed. If not, the messages “**123**” or “**132**” are displayed.

To start a new measurement, press **F4 (Go)**.

Mod			Go
Ph Seq			
11 -			
17/01 – 18:34:23 ▬			

5.4. DC CURRENT MEASUREMENT

CAUTION



- The maximum measurable DC current is 1000A. When the display shows “> 999.9A”, it means that the maximum value that the clamp is capable of measuring has been exceeded. Exceeding these limits could result in electrical shocks to the user and damage to the instrument
- We recommend holding the clamp respecting the safety area created by the hand protection (see Fig. 3)

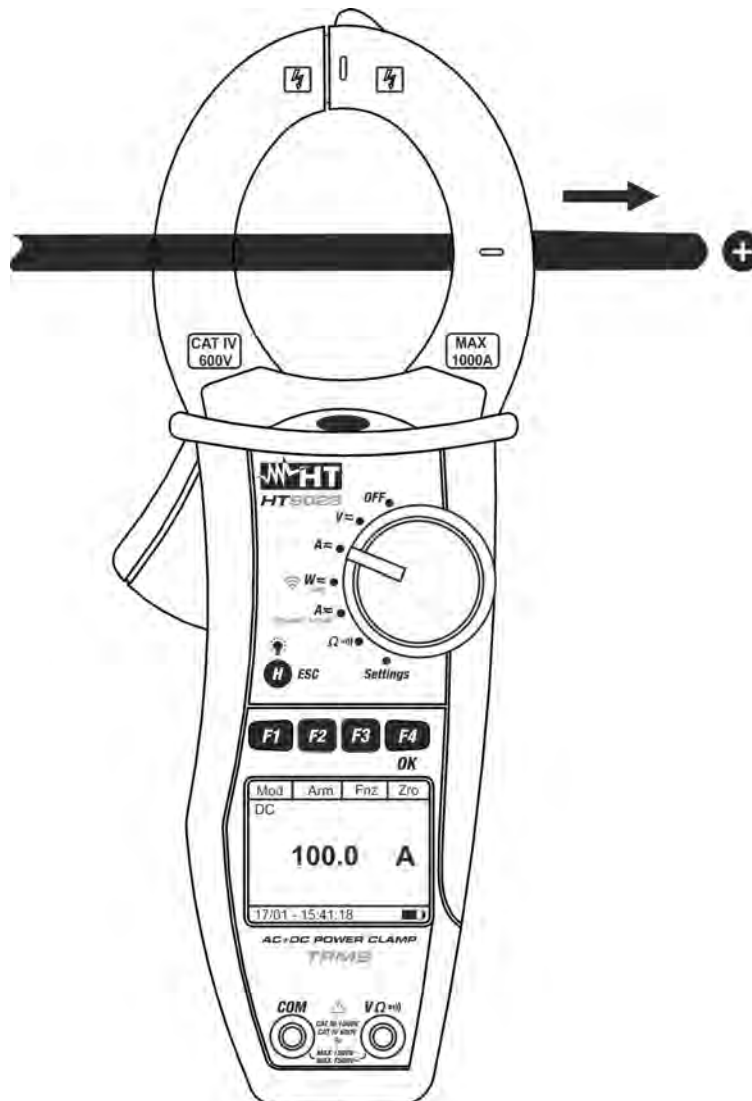

Fig. 9: DC current measurement

1. After positioning the selector switch to “**A=**”, the screen nearby will appear.

Mod	Har	Fnc	Zro
	AC	< 42.5	Hz
		0.0	A
17/01 - 18:34:23			

2. Press **F1 (Mod)** to open the drop-down menu shown on the screen aside and select the “**DC**” option with the same key. The **F2 (Har)** key is not active in this function
3. Press **F4 (OK)** to confirm. The instrument goes into DC current measurement mode
4. Press **F4 (Zro)** to perform the zero of value at display in order to delete the residual magnetization

Mod	Har	Fnc	OK
AC		< 42.5 Hz	
DC			
AC+DC			
Help			
0.0 A			
17/01 – 18:34:23			

5. Connect the cable to the middle of the clamp jaws, in order to get accurate measurements (see Fig. 9). Use the marks as a reference (see Fig. 2)

6. The screen shows an example of DC current measurement.

Mod	Har	Fnc	Zro
DC			
100.0			A
17/01 – 18:34:23			

7. Press **F3 (Fnc)** to open the drop-down menu shown on the screen aside. At each subsequent pressure of key **F3**, the cursor will scroll through the available items, as follows:

- **Max**: it constantly displays the maximum value of DC current
- **Min**: it constantly displays the minimum selected value of DC current
- **RST**: (RESET) it deletes all stored Max, Min, Cr+ and Cr- values and re-start with a new measure
- **Esc**: it goes back to a normal measuring mode

Mod		Fnc	OK
	DC	Max	
		Min	
		RST	
		Esc	
100			A
17/01 – 18:34:23			



CAUTION

- Always carry out current zeroing before clamping the cable
- The measurement of the 4 Max, Min, Cr+ and Cr- values is simultaneous, regardless of the one displayed.

8. Pressing **F4 (OK)**, the selected item is confirmed. Nearby, an example of measurement with active Max function. The display shows the active function.

Mod	Har	Fnc	Zro
DC		Max	
120.0			A
17/01 – 18:34:23			

9. For the use of HOLD and backlight features see § 4.4

5.5. AC AND AC+DC CURRENT MEASUREMENT

CAUTION



- The maximum measurable AC/AC+DC current is 1000A. When the display shows “> 999.9A”, it means that the maximum value that the clamp is capable of measuring has been exceeded. Exceeding these limits could result in electrical shocks to the user and damage to the instrument
- We recommend holding the clamp respecting the safety area created by the hand protection (see Fig. 3)

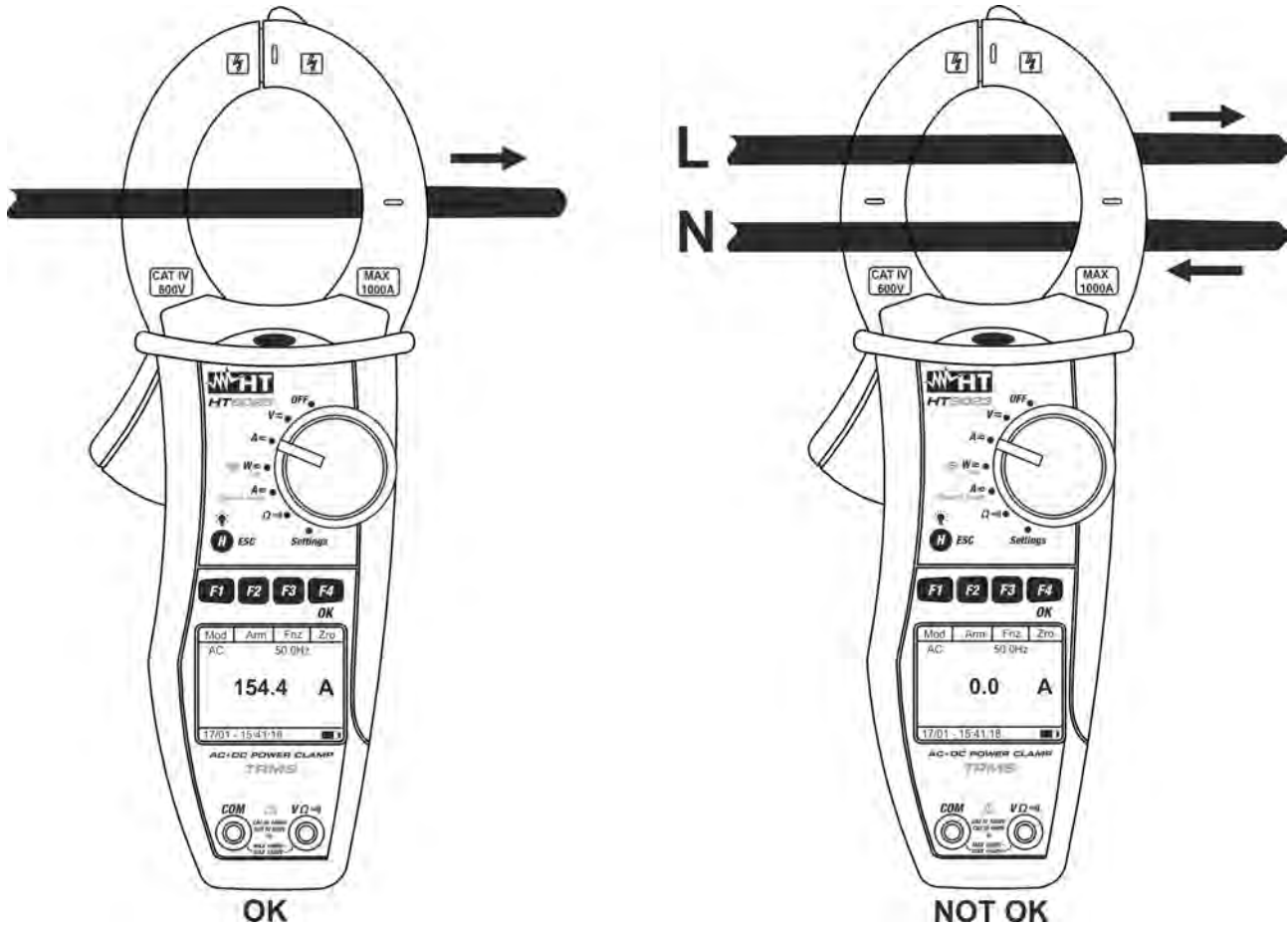

Fig. 10: AC and AC + DC current measurement

1. Positioning the selector switch to “A_~”, the screen nearby will appear.

Mod	Har	Fnc	Zro
AC		< 42.5	Hz
		0.0	A
17/01 - 18:34:23			

2. Press **F1 (Mod)** to open the drop-down menu shown on the screen nearby and select the “**AC**” or “**AC+DC**” option with the same key

3. Press **F4 (OK)** to confirm. The instrument goes into AC current measurement mode

4. Press **F4 (Zro)** to perform the zero of value at display in order to delete the residual magnetization

Mod	Har	Fnc	OK
AC		< 10.5 Hz	
DC			
AC+DC			
Help			
0.0		A	
17/01 – 18:34:23			

5. Connect the cable to the middle of the clamp jaws, in order to get accurate measurements (see Fig. 10 – left part). Use the marks as a reference (see Fig. 2)

6. The screen shows an example of AC current measurement. The instrument allows the evaluation of possible DC components overlapped on a generic alternate waveform signal (AC+DC) and this can be very useful for measurements on impulsive signals typically of no-linear loads (e.g.: welders, electric ovens, etc.)

Mod	Har	Fnc	Zro
AC		50.0 Hz	
100.0		A	
17/01 – 18:34:23			

7. Press **F3 (Fnc)** to open the drop-down menu shown on the screen aside. At each subsequent pressure of key **F3**, the cursor will scroll through the available items, as follows:

- **Max**: it constantly displays the maximum value of AC + DC current
- **Min**: it constantly displays the minimum selected value of AC + DC current
- **Cr+**: it constantly displays the maximum positive crest value
- **Cr-**: it constantly displays the minimum negative crest value
- **RST**: (RESET) it deletes all stored Max, Min, Cr+ and Cr- values and re-start with a new measure
- **Esc**: it goes back to a normal measuring mode

Mod	Har	Fnc	OK
	AC	Max	
		Min	
		Cr+	
		Cr-	
		RST	
		Esc	
100		A	
17/01 – 18:34:23			



CAUTION

- Always carry out current zeroing before clamping the cable
- The measurement of the 4 Max, Min, Cr+ and Cr- values is simultaneous, regardless of the one displayed.

8. Pressing **F4 (OK)**, the selected item is confirmed. Nearby an example of measurement with active Max function. The display shows the active function.

Mod	Har	Fnc	Zro
AC		50.0 Hz	
Max			
120.0		A	
17/01 – 18:34:23			

9. For the use of HOLD and backlight features see § 4.4

5.5.1. Current Harmonics measurement

1. Press the **F2 (Har)** key to select the screen of current harmonics as shown nearby. Press again the **F2 (RMS)** to go back to current measurement screen

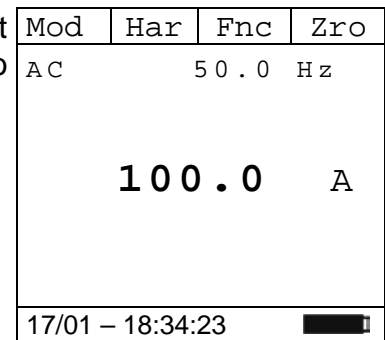

2. Pressing **F1 (◀)** or **F4 (▶)** it is possible to move the cursor over the graph and select the harmonic to be measured. The correspondent absolute or percentage value of harmonic current is displayed. It is possible to measure up to the 25th harmonic

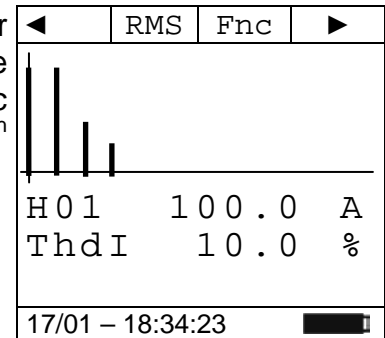

3. Press **F3 (Fnc)** to open the drop-down menu shown on the screen aside. At each subsequent pressure of key **F3**, the cursor will scroll through the available items as follows:
 - **Max**: it constantly displays the maximum RMS value of the selected current harmonic
 - **Min**: it constantly displays the minimum RMS value of the selected current harmonic
 - **Abs**: it displays the absolute value of the harmonics
 - **%**: it displays the value of the harmonics as percentage value with respect to the fundamental
 - **RST**: (RESET) it deletes all stored Max, Min values and re-start with a new measure
 - **Esc**: it goes back to a normal measuring mode

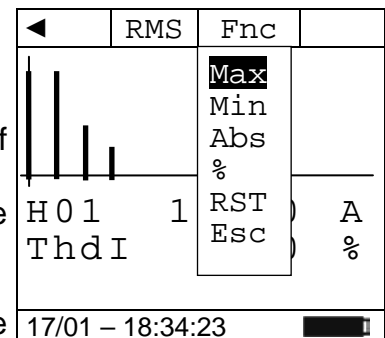

CAUTION

Since the menu contains functions with a different meaning (Max-Min and Abs-%), it is necessary to enter the menu twice: once for displaying Abs or % values and second time to enable the Max or Min functions.

4. Pressing **F4 (OK)**, the selected item is confirmed. Nearby, an example of measurement with active Max function. The display shows the active function.

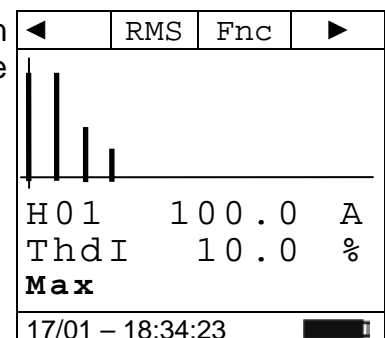

5. For the use of HOLD and backlight features see § 4.4

5.6. DYNAMIC INRUSH CURRENT MEASUREMENT



CAUTION

- The maximum measurable AC or AC+DC current is 1000A. Do not measure currents exceeding the limits given in this manual. Exceeding these limits could result in electrical shocks to the user and damage to the instrument.
- We recommend holding the clamp respecting the safety area created by the hand protection (see Fig. 3).
- Currents <2A are zeroed.

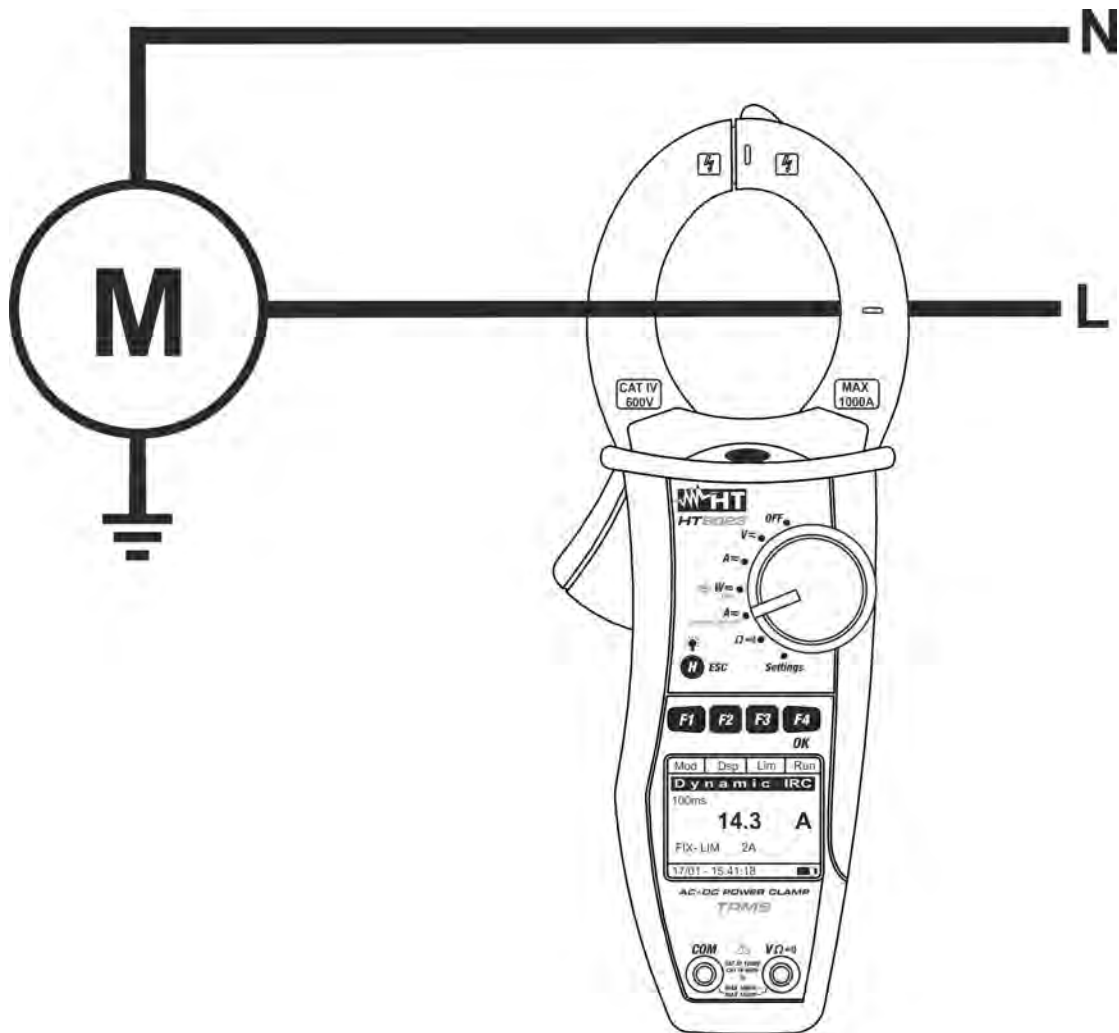

Fig. 11: Dynamic Inrush current measurement

1. Positioning the selector switch to “A \approx Dynamic Inrush”, the screen nearby will appear

Mod	Dsp	Lim	Run
D y n a m i c I R C			
---			A
F I X - L I M		2 A	
17/01 - 18:34:23			

2. Press **F1 (Mod)** to select the inrush current measurement

Mod	Dsp	Lim	OK

between the “**Inrush 100A**” (for inrush current <100A) or “**Inrush 1000A**” (for inrush current <1000A) options as shown asides **F4 (OK)** to confirm. Select the “Zro” option to deleting any possible residual magnetization

3. Press the **F4 (OK)** key to confirm. The instrument goes into inrush current measurement mode

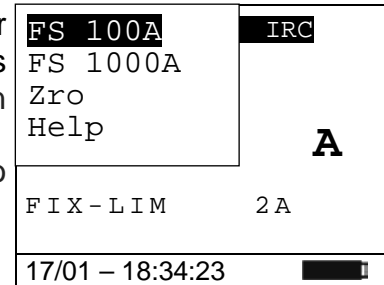

4. Press **F3 (Lim)** for the setting of limit threshold value on inrush current as shown aside
5. Press **F2 (◀)** or **F3 (▶)** to set the reference threshold for the saving of event (**2A ÷ 90A** for “Inrush 100A” and **5A ÷ 900A** for “Inrush 1000A”)
6. Press **F4 (OK)** to confirm and return to main screen

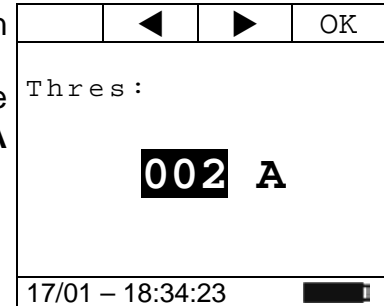

7. Connect the cable to the middle of the clamp jaws, in order to get accurate measurements (see Fig. 11). Use the marks as a reference (see Fig. 2)

8. Press **F4 (Run)** key to start the detection of the inrush current event. Press **F4 (Stp)** to stop the detection of the inrush current event in any time. After the detection of the event (when the measured current is over the limit threshold), **the measurement is automatically stopped** by the instrument and the maximum RMS value in 100ms is displayed as shown aside

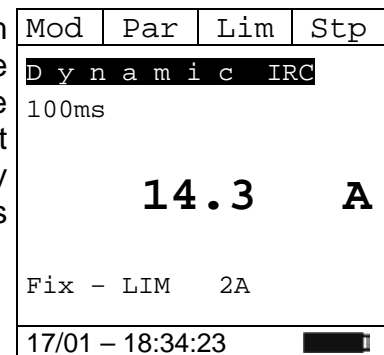

9. Press **F2 (Dsp)** to select the available values, as follows:
 - **PK** → Peak value in **1ms**
 - Max RMS value in **16.7ms**
 - Max RMS value in **20ms**
 - Max RMS value in **50ms**
 - Max RMS value in **100ms**
 - Max RMS value in **150ms**
 - Max RMS value in **200ms**

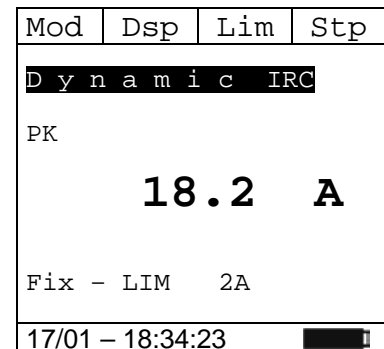

10. Press the **F4 (Sav)** key to save the measurement result within the IRC memory (see § 4.4.6). It is possible to save up to 20 IRC measurements in the memory. Then the message "MEM FULL" is shown in the lower part of the display

Mod	Par	Lim	Run
D y n a m i c IRC			
100ms			
-----			A
Fix - LIM 2A			
17/01 - 18:34:23 █			

11. Press **F4 (Run)** to start a new measurement or move the selector to exit from the function

5.7. DC POWER AND ENERGY MEASUREMENT

CAUTION



- The maximum DC input voltage is 1500V and the maximum measurable DC current is 1000A. Do not measure voltages and currents exceeding the limits given in this manual. Exceeding these limits could result in electrical shocks to the user and damage to the instrument
- We recommend holding the clamp respecting the safety area created by the hand protection (see Fig. 3)

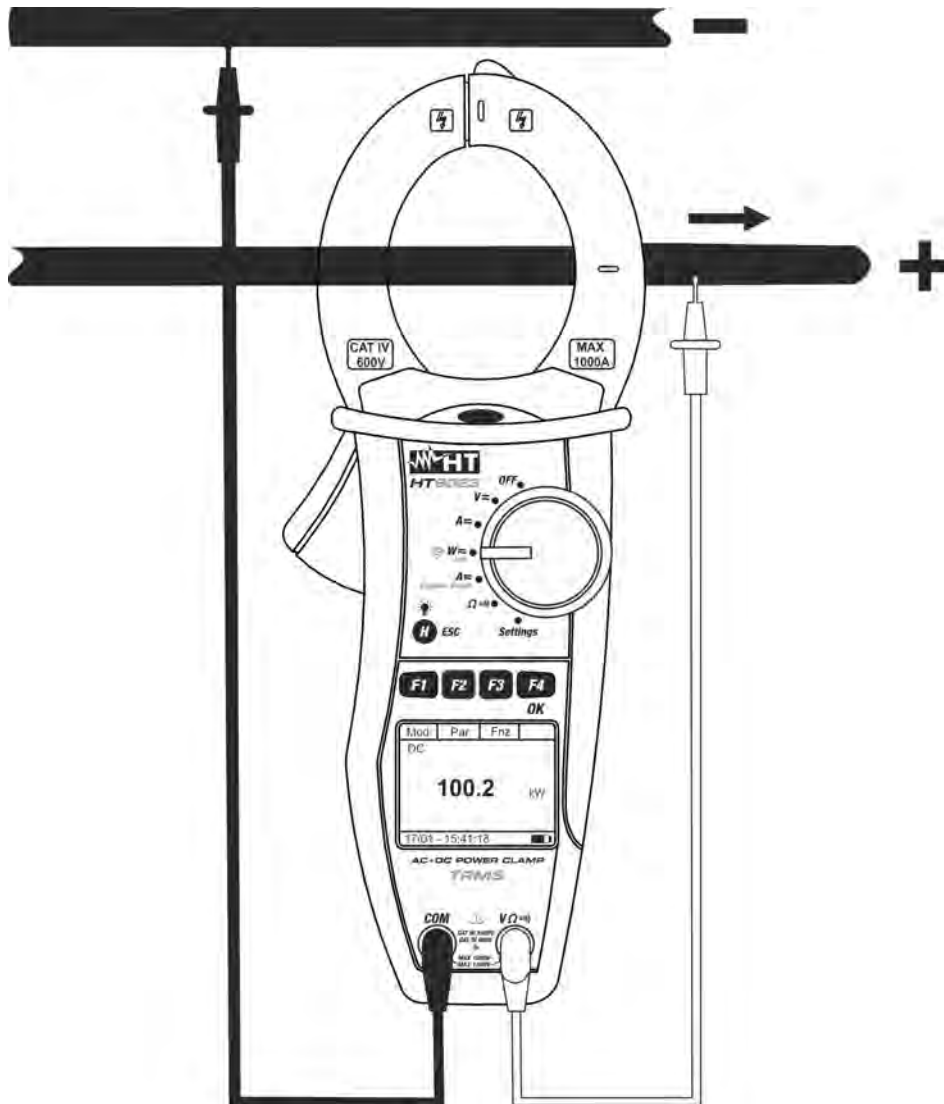

Fig. 12: DC power/energy measurement

1. After positioning the selector switch to “**W**”, the screen aside will appear.

Mod	Par	Fnc	Zro
AC+DC	< 42.5	Hz	
---			kW
---			kVar i
---			kVA
			1 P
17/01 - 18:34:23			

- Press **F1 (Mod)** to open the drop-down menu shown on the screen aside and select the “**DC**” option with the same key
- Press **F4 (OK)** to confirm. The instrument goes into DC current measurement mode

Mod	Par	Fnc	OK
AC+DC	1P	< 42.5	Hz
AC+DC	3P		kW
DC			kV a r i
Online			kVA
Help			
Zro			
Esc			

- Select the “**Zro**” option to reset the values on the display by deleting the residual magnetization on the DC current. Select the “**Online**” option to activate the real-time display of the parameters with WiFi connection of the instrument to a PC and TopView software or with connection to mobile devices via the HTAnalysis APP (see § 6.2)

Mod	Par	Fnc	
DC			
		0.00	kW
17/01 – 18:34:23			

- Connect red cable to input lead **VΩ[Ⓜ]** and black cable to input lead **COM**. Position red lead to “+” and black lead to “-” then connect “+” cable to the clamp jaws, respecting the direction of current indicated by the arrow (see Fig. 12). Connect the cable to the middle of the clamp jaws, in order to get accurate measurements. Use the marks as a reference (see Fig. 2)

- The value of DC power is displayed expressed in kW. Press **F2 (Par)** to open the drop-down menu shown on the screen aside and select the “**Volt/Curr**” option for the DC voltage and current measurement. Confirm with **F4 (OK)**. The following screen is displayed:

Mod	Par	Fnc	OK
	Power		
	Volt/Curr		
	Energy		
		1.60	kW
17/01 – 18:34:23			

- The screen shows an example of DC Voltage and Current measurements.

Mod	Par	Fnc	
DC			
		80.0	V
		20.0	A
17/01 – 18:34:23			

8. Press **F2 (Par)** to open the drop-down menu shown on the screen aside and select the “**Energy**” option for the DC energy measurement. Confirm with **F4 (OK)**. The following screen is displayed

Mod	Par	Fnc	OK
	Power Volt/Curr Energy		
	1.00		kW
17/01 – 18:34:23			

9. Press **F3 (Fnc)**, select the “**Start Log**” option and confirm with **F4 (OK)** key in order to activate the energy measurement with set integration period (see § 4.4.3)

Mod	Par	Fnc	OK
	Max Min RST Start Log Snapshot Download Esc		
	0		
17/01 – 18:34:23			

10. The “**Wait**” message is shown on the display. The instrument puts itself on hold status and activates the recording at the next “00” instant

Mod	Par	Fnc	
DC			
	0.00		kWh
	Wait		
17/01 – 18:34:23			

11. With recording in progress, the message “**Rec**” is shown on the display. Press the **F3 (Fnc)** key to select the “**Info**” option and confirm with the **F4 (OK)** key to view the registration information. The followed screen is shown on the display

Mod	Par	Fnc	
DC			
	Stop Log Info Esc		
	3.20		kWh
	Rec		
17/01 – 18:35:00			

12. The followed parameters are indicated:
- Date/time of start recording
 - Set integration period
 - Number of saved period until this moment
 - Recording autonomy

			Esc
	Start:		
	17/01- 18:35:00		
	Int. Period: 005		
	N.Period: 00054		
	Autono: 00d/10h		
17/01 – 18:37:43			

13. Press the **F3 (Fnc)** key, select the "**Stop Log**" option and confirm with the **F4 (OK)** key to end the energy measurement. **The recording is automatically saved in the internal memory** of the instrument and the reference is visible in the "Memory REC" section of the instrument (see § 4.4.5)

Mod	Par	Fnc	
DC		Stop Log	
		Info	
		Esc	
6 . 4 0 kW			
Rec			
17/01 – 18:35:00			

14. While measuring DC Power, press **F3 (Fnc)** to open the drop-down menu shown on the screen aside. At each subsequent pressure of **F3**, the cursor will scroll through the available items, as follows:

- **Max**: it constantly displays the maximum value of the measured parameter
- **Min**: it constantly displays the minimum value of the measured parameter
- **RST**: (RESET) it deletes all stored Max, Min values and re-start with a new measure
- **Start Log** → start a new recording with integration period set in § 4.4.3
- **Snapshot** → it allows the saving of an instant sampling whose reference is visible in the "Memory REC" section of the instrument (see § 4.4.5)
- **Download** → it allows to perform the WiFi data transfer to PC of saved data via TopView software or to mobile devices via APP HTAnalysis (see § 6.1)
- **Esc**: it goes back to a normal measuring mode

Mod	Par	Fnc	OK
		Max	
		Min	
		RST	
		Start Log	
		Snapshot	
		Download	
		Esc	
17/01 – 18:34:23			

15. By pressing **F4 (OK)**, the selected item is confirmed. Nearby, an example of measurement with active Max function. The display shows the active function.

Mod	Par	Fnc	
DC		Max	
2 . 4 0 kW			
17/01 – 18:34:23			

16. For the use of HOLD and backlight features see § 4.4

5.8. AC AND AC+DC POWER AND ENERGY MEASUREMENT

CAUTION



- The maximum AC/AC+DC input voltage is 1000V and the maximum measurable AC/AC+DC current is 1000A. Do not measure voltages and currents exceeding the limits given in this manual. Exceeding these limits could result in electrical shocks to the user and damage to the instrument
- We recommend holding the clamp respecting the safety area created by the hand protection (see Fig. 3)

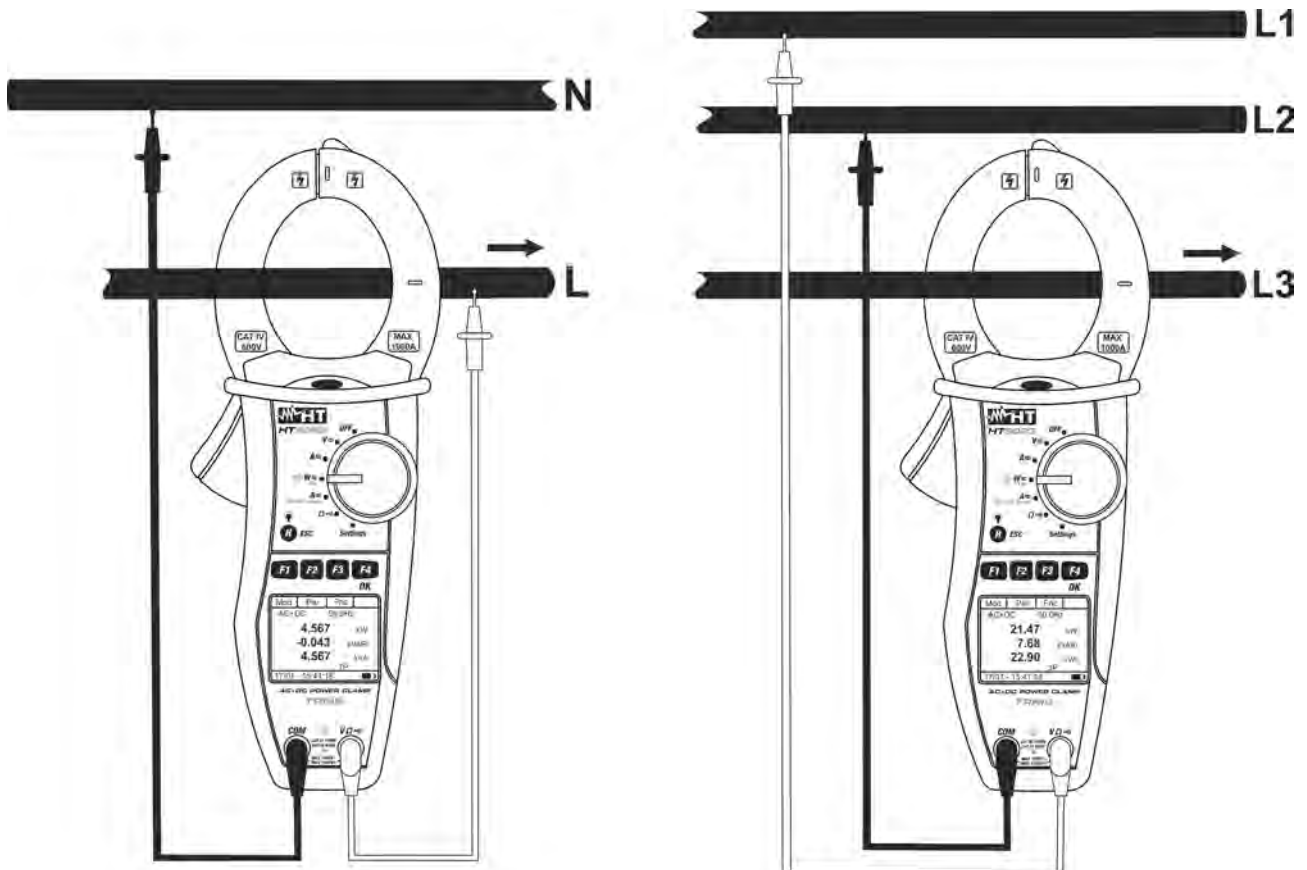

Fig. 13: AC/AC+DC power measure on Single phase and balanced Three phase systems

1. After positioning the selector switch to “**W_~**”, the screen aside will appear.

Mod	Par	Fnc	
AC+DC	< 42.5	Hz	
---			kW
---			kV a r i
---			kVA
			1 P
17/01 - 18:34:23			█

2. Press **F1 (Mod)** to open the drop-down menu shown on the screen aside and select the “**AC+DC 1P**” (Single phase measurement) or “**AC+DC 3P**” (balanced Three phase measurement) options with the same key. The “**1P**” or “**3P**” symbols are displayed.

Mod	Par	Fnc	OK
AC+DC 1P		42.5 Hz	
AC+DC 3P			
DC		kW	
Online		kVar i	
Help		kVA	
Zro			
Esc			

3. Press **F4 (OK)** to confirm. The instrument goes into AC+DC current measurement mode

4. Select the “**Zro**” option to reset the values on the display by deleting the residual magnetization on the DC current.

Mod	Par	Fnc	
AC+DC		< 42.5 Hz	
	---		kW
	---		kVar i
	---		kVA
		1 P	
17/01 – 18:34:23			

5. Select the “**Online**” option to activate the real-time display of the parameters with WiFi connection of the instrument to a PC and TopView software or with connection to mobile devices via the HTAnalysis APP (see § 6.2)

6. Connect red cable to input lead **VΩ⁾⁾⁾** and black cable to input lead **COM** then perform the connection as indicated in Fig. 13 depending on the type of system under test. Put the phase cable into the clamp jaws respecting the direction of current indicated by the arrow (see Fig. 13). Connect the cable to the middle of the clamp jaws, in order to get accurate measurements. Use the marks as a reference (see Fig. 2)

7. The value of AC powers (active , reactive and apparent) is displayed. The instrument allows the evaluation of possible DC components overlapped on a generic alternate waveform signal (AC+DC) and this can be very useful for measurements on impulsive signals typically of no-linear loads (e.g.: welders, electric ovens, etc.)

Mod	Par	Fnc	OK
	P-Q-S		
	PF-DPF		
	Volt/Curr		
	Harm Voltage		
	Harm Current		
	Energy		
		1 P	
17/01 – 18:34:23			

Press **F2 (Par)** and select with the same key the “**PF-DPF**” option for the power factor (PF) and Cosphi (DPF) measurement. Confirm with **F4 (OK)**. The following screen is displayed

8. The screen shows an example of PF and DPF measurement. The “**i**” and “**c**” symbols mean respectively the inductive or capacitive nature of the load.

Mod	Par	Fnc	
AC+DC		50.0 Hz	
	PF	0.94	i
	DPF	0.94	i
		1 P	
17/01 – 18:34:23			

9. Press **F2 (Par)** to open the drop-down menu shown on the screen aside and select the “**Volt/Curr**” option for the voltage and current measurement. Confirm with **F4 (OK)**. The following screen is displayed.

Mod	Par	Fnc	OK
	P-Q-S		
	PF-DPF		
	Volt/Curr		
	Harm Voltage		
	Harm Current		
	Energy		
17/01 – 18:34:23			

10. Nearby, an example of measurement of AC voltage and current in a single phase system.

Mod	Par	Fnc	
	AC	50.0	Hz
	229.7		V
	99.6		A
		1 P	
17/01 – 18:34:23			

11. Press **F2 (Par)** to open the drop-down menu shown on the screen aside and select the “**Harm Voltage**” for the reading of AC+DC voltage harmonic value. Confirm with **F4 (OK)**. The following screen is displayed.

Mod	Par	Fnc	OK
	P-Q-S		
	PF-DPF		
	Volt/Curr		
	Harm Voltage		
	Harm Current		
	Energy		
17/01 – 18:34:23			

12. Pressing **F1 (◀)** or **F4 (▶)**, it is possible to move the cursor over the graph and select the harmonic to be measured. The correspondent absolute or percentage value of harmonic voltage is displayed. It is possible to measure up to the 25th harmonic.

◀	Par	Fnc	▶
	h05	2.3	V
	ThdV	2.4	%
17/01 – 18:34:23			

13. Press **F2 (Par)** to open the drop-down menu shown on the screen aside and select the “**Harm Current**” for the reading of current harmonic value. Confirm with **F4 (OK)**. The following screen is displayed.

Mod	Par	Fnc	OK
	P-Q-S		
	PF-DPF		
	Volt/Curr		
	Harm Voltage		
	Harm Current		
	Energy		
17/01 – 18:34:23			

14. Pressing **F1** (◀) or **F4** (▶) it is possible to move the cursor over the graph and to select the harmonic to be measured. The correspondent absolute or percentage value of harmonic current is displayed. It is possible to measure up to the 25th harmonic

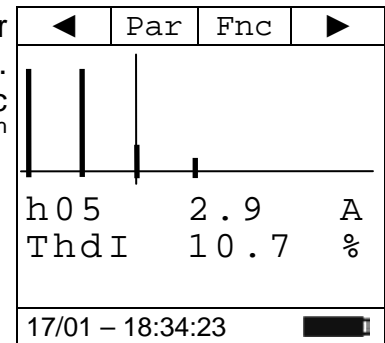

15. Press **F3** (**Fnc**) to open the drop-down menu shown on the screen aside. At each subsequent pressure of key **F3**, the cursor will scroll through the available items, as follows:
- **Max**: it constantly displays the maximum RMS value of the selected voltage or current harmonic
 - **Min**: it constantly displays the minimum RMS value of the selected voltage or current harmonic
 - **Abs**: it displays the absolute value of the harmonics
 - **%**: it displays the value of the harmonics as percentage value with respect to the fundamental
 - **RST**: (RESET) it deletes all stored Max, Min values and re-start with a new measure
 - **Esc**: it goes back to a normal measuring mode

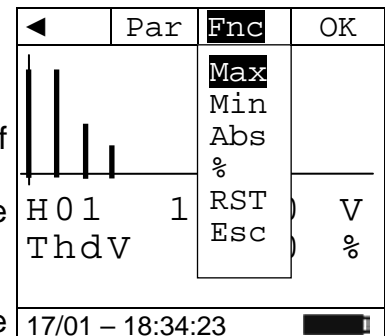

CAUTION

Since the menu contains functions with a different meaning (Max-Min and Abs-%), it is necessary to enter the menu twice: once for displaying Abs or % values and second time to enable the Max or Min functions.

16. Pressing **F4** (**OK**), the selected item is confirmed. Nearby, an example of current harmonic measurement with active Max function. The display shows the active function.

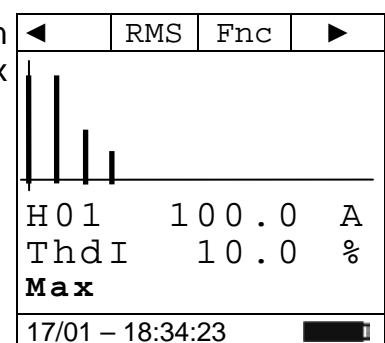

17. Press **F2** (**Par**) to open the drop-down menu shown on the screen aside and select the “**Energy**” option for the energy measurement. Confirm with **F4** (**OK**). The following screen is displayed:

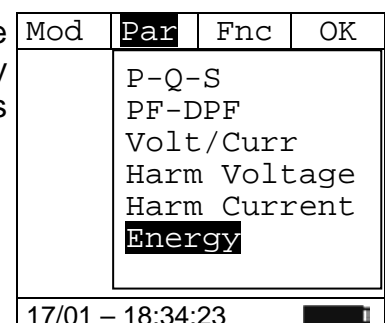

18. Press **F3 (Fnc)**, select the **"Start Log"** option and confirm with **F4 (OK)** key in order to activate the energy measurement with set integration period (see § 4.4.3)

Mod	Par	Fnc	OK
AC+DC		Max	
- - - -		Min	
- - - -		RST	
- - - -		Start Log	
		Snapshot	
		Download	
		Esc	
17/01 - 18:34:23			

19. The **"Wait"** message is shown on the display. The instrument puts itself on hold status and **activates the recording at the next "00" instant**

Mod	Par	Fnc	
AC+DC			
- - - -			kWh
- - - -			kVar h
- - - -			kVarch
Wait			
17/01 - 18:34:23			

20. With recording in progress, the message **"Rec"** is shown on the display. Press the **F3 (Fnc)** key to select the **"Info"** option and confirm with the **F4 (OK)** key to view the registration information. The followed screen is shown on the display

Mod	Par	Fnc	
AC+DC		Stop Log	
0.0		Info	
0.0		Esc	
0.00			kVarch
Rec			
17/01 - 18:35:00			

21. The followed parameters are indicated:

- Date/time of start recording
- Set integration period
- Number of saved period until this moment
- Recording autonomy

			Esc
Start:			
17/01- 18:35:00			
Int.Period: 005			
N.Period: 00054			
Autono: 00d/10h			
17/01 - 18:37:43			

22. Press the **F3 (Fnc)** key, select the **"Stop Log"** option and confirm with the **F4 (OK)** key to end the energy measurement. **The recording is automatically saved in the internal memory** of the instrument and the reference is visible in the "Memory REC" section of the instrument (see § 4.4.5)

Mod	Par	Fnc	
AC+DC		Stop Log	
		Info	
		Esc	
2.2			kWh
0.841			kVar h
0.000			kVarch
Rec 1P			
17/01 - 18:35:00			

23. While measuring P-Q-S power or PF-DPF, press **F3 (Fnc)** to open the drop-down menu shown on the screen aside. At each subsequent pressure of **F3**, the cursor will scroll through the available items, as follows:

- **Max**: it constantly displays the maximum value of the measured parameter
- **Min**: it constantly displays the minimum value of the measured parameter
- **RST**: (RESET) it deletes all stored Max, Min values and re-start with a new measure
- **Start Log** → start a new recording with integration period set in § 4.4.3
- **Snapshot** → it allows the saving of an instant sampling whose reference is visible in the "Memory REC" section of the instrument (see § 4.4.5)
- **Download** → it allows to perform the WiFi data transfer to PC of saved data via TopView software or to mobile devices via APP HTAnalysis (see § 6.1)
- **Esc**: it goes back to a normal measuring mode

Mod	Par	Fnc	OK
	A	Max	
		Min	
	21	RST	
		Start Log	
	7	Snapshot	
		Download	
	22	Esc	
17/01 – 18:34:23			

24. Pressing **F4 (OK)**, the selected item is confirmed. Nearby, an example of power measurement with active Max function. The display shows the active function.

Mod	Par	Fnc	Zro
AC		50.0	Hz
Max			
	80.0		V
	20.0		A
		1 P	
17/01 – 18:34:23			

25. For the use of HOLD and backlight features see § 4.4

5.9. RESISTANCE AND CONTINUITY TEST MEASUREMENT



CAUTION

Before attempting any resistance measurement, remove power from the circuit under test and discharge all capacitors, if present.

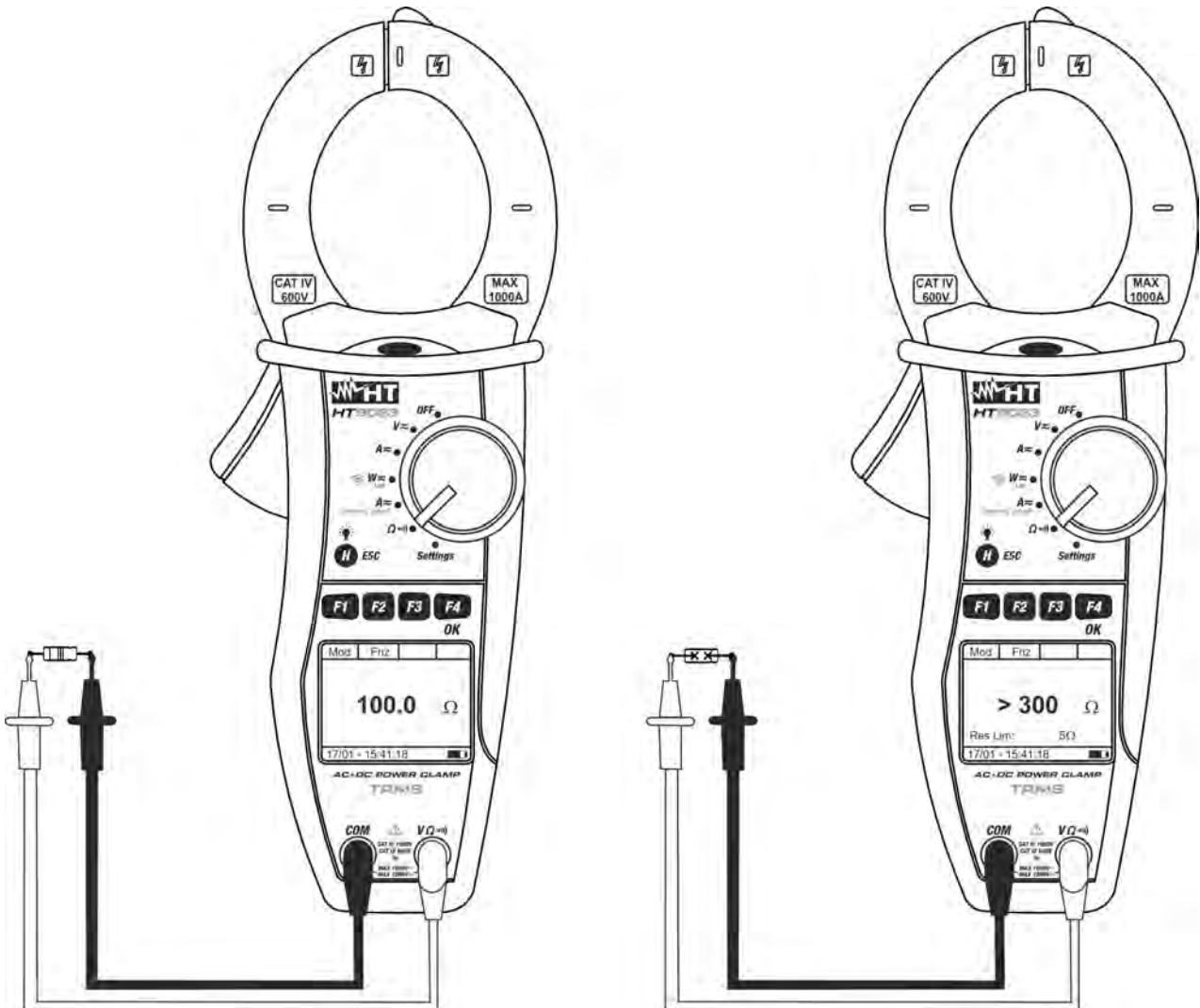
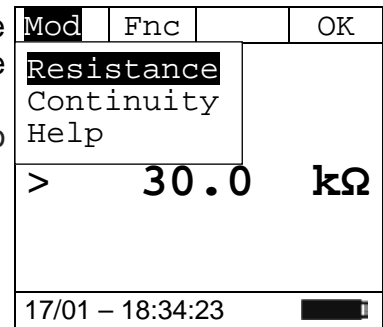

Fig. 14: Resistance measurement

1. Positioning the selector switch to “Ω””, the screen aside will appear.

Mod	Fnc		
> 30.0 kΩ			
17/01 – 18:34:23 ▬			

2. Press **F1 (Mod)** to open the drop-down menu shown on the screen aside and select the “**Resistance**” option with the same key
3. Press **F4 (OK)** to confirm. The instrument goes into resistance measurement mode



4. Connect red cable to the input lead **VΩ** and black cable to the input lead **COM**, then connect the instrument (see Fig. 14 – left part)
5. The screen shows an example of Resistance measurement.

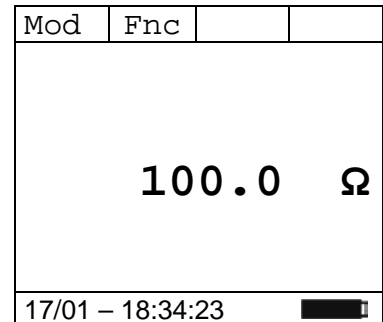

6. Press **F1 (Mod)** to open the drop-down menu shown on the screen aside and select the “**Continuity**” option with the same key
7. Press **F4 (OK)** to confirm. The instrument changes into Continuity test mode and the following screen is displayed. For information on setting of maximum limit on the continuity test, refer to § 4.4.4

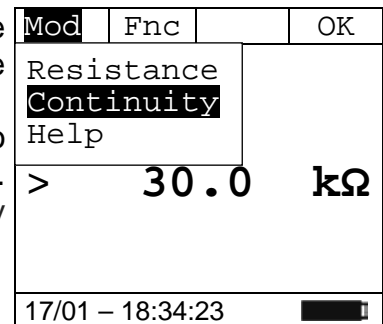

8. While measuring Resistance or Continuity, press **F2 (Fnc)** to open the drop-down menu shown on the screen aside. At each subsequent pressure of **F2**, the cursor will scroll through the available items, as follows:
 - **Max**: it constantly displays the maximum resistance value measured
 - **Min**: it constantly displays the minimum resistance value measured
 - **RST**: (RESET) it deletes all stored Max, Min values and re-start with a new measure
 - **Esc**: it goes back to a normal measuring mode

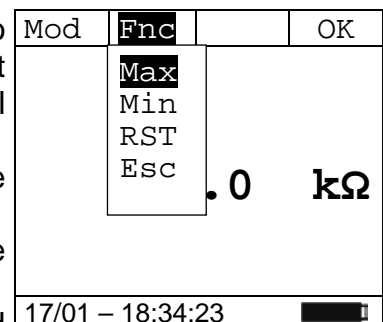

9. Pressing **F4 (OK)**, the selected item is confirmed. Nearby, an example of measurement with active Max function. The display shows the active function.

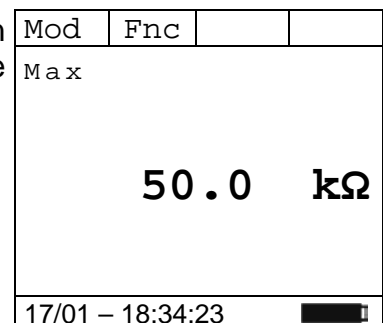

10. For the use of HOLD and backlight features see § 4.4

6. CONNECTION OF INSTRUMENT TO PC AND MOBILE DEVICES

The connection between the PC and the instrument via **WiFi connection** which should be activated during the execution of the operations. Before connecting it is **necessary** that the TopView management software supplied must be installed on the PC and the presence of an active and working WiFi device (e.g: WiFi key) must be checked. The instrument uses WiFi connection in the followed situations:

- Download of the data saved in the REC and IRC Memories (see § 4.4.5 and § 4.4.6) of the instrument (recordings, snapshots and inrush currents) via TopView software
- Real-time reading of the parameters measured via TopView software

6.1. DOWNLOAD SAVED DATA

1. Positioning the selector switch to “**WiFi**”, the screen aside will appear

Mod	Par	Fnc	
AC+DC	< 42.5	Hz	
- - - -			kW
- - - -			kVar i
- - - -			kVA
			1 P
17/01 - 18:34:23			

2. Press the **F3 (Fnc)** key, select the "**Download**" option and confirm with the **F4 (OK)** key. the screen aside will appear

Mod	Par	Fnc	OK
AC+DC	Max		
- - - -	Min		
- - - -	RST		
- - - -	Start Log		
- - - -	Snapshot		
	Download		
	Esc		
17/01 - 18:34:23			

3. The "**Wait**" message indicates that the instrument is activating the internal WiFi connection. After a few seconds the "**Download**" message is shown on the display to indicate that the WiFi connection is active on the instrument as indicated in the followed screen

Wait
17/01 - 18:34:23 

4. Press the **F3 (Esc)** key to disable the WiFi connection and return to the normal measurement

		Esc	
Download			
17/01 - 18:34:23			

5. Search for the “HT9023_xxxxxxxx” instrument in the WiFi device included on the PC and connect it as shown **as an example** in the following Fig. 15

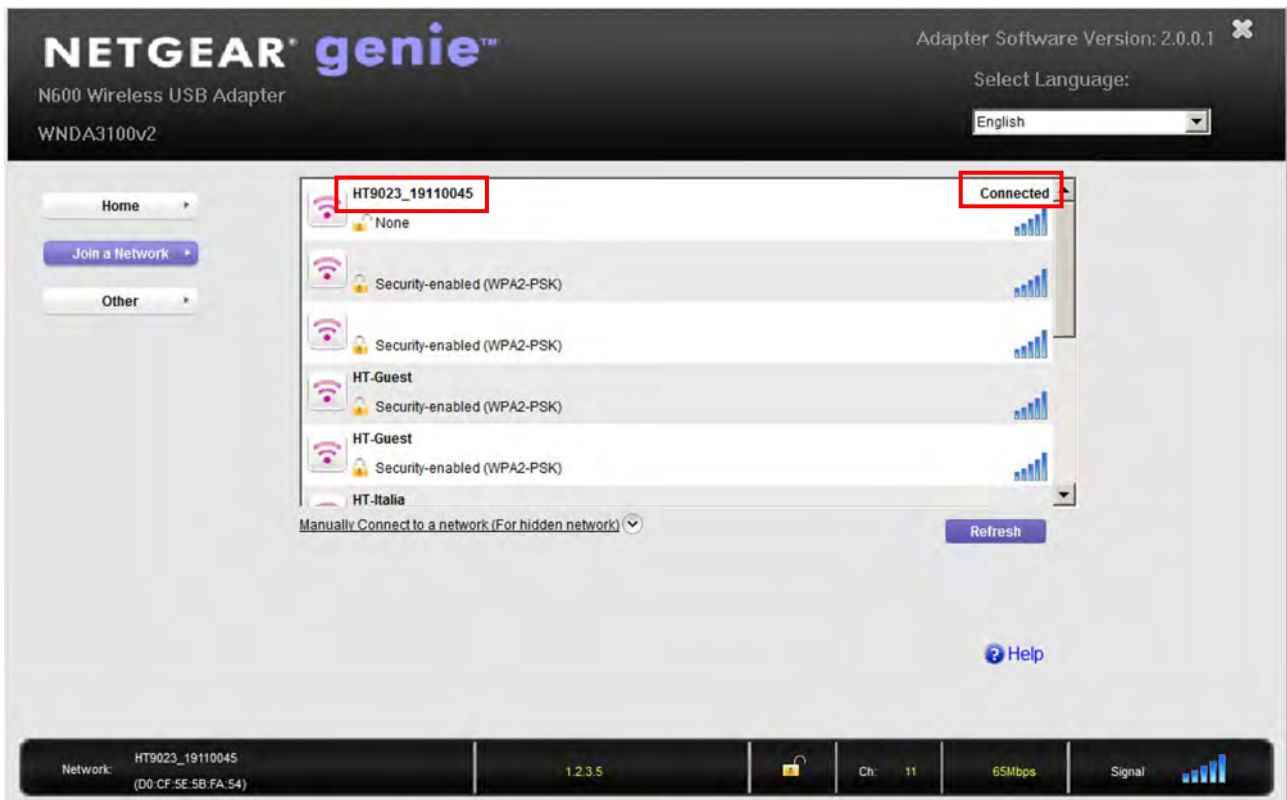

Fig. 15: WiFi connection of instrument to PC (example)

6. Launch the TopView software, open the "PC-Instrument connection" section, run the "Find the instrument" command and check recognition (see Fig. 16)

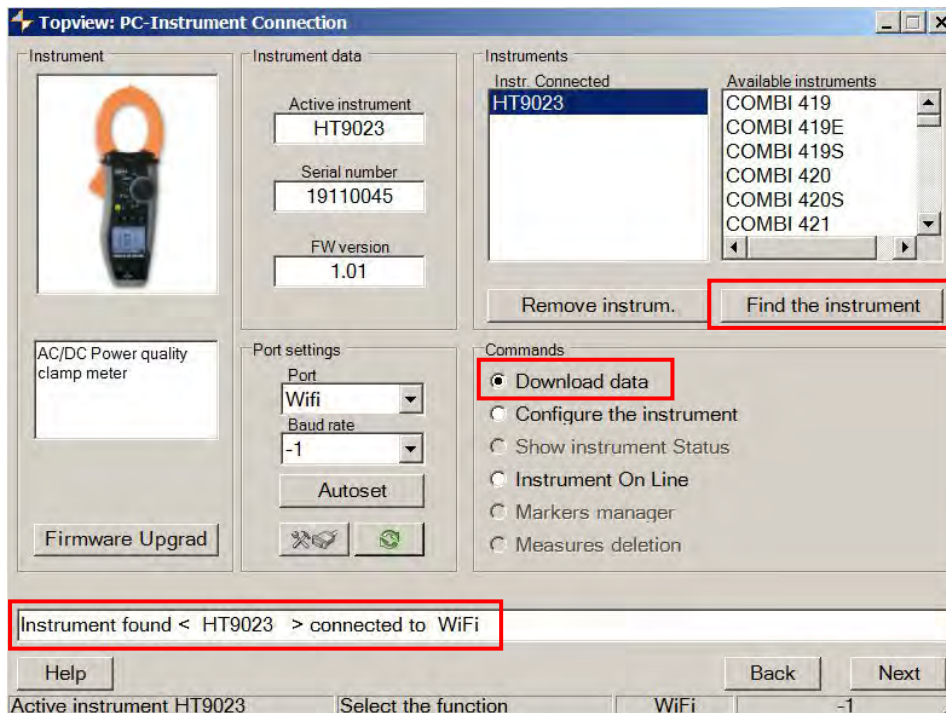

Fig. 16: Instrument detection inside software TopView

7. Click on the “**Next**” button to open the download window (see Fig. 17). Check the measurements you want to download, choose the path where you want to save them and click on the “**Download**” button to start the transfer

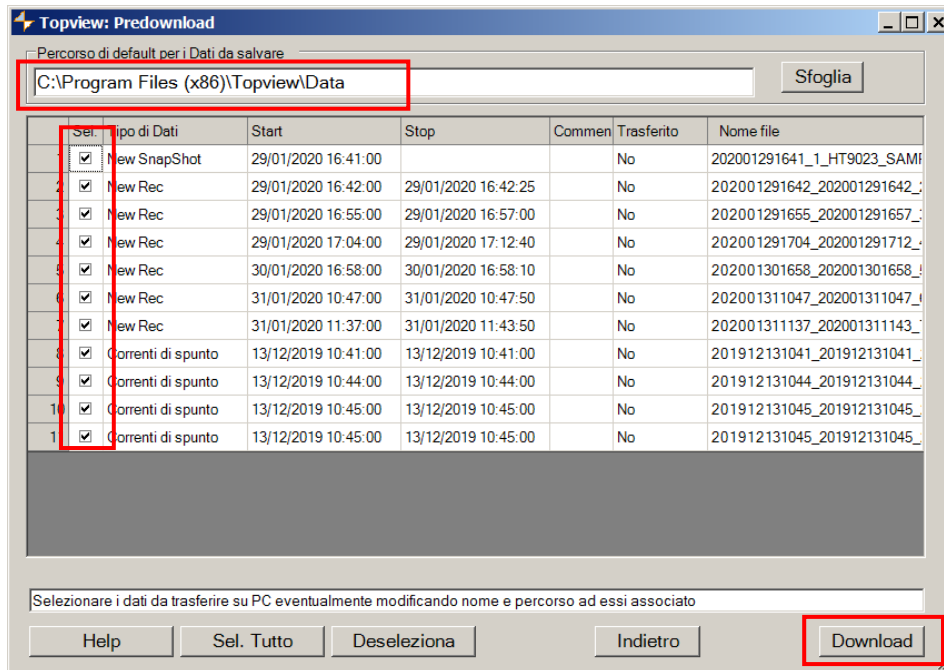

Fig. 17: Selection data for download

8. The software allows to save the followed types of files:
- **HED** and **PER** extension → Viewing parameters of a recording (RECORDING)
 - **DAT** extension → Viewing parameters of instant snapshots (SAMPLING)
 - **IRC** extension → Graphic viewing of inrush currents (IRC)
9. Open the "Data Analysis" section of TopView → click on the “**Import**” command to select and open the downloaded files

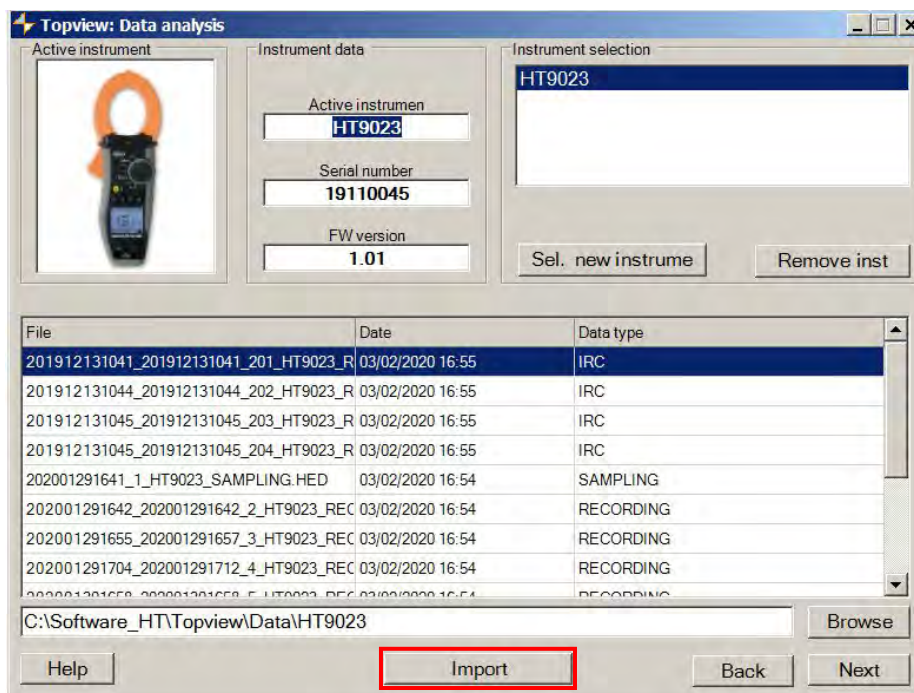

Fig. 18: Open file downloaded to PC

6.2. REAL-TIME READINGS

1. Position the selector on “ W ”, select the F4 (OK) key with the **F1 (Mod)** key and **F4 (OK)** key the "AC + DC 1P", "AC + DC 3P" or "DC" measurements and press the **F4 (OK)** key to confirm
2. Press **F1 (Mod)**, select the "Online" option and press the **F4 (OK)** key to confirm

Mod	Par	Fnc	OK
AC+DC	1P	< 42.5	Hz
AC+DC	3P		
DC			kW
Online			kV a r i
Help			kVA
Zro			
Esc			
			3

3. The "Wait" message indicates that the instrument is activating the internal WiFi connection

Wait
17/01 – 18:34:23

4. After a few seconds the "Onl." message is shown in the lower part of the display to indicate that the WiFi connection is active on the instrument

Mod	Par	Fnc	OK
	AC	< 42.5	Hz
	---		kW
	---		kV a r i
	---		kVA
Onl.			
			17/01 – 18:34:23

5. Connect the instrument to the system under test as shown in § 5.7 or § 5.8
6. Connect the instrument to a PC via WiFi connection and TopView software as shown in § 6.1 and perform the detection
7. Open the "**PC-Instrument connection**" section and select the "Instrument on line" option as shown in the following Fig. 19

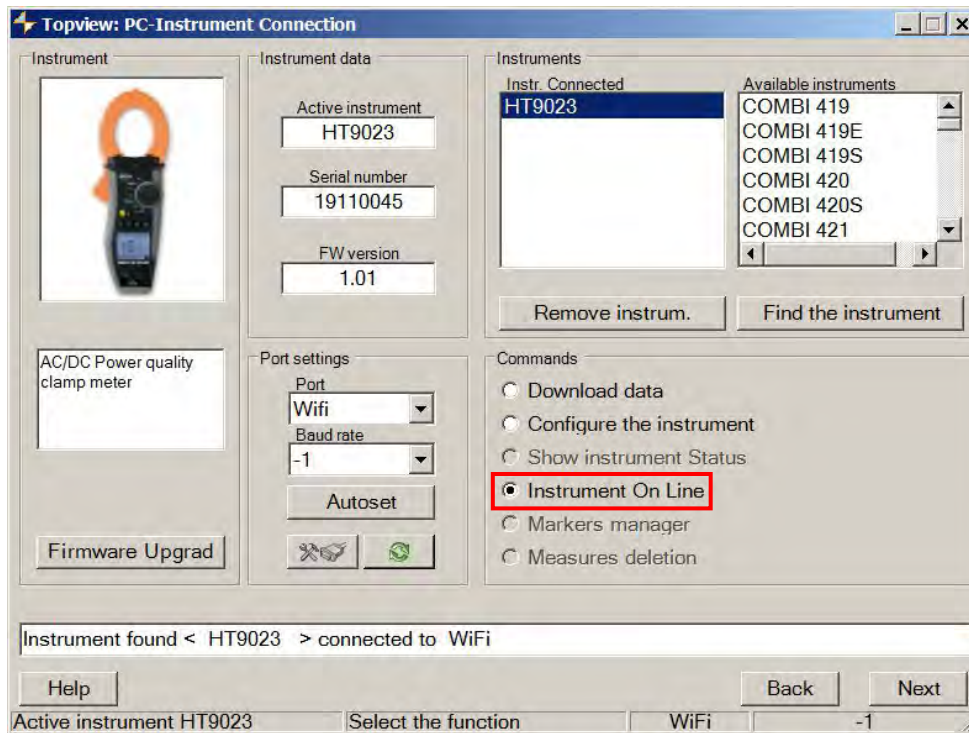

Fig. 19: Real-time connection of the instrument

8. Click on the **"Next"** button to open the real-time visualization of values in the form of tables, waveforms, harmonics graphs and vector diagram, as shown in the Fig. 20

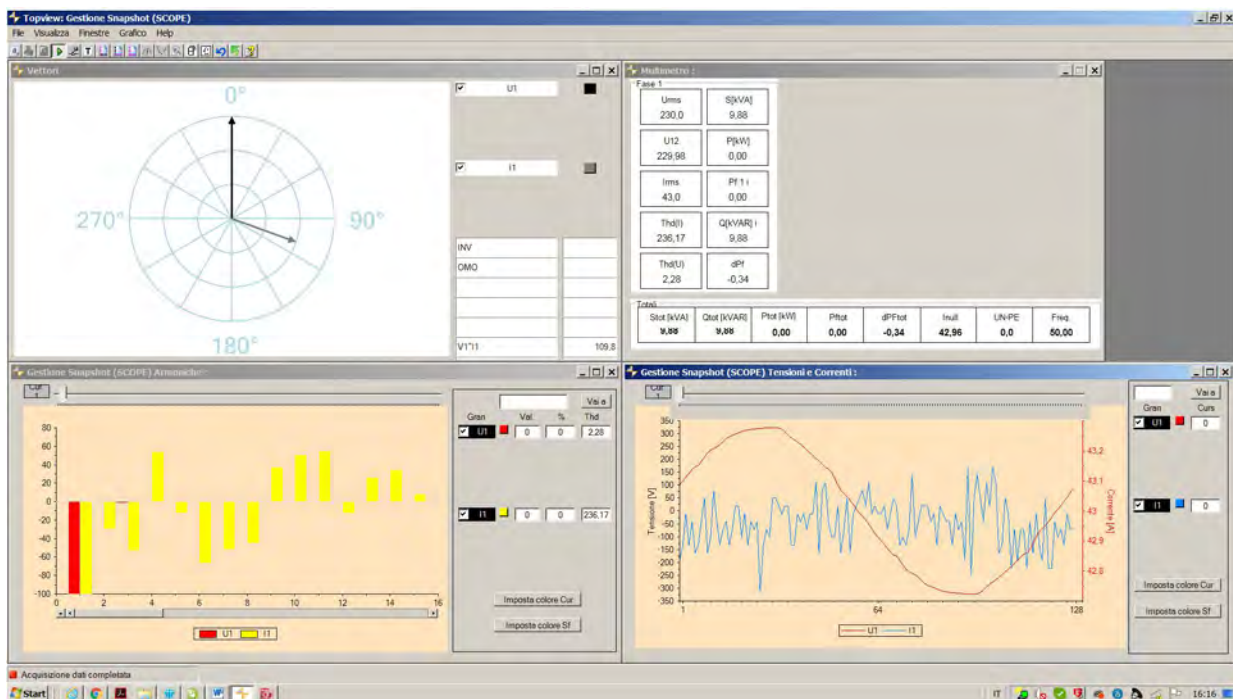

Fig. 20: Real-time visualization of parameters

9. Press the **F1 (Mod)** key, select the **"Esc"** option and press the **F4 (OK)** to confirm the choice in order to exit from the "OnLine" mode. Alternatively, turn the selector to another position

6.3. CONNECTION TO MOBILE DEVICES

The instrument can be connected via WiFi to Android/iOS smartphone and/or tablet devices for the transfer of measurement data via **HTAnalysis** APP. Operate as follows:

1. Download and install the HTAnalysis on the desired mobile device (Android/iOS)
2. Put the instrument in data transfer mode via WiFi (see § 6.1 and § 6.2)
3. Refer to the HTAnalysis instructions for managing the operation

7. MAINTENANCE

7.1. GENERAL INFORMATION

1. The instrument you purchased is a precision instrument. While using and storing the instrument, carefully observe the recommendations listed in this manual in order to prevent possible damage or danger during use.
2. Do not use the instrument in environments with high humidity levels or high temperatures. Do not expose to direct sunlight.
3. Always switch off the instrument after use. In case the instrument is not to be used for a long time, remove the batteries to avoid acid leaks that could damage the instrument's internal circuits.

7.2. BATTERY REPLACEMENT



CAUTION

Only expert and trained technicians should perform this operation.
Before carrying out this operation, make sure you have removed all cables from input leads or the cable under test from clamp jaws.

1. Turn the switch on **OFF** position.
2. Disconnect the cables from the inputs and the cable under test from the clamp jaws.
3. Loosen the screws from battery cover and remove it.
4. Remove the flat batteries from the battery compartment.
5. Insert two new batteries of the same type (see § 8.1.2). Pay attention to the correct polarity.
6. Place the battery cover over the compartment and fasten it with the relevant screws.
7. Do not waste old batteries into the environment. Use the relevant containers for disposal.

7.3. CLEANING THE INSTRUMENT

Use a soft and dry cloth to clean the instrument. Never use wet cloths, solvents, water, etc.

7.4. END OF LIFE



CAUTION: the symbol on the instrument indicates that the appliance and its accessories must be collected separately and correctly disposed of.

8. TECHNICAL SPECIFICATIONS

8.1. TECHNICAL CHARACTERISTICS

Accuracy indicated as $\pm[\%rdg + (\text{num digit} * \text{resolution})]$ referred to $23^{\circ}\text{C} \pm 5^{\circ}\text{C}$, $< 80\%RH$

DC Voltage

Range [V]	Resolution [V]	Accuracy	Overload protection
-1500.0 ÷ 1500.0	0.1	$\pm(1.0\%rdg+3dgt)$	1500VDC

Input impedance: 1M Ω ; Absolute voltage values $<0.3V$ are zeroed

AC, AC+DC TRMS Voltage

Range [V]	Resolution [V]	Accuracy	Overload protection
0.1 ÷ 999.9V	0.1	$\pm(1.0\%rdg+3dgt)$	1000VDC/ACrms

Input impedance: 1M Ω ; Fundamental: 50/60Hz $\pm 15\%$, Bandwidth: 42.5Hz ÷ 1725Hz

Max. Crest Factor: 3 for voltage $\leq 470V_{rms}$, 1.41 for voltage $>470V_{rms}$

Voltage RMS values $<1V$ and values with frequency external range 42.5Hz ÷ 1725Hz are zeroed

DC Voltage: MAX/MIN/CREST (+/-)

Function	Range [V]	Resolution [V]	Accuracy	Response time
MAX,MIN	-1500.0 ÷ 1500.0	0.1	$\pm(3.5\%rdg+5dgt)$	200ms
CREST				1ms

Input impedance: 1M Ω ; Absolute voltage values $<0.3V$ are zeroed

AC, AC+DC TRMS Voltage: MAX/MIN/CREST

Function	Range [V]	Resolution [V]	Accuracy	Response time
MAX,MIN	1.0 ÷ 999.9	0.1	$\pm(3.5\%rdg+5dgt)$	200ms
CREST	-1500.V ÷ 1500.0			1ms

Input impedance: 1M Ω ; Fundamental: 50/60Hz $\pm 15\%$, Bandwidth: 42.5Hz ÷ 1725Hz

Max. Crest Factor: 3 for voltage $\leq 470V_{rms}$, 1.41 for voltage $>470V_{rms}$

MAX/MIN values $<1V$, CREST values <1.4 and MAX/MIN/CREST values with frequency external range 42.5Hz ÷ 1725Hz are zeroed

DC Current

Range [A]	Resolution [A]	Accuracy	Overload protection
0.1 ÷ 999.9A	0.1A	$\pm(2.0\%rdg+5dgt)$	1000ADC/ACrms

AC, AC+DC TRMS Current

Range [A]	Resolution [A]	Accuracy	Overload protection
1.0 ÷ 999.9A	0.1A	$\pm(1.0\%rdg+5dgt)$	1000ADC/ACrms

Fundamental: 50/60Hz $\pm 15\%$, Bandwidth: 42.5Hz ÷ 1725Hz

Max. Crest Factor: 3 for current $\leq 515A_{rms}$, 1.41 for current $>515A$

Current RMS values $<1A$ and values with frequency external range 42.5Hz ÷ 1725Hz are zeroed

AC, AC+DC TRMS Current: MAX/MIN

Function	Range [A]	Resolution [A]	Accuracy	Response time
MAX, MAX	1.0 ÷ 999.9A	0.1A	$\pm(3.5\%rdg+5dgt)$	1s

Fundamental: 50/60Hz $\pm 15\%$, Bandwidth: 42.5Hz ÷ 1725Hz

Max. Crest Factor: 3 for current $\leq 515A_{rms}$, 1.41 for current $>515A$

MAX/MIN values $<1A$ and MAX/MIN values with frequency external range 42.5Hz ÷ 1725Hz are zeroed

Resistance and Continuity test

Range [Ω]	Resolution [Ω]	Accuracy	Overload protection
0.0 Ω ÷ 199.9 Ω	0.1 Ω	$\pm(2.0\%rdg+5dgt)$	1000VDC/ACrms
200 Ω ÷ 1999 Ω	1 Ω		
2.00k Ω ÷ 19.99k Ω	0.01k Ω		
20.0k Ω ÷ 29.9k Ω	0.1k Ω		

Buzzer ON if $R \leq RLIM$, RLIM range: 1 ÷ 150 Ω

Frequency (with test leads/ with jaws)

Range [Hz]	Resolution [Hz]	Accuracy	Overload protection
42.5 ÷ 69.0Hz	0.1Hz	$\pm(1.0\%rdg+5dgt)$	1500VDC 1000ADC/ACrms

Voltage range for frequency measure: 0.5 ÷ 1000V / Current range for frequency measure with jaws: 1 ÷ 1000A

Phase sequence and phase conformity

Range [V]	Frequency [Hz]	Overload protection
100 ÷ 1000	45 ÷ 66	1000VDC/ACrms

Input impedance: 1.3MΩ

Inrush current (DC, AC+DC TRMS)

Range [A]	Resolution [A]	Accuracy (*)	Overload protection
1.0 ÷ 99.9A	0.1A	±(2.0%rdg + 5dgt)	1000ADC/ACrms
10 ÷ 999A	1A		

(*) Accuracy declared for frequency: DC, (50±0.5)Hz, (60±0.5)Hz

Crest factor: 3, Sample frequency: 4kHz, Response time: Peak: 1ms, Max RMS : calculated on: 16.7, 20, 50, 100, 150, 200ms

DC Power

Range [kW]	Resolution [kW]	Accuracy (*)
0.00 ÷ 99.99	0.01	±(3.0%rdg+3dgt)
100.0 ÷ 999.9	0.1	

(*) Accuracy referred for Voltage > 10V, Current ≥ 2A

Active, Apparent Power AC, AC+DC TRMS

Range [kW], [kVA]	Resolution [kW], [kVA]	Accuracy (*)
0.001 ÷ 9.999 (**)	0.001	±(3.0%rdg+10dgt)
10.00 ÷ 99.99	0.01	
100.0 ÷ 999.9	0.1	

(*) Accuracy referred for sinusoidal waveform, 42.5..69Hz, Voltage > 10V, Current ≥ 10A, Pf ≥ 0.5

(**) For Current <10A add ±7%rdg to the accuracy

Reactive Power AC (AC + DC TRMS)

Range [kVAR]	Resolution [kVAR]	Accuracy (*)
0.001 ÷ 9.999 (**)	0.001	±(3.0%rdg+10dgt)
10.00 ÷ 99.99	0.01	
100.0 ÷ 999.9	0.1	

(*) Accuracy referred for sinusoidal waveform, 42.5..69Hz, Voltage > 10V, Current ≥ 10A, Pf ≤ 0.9

(**) For Current <10A add ±4%rdg to the accuracy

Active Energy AC (AC + DC TRMS)

Range [kWh]	Resolution [kWh]	Accuracy (*)
0.001 ÷ 9.999 (**)	0.001	±(3.0%rdg+10dgt)
10.00 ÷ 99.99	0.01	
100.0 ÷ 999.9	0.1	

(*) Accuracy referred for sinusoidal waveform, 42.5..69Hz, Voltage > 10V, Current ≥ 10A, Pf ≥ 0.5

(**) For Current <10A add ±7%rdg to the accuracy

Reactive Energy AC (AC + DC TRMS)

Range [kVARh]	Resolution [kVARh]	Accuracy (*)
0.001 ÷ 9.999 (**)	0.001	±(3.0%rdg+10dgt)
10.00 ÷ 99.99	0.01	
100.0 ÷ 999.9	0.1	

(*) Accuracy referred for sinusoidal waveform, 42.5..69Hz, Voltage > 10V, Current ≥ 10A, Pf ≤ 0.9

(**) For Current <10A add ±4%rdg to the accuracy

Power factor/cosphi

Range	Resolution	Accuracy (*)
0.20i ÷ 1.00 ÷ 0.20c	0.01	±(2.0%rdg+2dgt)

Input impedance: 1MΩ, Accuracy referred for sinusoidal waveform, 42.5..69Hz, Voltage > 10V, Current ≥ 2A

Voltage and Current Harmonics

Fund. Frequency [Hz]	Harmonic order	Resolution	Accuracy (* no zeroed values)
42.5 ÷ 69	0 (DC)	0.1V / 0.1A	±(10.0%rdg+5dgt)
	1 ÷ 25		±(5.0%rdg+5dgt)
	THD%	0.1%	±(10.0%rdg+5dgt)

(*) Voltage harmonics are zeroed in the below conditions:

• 1st harmonic: if value < 1.0V ; DC, 2nd to 25th harmonics: if harmonic value <0.5% of fundamental value or if value <1.0V

(*) Current harmonics are zeroed in the below conditions:

• 1st harmonic: if value <1.0A; DC, 2nd to 25th harmonics: if harmonic value <0.5% of fundamental value or if value <1.0A

8.1.1. Reference guidelines

Safety:	IEC/EN61010-1, IEC/EN61010-2-032
EMC :	IEC/EN61326-1
Technical documentation:	IEC/EN61187
Safety of measuring accessories:	IEC/EN61010-31
Insulation:	double insulation
Pollution level:	2
Measurement category:	CAT IV 600V/CAT III 1000V to ground

8.1.2. General characteristics

Mechanical characteristics

Dimensions (L x W x H):	252 x 88 x 44mm (9 x 3 x 2 in)
Weight (batteries included):	approx 420g (15 ounces)
Jaw opening / Max cable size:	45mm (1.8 in)
Mechanical protection:	IP20

Output interface

Type of connection:	WiFi
---------------------	------

Power supply

Battery type:	2 batteries x 1.5V LR 03 AAA
Battery life:	approx. 40 hours of use in “W _≠ ” position
Auto power OFF:	after 5 min of idleness (disabled)

Memory

Memory capacity:	2MB
------------------	-----

Recordings

Inrush current snapshots saving:	max 20 (each with max 10 events)
Log + Snapshot saving:	max 99 files
Sampling rate:	128 sample/period (basic sample)
Aggregation time (IP):	1s, 5s, 10s, 30s, 60s, 120s, 300s, 600s, 900s
Max Rec autonomy (hours)	~2.1 x PI. e.g: PI=60s → ~126hours ~ 5days

Display

Characteristics:	graphic display 128x128 pixels
Updating frequency:	1time/s

8.2. ENVIRONMENT

8.2.1. Environmental conditions for use

Reference calibration temperature:	23°C ± 5°C (73 ± 41°F)
Operating temperature:	0°C ÷ 40°C (32 ÷ 104°F)
Allowable relative humidity:	<80%RH
Storage temperature:	-10°C ÷ 60°C (14 ÷ 140°F)
Storage humidity:	<70%RH
Max height of use:	2000m (6562ft)

This instrument satisfies the requirements of Low Voltage Directive 2014/35/EU (LVD) and of EMC Directive 2014/30/EU

This instrument satisfies the requirements of 2011/65/EU (RoHS) directive and 2012/19/EU (WEEE) directive

8.3. ACCESSORIES

8.3.1. Accessories provided

- Pair of test leads
- Pair of alligator clips
- Carrying bag
- Batteries
- TOPVIEWS: PC Windows software
- ISO9000 calibration certificate
- User manual on CD-ROM
- Quick reference guide

9. SERVICE

9.1. WARRANTY CONDITIONS

This equipment is guaranteed against material faults or production defects, in accordance with the general sales conditions. During the warranty period (one year), faulty parts may be replaced. The manufacturer reserves the right to decide either to repair or replace the product. In case of returning of the instrument, all transport charges must be paid by the customer. The instrument must be accompanied by a delivery note indicating the faults or reasons of returning. The returned tester must be packed in its original box. Any damage occurred in transit because of lack of original packaging will be debited to the customer. The manufacturer is not responsible for any damage against persons or things. Accessories and batteries are not covered by warranty.

The warranty won't be applied to the following cases:

- Faults due to improper use of the equipment
- Faults due to combination of the tester with incompatible equipment.
- Faults due to improper packaging.
- Faults due to servicing carried out by a person not authorized by the company.
- Faults due to modifications made without explicit authorisation of our technical department.
- Faults due to adaptation to a particular application not provided for by the definition of the equipment or by the instruction manual.

The contents of this manual cannot be reproduced in any form without our authorization.

Our products are patented. Our logotypes are registered. We reserve the right to modify characteristics and prices further to technological developments.

9.2. SERVICE

If the instrument does not operate properly, please check the conditions of batteries and cables before contacting the After-sales Service and replace them, if necessary. Should the instrument still operate improperly, check that the product is operated according to the instructions given in this manual. Should the instrument be returned to the After-sales Service or to a Dealer, transport will be at the Customer's charge. However, shipment shall be agreed in advance. A report shall always be enclosed to a shipment, stating the reasons for the product's return. Use exclusively original packaging for shipment; any damage due to the use of non-original packaging material will be charged to the Customer.

10. APPENDIX – THEORETICAL OUTLINE

10.1. VOLTAGE AND CURRENT HARMONICS

Any periodic non-sinusoidal wave may be represented by a sum of sinusoidal waves, each with a frequency which is a whole multiple of the fundamental, according to the relationship:

$$v(t) = V_0 + \sum_{k=1}^{\infty} V_k \sin(\omega_k t + \varphi_k) \quad (1)$$

where:

V_0 = Average value of $v(t)$

V_1 = Amplitude of the fundamental of $v(t)$

V_k = Amplitude of the k-nth harmonic of $v(t)$

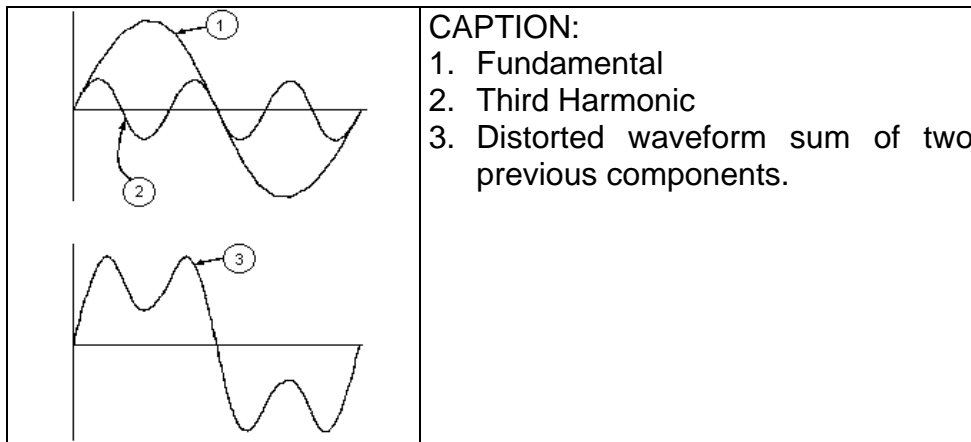

Effect of the sum of 2 multiple frequencies.

For network voltage, the fundamental has a frequency of 50 Hz, the second harmonic has a frequency of 100 Hz, the third harmonic has a frequency of 150 Hz and so on. Harmonic distortion is a continuous problem and must not be confused with short-duration phenomena such as peaks, drops or fluctuations. It can be seen from (1) that each signal consists of the sum of infinite harmonics. However, an order number exists beyond which the value of the harmonics may be considered as negligible.

A fundamental index to detect the presence of harmonics is the THD defined as:

$$THD_v = \frac{\sqrt{\sum_{h=2}^{40} V_h^2}}{V_1}$$

This index takes into consideration the presence of all harmonics, and the more distorted is the waveform, the higher is the index.

Limit values for harmonics

Standard EN50160 prescribes the limits for the Voltage Harmonics that Energy Provider may introduce into the network.

- Under normal operating conditions, at any time in a week, 95% of the efficient values of each harmonic voltage, averaged to 10 minutes, must be lower than or equal to the values indicated in the following Table
- The total harmonic distortion (THD%) of supply voltage must be lower than or equal to 8%.

Odd Harmonics				Even Harmonics	
Not multiple of 3		Multiple of 3		Order h	Relative Voltage %Max
Order h	Relative Voltage %Max	Order h	Relative Voltage %Max		
5	6	3	5	2	2
7	5	9	1,5	4	1
11	3,5	15	0,5	6..24	0,5
13	3	21	0,5		
17	2				
19	1,5				
23	1,5				
25	1,5				

These limits, which theoretically apply only to Electric Power Suppliers, provide anyway a series of reference values within which even the harmonics put into network by users should be kept.

Causes FOR the presence of harmonics

- Any appliance altering the sinusoidal wave or simply using a part of such wave causes distortions to the sinusoid, and hence harmonics
- All current signals are therefore somehow virtually distorted. The most common distortion is the harmonic distortion caused by non-linear loads such as household appliances, personal computers or motor speed adjusters. Harmonic distortion generates significant currents at frequencies which are whole multiples of network voltage. **Harmonic currents have a remarkable effect on neutral conductors of electrical systems.**
- In most countries, the network voltage used is three-phase 50/60Hz, supplied by a transformer with triangle-connected primary circuit and star-connected secondary circuit. The secondary circuit generally generates 230V AC between phase and neutral and 400V AC between phase and phase. Balancing loads for each phase has always been a problem for electrical system designers.
- Approximately ten years ago, in a global balanced system, the vector sum of the currents in the neutral was zero or anyway quite low (in view of difficulty to get a perfect balance). Connected devices were incandescent lights, small motors and other devices that presented linear loads. The result was an essentially sinusoidal current in each phase and a low current on the neutral at a frequency of 50/60Hz.
- “Modern” devices such as TV sets, fluorescent lights, video machines and microwave ovens normally draw current for only a fraction of each cycle, thus causing non-linear loads and, consequently, non-linear currents. All this generates odd harmonics of the 50/60Hz line frequency. For this reason, nowadays the current in the transformers of the distribution boxes contains not only a 50Hz (or 60Hz) component, but also a 150Hz (or 180Hz) component, a 250Hz (or 300Hz) component and other significant harmonic components up to 750Hz (or 900Hz) and above.
- The vector sum of the currents in a global balanced system that feeds non-linear loads may still be quite low. However, the sum does not eliminate all harmonic currents. The odd multiples of the third harmonic (called “TRIPLENS”) are added together in the neutral conductor and can cause overheating even with balanced loads.

Consequence resulting from presence of harmonics

Generally, harmonics of even, 2nd, 4th etc. order do not create problems. Designers must consider the following points when designing a power distribution system containing harmonic currents:

Installation parts	Effects traceable to Harmonics
Fuses	Non-uniform heating of internal fuse element and consequent overheating which can also lead to an explosion of the fuse casing.
Cables	Increase in "body" effect; this means that, for cables with many wires, the internal wires have higher impedance than the external wires. As a consequence, current, which normally distributes along the external surface of the wire, produces: – over-heating of the conductor; – a premature degrading of the cable's insulation; – an increase in line voltage drop.
Neutral conductor	Triple harmonics, odd multiple of three, sum on neutral (instead of nullifying themselves), thus generating a potentially dangerous overheating of the conductor.
Transformers	Increase in copper loss due to a higher TRMS value of the current that circulates on internal circuits, and also due to the "body" effect on protected wires. Increase of iron loss due to hysteresis cycle distortion and due to the generation of leakage currents on the magnetic core. Heating of insulation material due to a possible DC component that can generate saturation of the magnetic core column.
Motors	Increase of loss due to overheating of internal circuits and possible damage of insulation material. The 5 th and 11 th harmonic components generate some abnormal electromagnetic coupling that can increase motor speed.
Re-phasing capacitors	Increase in "parallel resonance" present inside a circuit, due to inductive loads and re-phasing capacitors, when at least one of the harmonics has the same frequency as the resonance phenomenon. Effects of this event can be very dangerous, with explosion of used re-phasing capacitors.
RCD devices	Possible saturation of current sensing toroidal transducers resulting in malfunction, both in terms of untimely tripping and increase of the tripping threshold.
Energy disk counters	Increased rotation speed of a disk resulting in measurement errors (especially in case of low power factor loads).
Power controls switch	Reduction of electric duration of contact surfaces.
UPS	Reduced power generation from UPS.
Electronics devices	Internal damage of electronic components not protected by suitable devices.