



Bonetti Rubinetterie Valduggia S.r.l.

INDUSTRY CATALOGUE

EDITION 11

MODVLS



A HISTORY OF EXCELLENCE AND INNOVATION



Quality, technical development, flexibility, customer satisfaction: these are the cornerstones of the company policy and the foundations of BRV's success on the international and national market.

BRV Bonetti Rubinetterie Valduggia, in its current corporate configuration, was born in 1970, thanks to the managerial skills of two young entrepreneurs, Roberto Villa and Adriano Scovenna, as a transformation of an artisan and family business that had been active for some time, founded by Giuseppe Bonetti. The modern structure, with its workplaces made on a human scale, is located among the beautiful hills at the foot of the western Italian Alps, employing about 65 employees in its single production site in Valduggia for a total turnover of 30 million euros. We export 85% of our production to more than 50 countries and are present in the most important international fairs.

In 1997 BRV obtained UNI EN ISO 9002 certification. Since 2003 BRV has been UNI EN ISO 9001 certified and many of its products are approved by various international and national institutes such as WRAS, DVGW, CEN etc.



Every aspect related to corporate quality is implemented and fulfilled daily in accordance with the ISO 9000 standard, to monitor the compliance of all operations: from design to customer service.

A profound and careful corporate renewal started in 2005 allowed BRV to achieve excellent commercial results with an average annual growth rate (CAGR) of 11% in the period 2005-2022. The continuous innovation and modernization of production processes, the high professional level of the workforce and the very efficient activity of the technical and R&D departments allow BRV to design, develop and produce particularly innovative items appreciated by the market.

The considerable success that BRV has achieved on technologically advanced international markets testifies to the effectiveness of its industrial and commercial policy. Modern and flexible managerial criteria allow BRV to respond promptly and adequately to the various market requests.



HEATING AND COOLING	6
ModvBox multi-zone distribution box	6
DN20 Pump units, equipments and zone manifolds	8
DN25 Pump units, equipments and zone manifolds	24
Buffer tanks for heating & cooling	52
Multifunctional compact hydraulic module "Logico"	54
DN32 Pump units, equipments and zone manifolds	57
Thermostatic mixing and diverting valves	67
Zone valves	73
Rotary mixing valves	74
Underfloor heating control kit	77
Climatic controllers	83
Actuators and room thermostats	85
MODVSOL - SOLAR THERMAL	88
Solar pump units	92
Drain Back solar pump unit	98
Temperature sensors and cables	100
Differential solar controllers	101
Equipments and accessories	103
Technical section	108
Solar thermostatic mixing and diverting valves	113
Solar-boiler kit	115
Heat exchange solar unit	120
"Solo" pump units to load a buffer tank	122
CONTROL OF DOMESTIC HOT WATER (DHW)	128
Pump units to produce fresh domestic hot water (DHW)	129
ModvFresh "Kascata" system	141
DHW recirculation kit "DomvS Circ"	146
BIOMASS	148
Anti-condensation pump units DN20, DN25 and DN32	149
Anti-condensation valves	155
Anti-condensation recirculation pump unit "MCCS"	159
FLOWMETERS	164
STANDARD PRODUCTS	166
Ball valves	166
SigilBlock	169
TermoStar thermostatic radiator valves	170
CUSTOM MADE PRODUCTS	172
CIRCULATING PUMPS TECHNICAL DATA	174



8

HEATING AND COOLING



88

SOLAR THERMAL



128

CONTROL OF DHW



148

BIOMASS



164

FLOWMETERS



166

STANDARD PRODUCTS



172

CUSTOM MADE

The growing awareness of the problems relating to environmental protection and energy saving have pushed modern technology to seek more efficiency towards traditional heating systems and to evaluate new sources of renewable energy (solar thermal, biomass, geothermal, etc.).

From this point of view it is therefore foreseeable and desirable a diffusion of hybrid systems, in which a close integration between traditional and alternative installations, allows a significant energy saving.

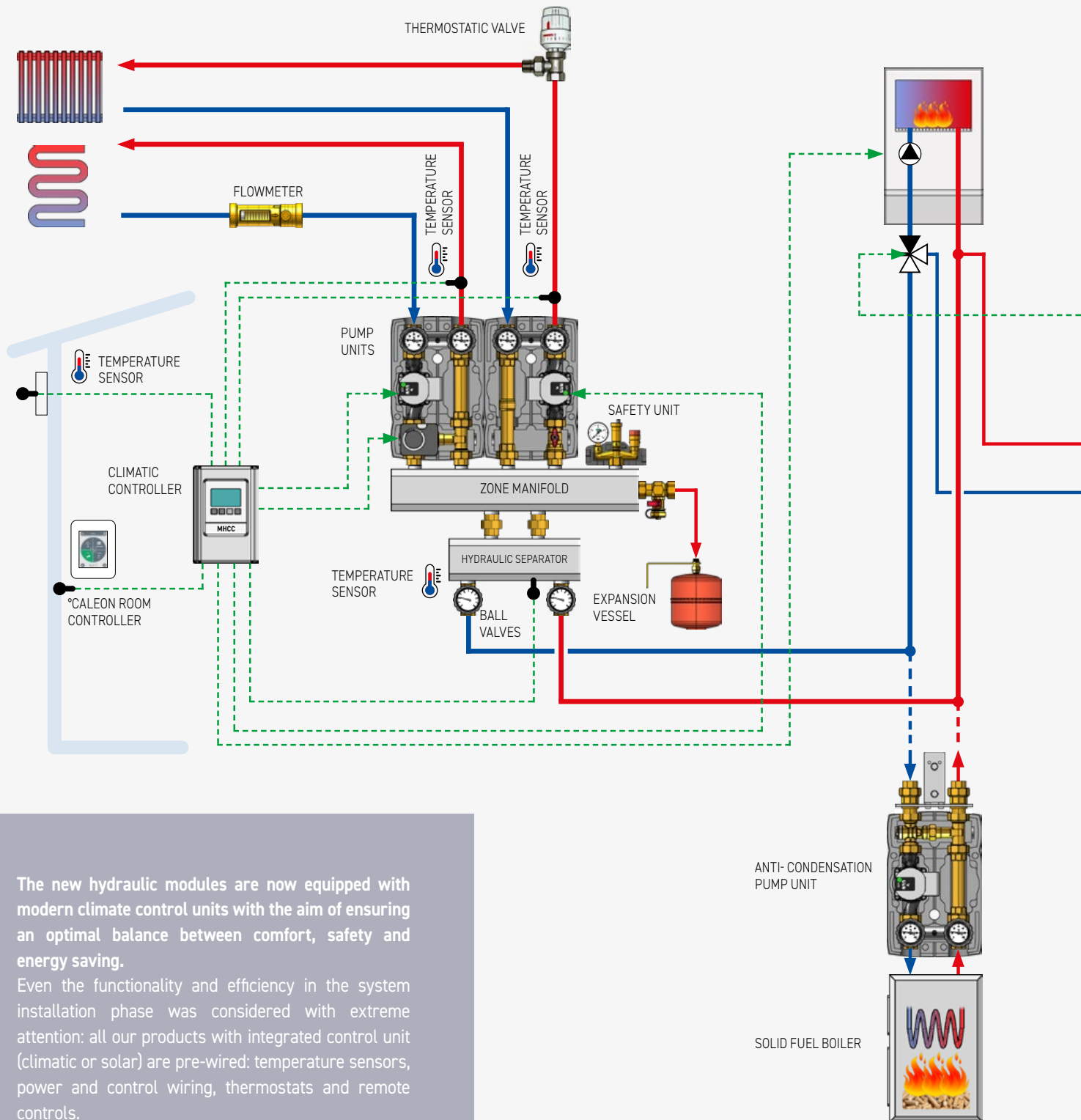

The new hydraulic modules are now equipped with modern climate control units with the aim of ensuring an optimal balance between comfort, safety and energy saving.

Even the functionality and efficiency in the system installation phase was considered with extreme attention: all our products with integrated control unit (climatic or solar) are pre-wired: temperature sensors, power and control wiring, thermostats and remote controls.

Plug and play!

The control system and integration of a solar system with other energy sources certainly concerns one of the most important and delicate aspects of the whole system. In fact, the expected behavior of the various components, the overall performance, the energy yield of the system and in some cases its integrity can be easily compromised by an inadequate or not perfectly efficient hydraulic and control system.

Thanks to the decades of experience of BRV in the production of solar components and the introduction of modern control units, which today are integrated into an elegantly designed insulation, **ModvSol** controls all the functions of your solar system in a simple

and intuitive way, whatever it is (1 or 2 batteries of collectors, 1 or more tanks, swimming pool, recirculation, etc.) guaranteeing the best possible heat output in complete safety.

Great attention was also dedicated to the prevention of legionnaire's disease. In fact, a requirement of solar thermal systems is that of having to accumulate the excess heat produced in the periods of greatest solar radiations and then use it later, when there is thermal demand. Today your buffer, tanks to **ModvFresh** will provide you with domestic hot water directly from the water supply.

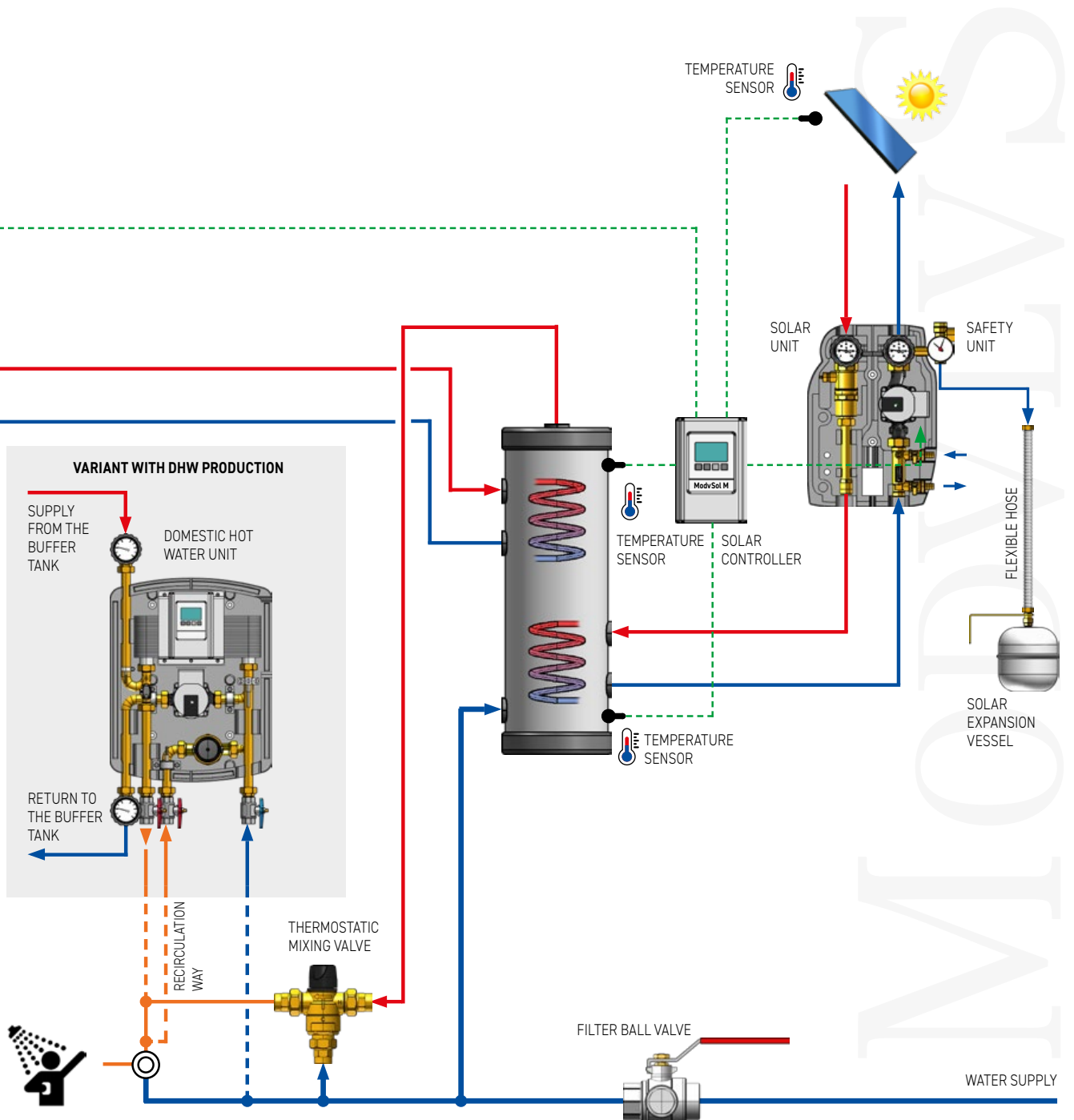

ModvBox

MODULAR MULTI-ZONE DISTRIBUTION BOX FOR WALL-MOUNTED GAS BOILERS AND HEAT PUMPS

Modular multi-zone distribution box for wall-mounted gas boilers and heat pumps. The extremely compact construction allows up to three circuits to be hydraulically connected in a total width of just 450 mm.

The primary circuit towards the gas boiler or heat pump includes, 2 shut-off valves 1" male and a zone manifold with integrated hydraulic separator, or a simple zone manifold, for powers up to 50 kW. The separator allows the primary circuit to be hydraulically disconnected from the secondary circuit and allows a greater volumetric circulation of the heat transfer fluid in use, with respect to what circulates in the gas boiler or heat pump. With gas boilers installations, the return temperature to the boiler is reduced, thus guaranteeing an increase in the efficiency of the installation. Air-vent valve and deaeration chamber. IP55 junction box to facilitate electrical wiring. The distribution box, white RAL 9010 powder coated, can be wall-mounted, recessed or placed inside a hanging cupboard.

Technical features

- Max flow rate in primary circuit up to 2 m³/h;
- Primary circuit connections: 1" male; centre distance 270 mm;
- Dimensions: (LxDxH) 450x160x550 mm;
- Internal insulation box in EPP (where provided);
- Max power: 50 kW – Max 6 bar;
- Head loss hydraulic separator: 0.2 mH₂O at the flow rate of 2000 l/h;
- Head loss zone manifold: 0.3 mH₂O at the flow rate of 1500 l/h for each circuit.

The modular system allows to choose between three types of pump units:

- **Unmixed**
- **Mixed motorized**
- **Mixed fixed point**

The pump units, with 70 mm centre distance and 3/4" female connection in use, can be connected to the zone manifold at will, by number and position among those available, thus creating a configuration that is always appropriate to the context. Each zone is supplied with a **Wilco Para 15-130/6 SC** circulating pump (other heads available on request). Each pump unit, in addition to the circulating pump, is equipped with a DN20 shut-off valve for both the supply and return, 0°C-120°C thermometer and check valve which can be excluded in case of system maintenance. Each valve has a sensor holder if the boiler electronics requires it.

Unmixed circuit

Nominal power of 35 kW (with $\Delta T=20$ K) at the flow rate of 1500 l/h (residual head 3.5 mH₂O)
Kvs value: 6.0

Centre distance 70 mm
PN 10, max temperature 95°C
3/4" female connections



Code:
402554-P6

Mixed motorized circuit

Nominal power of 30 kW (with $\Delta T=20$ K) at the flow rate of 1300 l/h (residual head 3.5 mH₂O)
Kvs value: 4.0

230V 3-point actuator, 10s;
proportional 0-10V on request.
Centre distance 70 mm
PN 10, max temperature 95°C
3/4" female connections



Code:
402554-M3-P6-TRM

Mixed fixed point circuit

Nominal power of 25 kW (with $\Delta T=20$ K) at the flow rate of 1100 l/h (residual head 3.5 mH₂O)
Kvs value: 3.0

Temperature adjustable from 20°C to 45°C;
other temperatures on request.
Centre distance 70 mm
PN 10, max temperature 95°C
3/4" female connections



Code:
402554-F3-P6

For systems with wall-mounted gas boiler or heat pump



With integrated hydraulic separator:

Code without insulation box: **402554-04M-HW**

Code with insulation box: **402554ISO-04M-HW**

With simple zone manifold:

Code without insulation box: **402554-04M-HV**

Code with insulation box: **402554ISO-04M-HV**



In photo, an example of configuration with pump units, unmixed, mixed motorized and mixed fixed point, with and without insulation box.

Today connections with boilers are no longer a problem in a central heating system

A full range of zone manifolds, pump units, actuators, circulating pumps and safety units allows a reliable connection with a considerable saving of time and money. The DN20 range is added to the two series DN25 and DN32; DN20 range is suitable to manage medium-low powers with a substantial space saving.

MODVLVS

Handy

It is assembled and ready to be connected to the pipes.

Fast

It can be connected in less than half an hour.

Reliable

It is provided with thermometers, flanged ball valves, check valve, by-pass valve, mixing valve, etc. It is suitable for the most of the circulating pumps on the market.

Multipurpose

The unit is reversible (right or left supply) and it is available in different configurations suitable for underfloor, radiators and solar heating systems.

Stylish

Modern and nice design.



In order to offer an even better service to customers, all our products are tested and checked at our factory. In the picture you can see some **Modvlvs** pilot plants that manage several kinds of systems: not only for heating of different powers, but also for solar and for the production of domestic hot water. The systems are used every day to check the functionality and are installed in a room where customers and visitors have access, accompanied by our staff who illustrate their operational features.



**Modular systems
for energy management
DN 20**

Heat source

- Wall gas boiler (without circulating pump).

Distribution

- Heating zone manifold **HV 60/90-2 DN20** for 2 pump units with safety unit, filling/draining valve and expansion vessel.

Heating users

- Low power radiator circuit, Δt 20 K: unmixed pump unit **M2 DN20** and differential by-pass valve.
- Low power underfloor heating circuit, Δt 8 K: mixed pump unit **M2 MIX3 DN20** and "T" connection with sensor holder.

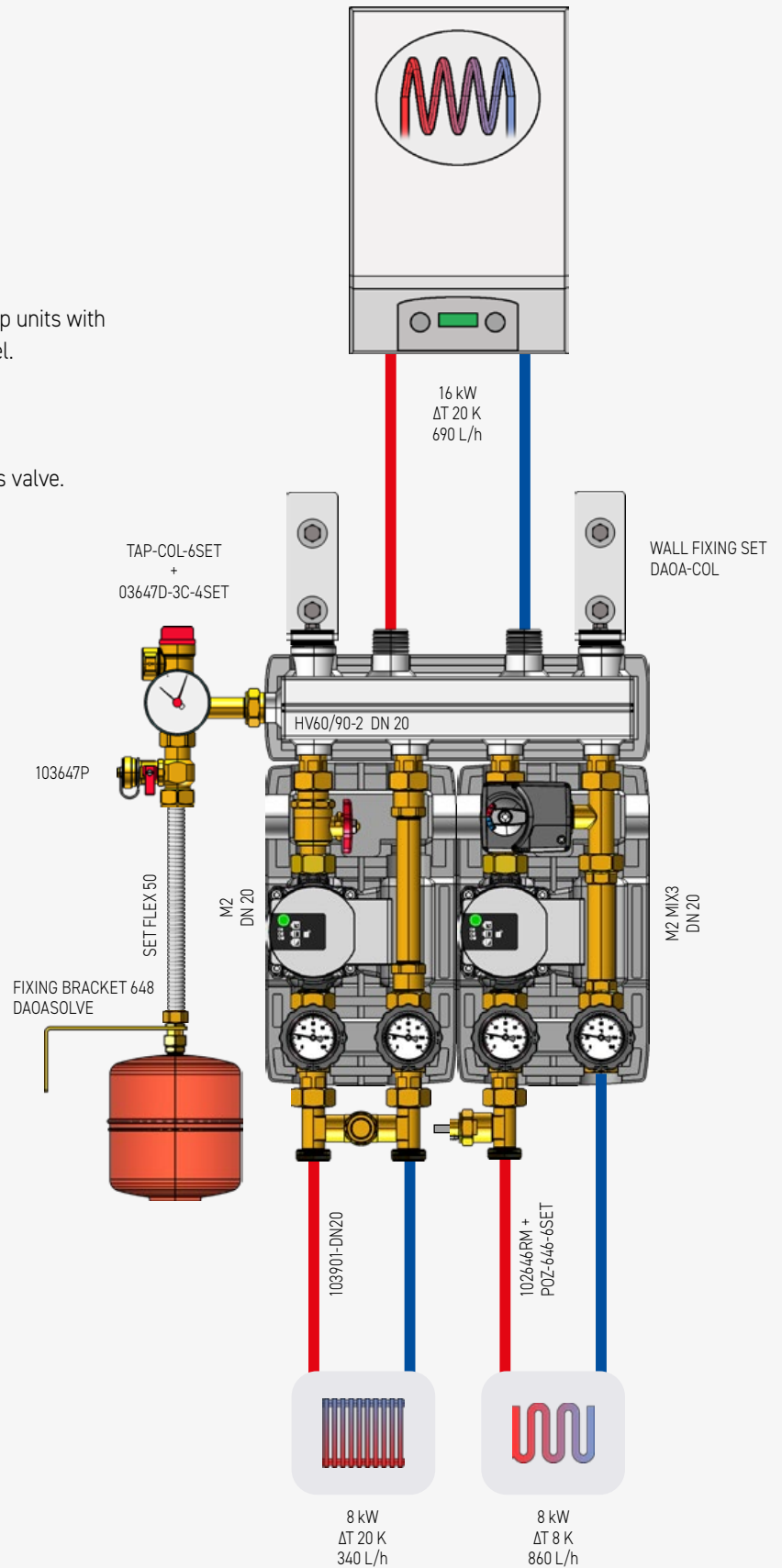
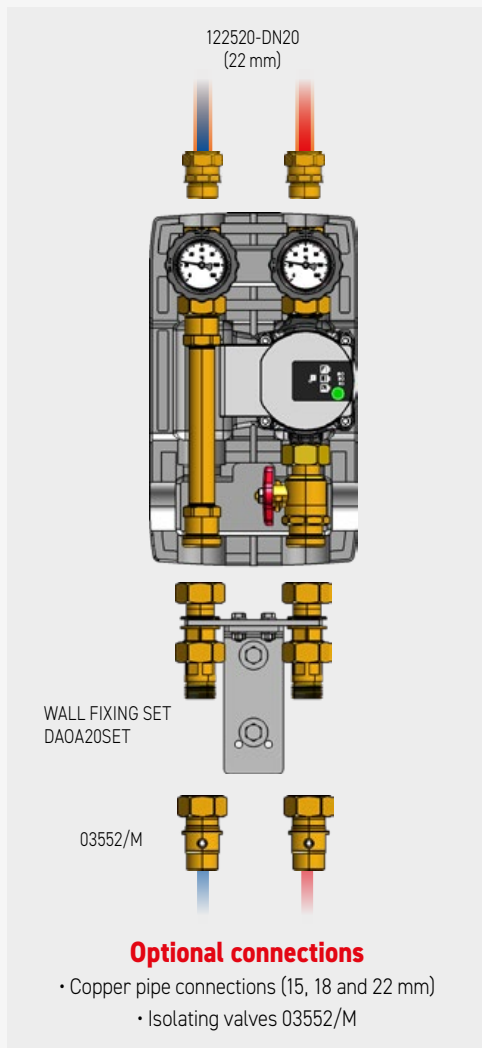

Note: the representations are to be considered just as an indication and they have no completeness pretension.

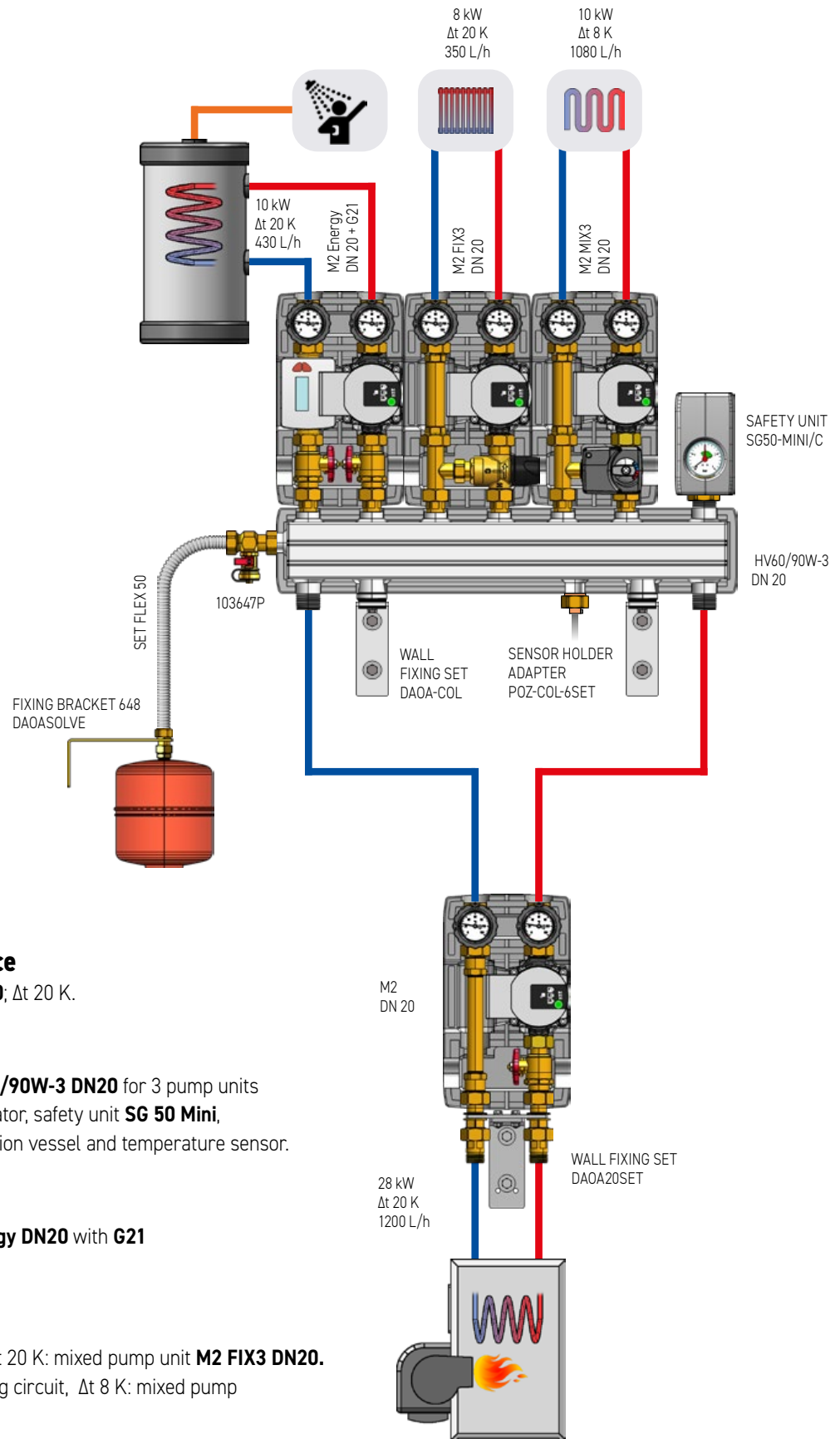

Heat source

- Gas boiler.

Supply from heat source

- Unmixed pump unit **M2 DN20**; Δt 20 K.

Distribution

- Heating zone manifold **HV 60/90W-3 DN20** for 3 pump units with built-in hydraulic separator, safety unit **SG 50 Mini**, filling/draining valve, expansion vessel and temperature sensor.

DHW tank loading

- Unmixed pump unit **M2 Energy DN20** with **G21** for heating metering; Δt 20 K.

Heating users

- Low power radiator circuit, Δt 20 K: mixed pump unit **M2 FIX3 DN20**.
- Low power underfloor heating circuit, Δt 8 K: mixed pump unit **M2 MIX3 DN20**.

Note: the representations are to be considered just as an indication and they have no completeness pretension.

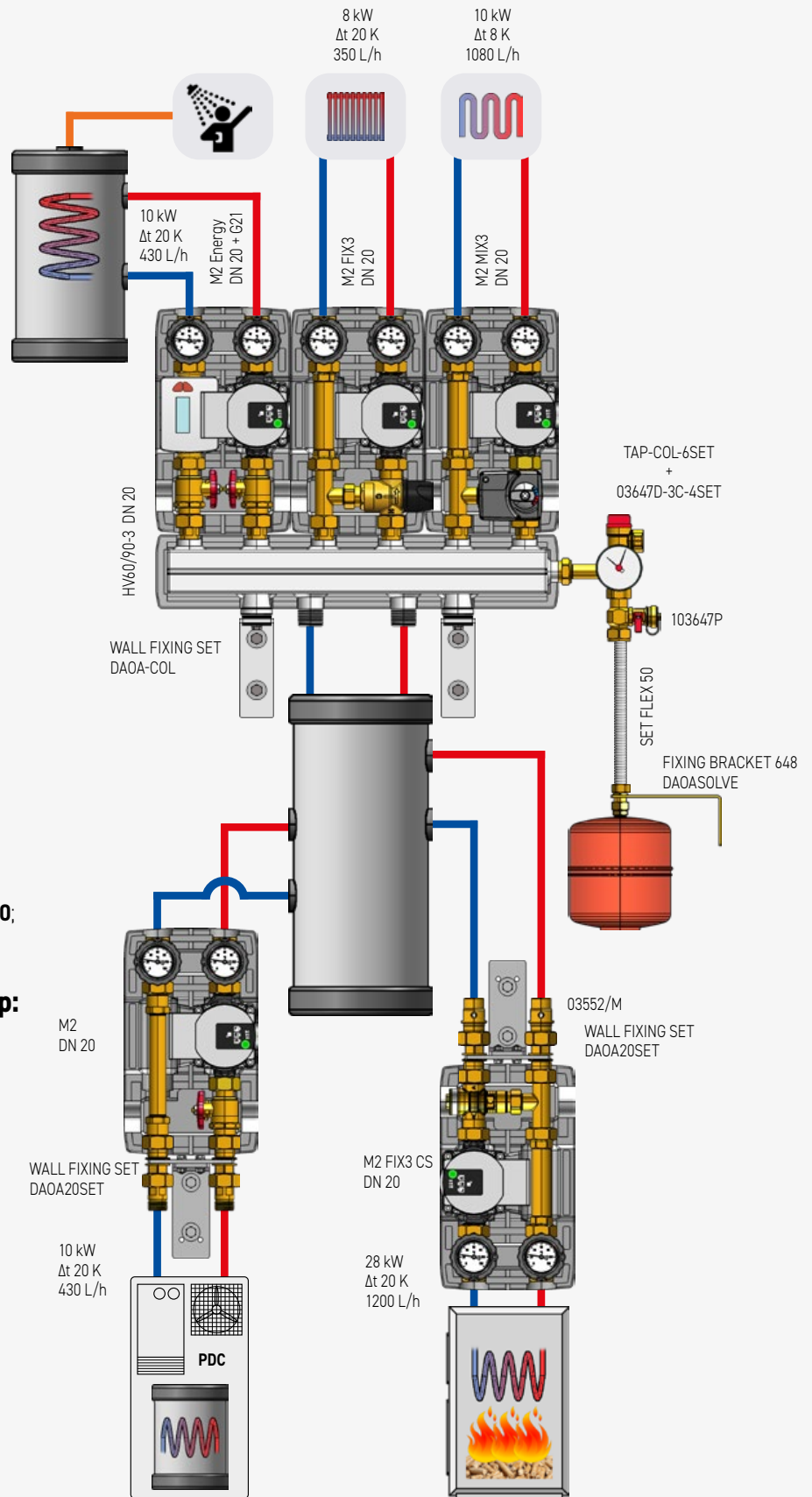

Heat source

- Solid fuel boiler and heat pump.

Buffer tank loading by the boiler

- Anti-condensation pump unit **M2 FIX3 CS DN20**; Δt 20 K.

Buffer tank loading by the heat pump:

- unmixed pump unit **M2 DN20**; Δt 20 K.

Distribution

- Heating zone manifold **HV 60/90-3 DN20** for 3 pump units, with safety unit, filling/draining valve and expansion vessel.

DHW tank loading

- Unmixed pump unit **M2 Energy DN20** with **G21** for heating metering; Δt 20 K.

Heating users

- Low power radiator circuit, Δt 20 K: mixed pump unit **M2 FIX3 DN20**.
- Low power underfloor heating circuit, Δt 8 K: mixed pump unit **M2 MIX3 DN20**.

Note: the representations are to be considered just as an indication and they have no completeness pretension.

ModvlvS DN20

Compact and up-to-date, the ModvlvS DN20 series offers functions similar to those of the bigger sizes DN25 and DN32. Especially suitable to manage medium-low powers in small rooms, thanks to its centre distance of only 90 mm. DN20 pump units can be connected to heating systems with powers up to 35kW, with a very low energy consumption ensured by high efficiency synchronous circulating pumps. The connections to the zone manifolds are made with 3/4" thread (male on manifold side and female on the heating circuit side). The range is supplemented by: zone manifolds, connections, safety units, mixing valves and actuators.

M2 2-WAY UNMIXED PUMP UNIT

The unit for 1/2" (130 mm) circulating pumps consists of:

Supply

- Connection.
- Flanged ball valve with T-handle.
- High efficiency synchronous pre-wired circulating pump (for the models that include it).
- Flanged ball valve supplied with in-handle thermometer (red ring, range 0°C-120°C).

Return

- Flanged ball valve with 20 mbar check valve (which can be excluded by rotating the handle by 45°) supplied with in-handle thermometer (blue ring, 0°C-120°C).
- Magnetic filter and ball valve (in the models where it is present)
- Connection.

Centre distance 90 mm. EPP insulation box (Dimensions: 180x302x142 mm). **PN 10, max temperature 110°C** (unit without pump).

Connections: 3/4" Male with swivel shank to the heat source or to the zone manifold. 3/4" Female to the user.

FIELD OF USE

For power up to 35 kW (with Δt 20 K) and maximum flow rate 1500 l/h.
Kvs Value: 6.0.

Approximate data calculated with a 6 m head circulating pump.
For an accurate sizing or for higher flow rates, please refer to the curve.

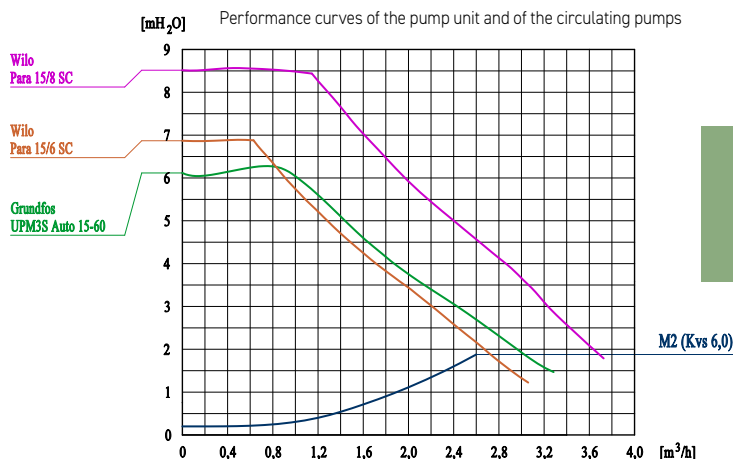

Code: **20255R**
With circulating pump: **20255R-(P6/A6/P8)**
With magnetic filter: Code: **202652**
With circulating pump: **202652-(P6/A6/P8)**



Available circulating pumps:
Wilo Para 15/6 SC (P6)
Grundfos UPM3S Auto 15-60 (A6)
Wilo Para 15/8 SC (P8)



Available model provided with magnetic filter



Available model provided with integrated magnetic filter



Standard version: right supply. Left supply version available with extra price: look at price list.

DN20 PUMP UNITS 3-WAY MIXED

M2 MIX3 2-WAY PUMP UNIT WITH 3-WAY MIXING VALVE

The unit for 1/2" (130 mm) circulating pumps consists of:

Supply

- Connection.
- 3-way mixing valve.
- High efficiency synchronous pre-wired circulating pump (for the models that include it).
- Flanged ball valve supplied with in-handle thermometer (red ring, range 0°C-120°C).

Return

- Flanged ball valve with 20 mbar check valve (which can be excluded by rotating the handle by 45°) supplied with in-handle thermometer (blue ring, 0°C-120°C).
- Magnetic filter (in the models where it is present)
- "T" Connection for mixing valve.
- Connection.

Centre distance 90 mm. EPP insulation box (Dimensions: 180x302x142 mm). **PN 10, max temperature 110°C** (unit without pump).

Connections: 3/4" Male with swivel shank to the heat source or to the zone manifold. 3/4" Female to the user.

FIELD OF USE

For power up to 28 kW (with Δt 20 K) and maximum flow rate 1200 l/h. Kvs Value: 4.0.

Approximate data calculated with a 6 m head circulating pump. For an accurate sizing or for higher flow rates, please refer to the curve.



It is recommended to install two isolating valves **Art. 552** (see the section "DN20 Zone manifolds") before the pump unit to allow an easy service or replacement of the components of the unit.

Code: **03552/M**

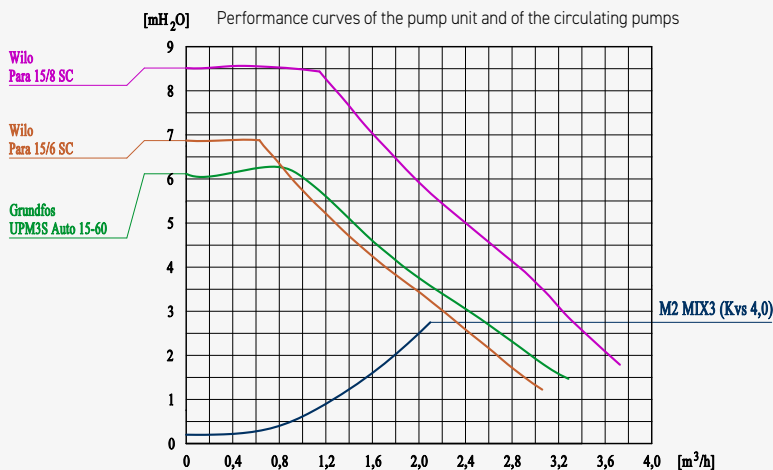

Standard version: right supply. Left supply version available with extra price: look at price list.



Code: **20255R-M3**

With circulating pump: **20255R-M3-(P6/A6/P8)**

With magnetic filter: Code: **202652-M3**

With circulating pump: **202652-M3-(P6/A6/P8)**



Available circulating pumps:

Wilo Para 15/6 SC (**P6**)

Grundfos UPM3S Auto 15-60 (**A6**)

Wilo Para 15/8 SC (**P8**)



Available model provided with magnetic filter



Model with built-in TRM20 actuator

Code 3/4": **20255R-M3-TRM**

With circulating pump: **20255R-M3-(P6/A6/P8)-TRM**

Actuator TRM20: 3 point actuator for mixing valve, bidirectional, reversible. Operating range of 90°, 230V, 105 s., torque 2 Nm. IP40.



Optional check valve for mixed pump units

DN 20 check valve to be installed into the body of the mixing valve on the return way. It prevents back flow rate of energy in presence of complex installations (e.g. different circulating pumps and/or several mixing valves on the zone manifold). Minimum opening pressure: 20 mbar. Kvs 7.2. Max Temperature: 95°C.

Code: **CRKZ20T0T**

M2 MIX33

2-WAY PUMP UNIT WITH 3-WAY MIXING VALVE WITH BUILT-IN BY-PASS

The unit for 1/2" (130 mm) circulating pumps consists of:

Supply

- Connection.
- 3-way mixing valve with adjustable by-pass. Through the by-pass (adjustable from the front part) it is possible to mix on the supply line a quantity of water coming back from the return line of the system.
- High efficiency synchronous pre-wired circulating pump (for the models that include it).
- Flanged ball valve supplied with in-handle thermometer (red ring, range 0°C-120°C).

Return

- Flanged ball valve with 20 mbar check valve (which can be excluded by rotating the handle by 45°) supplied with in-handle thermometer (blue ring; 0°C-120°C).
- Magnetic filter (in the models where it is present)
- "T" Connection for mixing valve.
- Connection.

Centre distance 90 mm. EPP insulation box (Dimensions: 180x302x142 mm).

PN 10, max temperature 110°C (unit without pump).

Connections: 3/4" Male with swivel shank to the heat source or to the zone manifold. 3/4" Female to the user.

FIELD OF USE

For power up to 33 kW (con Δt 15 K) and maximum flow rate 1900 l/h. Valore Kvs: 5.5.

For an accurate sizing or for higher flow rates, please refer to the curves shown in the next page.



Code: **20255R-M33**

With circulating pump: **20255R-M33-(P6/A6/P8)**

With magnetic filter: Code: **202652-M33**

With circulating pump: **202652-M33-(P6/A6/P8)**



Available circulating pumps:

Wilco Para 15/6 SC (P6)

Grundfos UPM3S Auto 15-60 (A6)

Wilco Para 15/8 SC (P8)



Available model provided with magnetic filter



It is recommended to install two isolating valves **Art. 552** (see the section "DN20 Zone manifolds") before the pump unit to allow an easy service or replacement of the components of the unit.

Code: **03552/M**

Integrated by-pass

The by-pass integrated into the 3-way mixing valve ensures a recirculation inside the installation, even when the mixing valve is fully open. Through the by-pass, a fixed percent of the mixing can be set, in the case when the flow through the mixing valve is not sufficient. In case of a bad working of the system causing an increase of the temperature of the installation, the recirculation through the by-pass allows a decrease of the water temperature in the underfloor installation, by mixing the warm water of the return circuit with the hot water of the supply circuit, reducing possible damages.

M2 MIX33 pump units are supplied with the recirculation by-pass fully open.

Approximate data for applications in low and medium temperature heating systems

Δt	Approximate power and flow rate of the application	Recommended circulating pump	Residual head	Approximate surface of the underfloor heating system
8 K	12 kW - 1300 l/h	Wilco Para 15/6 SC	4,5 mH ₂ O	Up to 100 m ²
8 K	17 kW - 1900 l/h	Wilco Para 15/8 SC	5 mH ₂ O	Up to 170 m ²
15 K	23 kW - 1300 l/h	Wilco Para 15/6 SC	4,5 mH ₂ O	-
15 K	33 kW - 1900 l/h	Wilco Para 15/8 SC	5 mH ₂ O	-

DN20 PUMP UNITS 3-WAY MIXED LOW TEMPERATURE

Operating principle

During normal operation, for example with the mixer completely closed on the recirculation, a part of the fluid is sucked by the pump all along the by-pass line. As a result, a very high user flow rate is obtained at a reduced temperature.

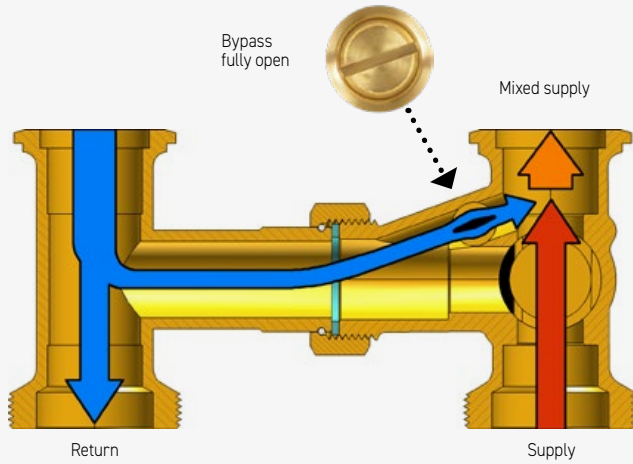

Adjusting the by-pass

The by-pass is **fully open** and it allows the maximum recirculation. The screwdriver cut is aligned along the reference indicator.

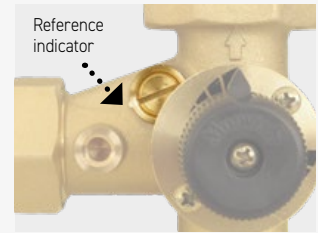

The by-pass is **fully closed** and there is no recirculation. The screwdriver cut is in an orthogonal position (at 90°) in comparison with the reference indicator.

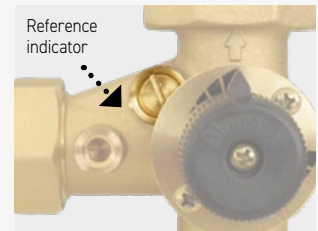

Model with built-in TRM20 actuator

Actuator TRM20: 3 point actuator for mixing valve, bidirectional, reversible. Operating range of 90°, 230V, 105 s., torque 2 Nm. IP40.

Code 3/4": **20255R-M33-TRM**

With circulating pump: **20255R-M33-(P6/A6/P8)TRM**



Optional check valve for mixed pump units

DN 20 check valve to be installed into the body of the mixing valve on the return way. It prevents back flow rate of energy in presence of complex installations (e.g. different circulating pumps and/or several mixing valves on the zone manifold).

Minimum opening pressure: 20 mbar.
Kvs 7.2. Max Temperature: 95°C.

Code: **CRKZ20TOT**

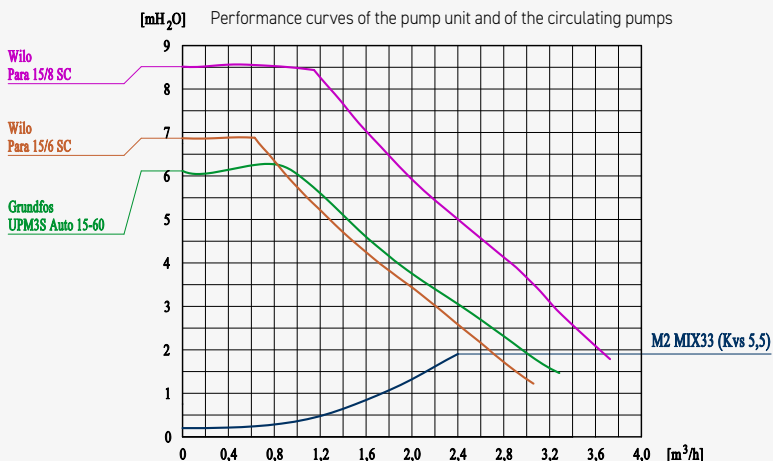

Standard version: right supply. Left supply version available with extra price: look at price list.



Code: **20255R-(F1/F2)**
With circulating pump: **20255R-(F1/F2)-(P6/A6/P8)**

M2 FIX3

2-WAY PUMP UNIT WITH FIXED TEMPERATURE THERMOSTATIC MIXING VALVE

The unit for 1/2" (130 mm) circulating pumps consists of:

Supply

- Connection.
- Adjustable thermostatic mixing valve, models F1 and F2.
- High efficiency synchronous pre-wired circulating pump (for the models that include it).
- Flanged ball valve supplied with in-handle thermometer (red ring, range 0°C-120°C).

Return

- Flanged ball valve with 20 mbar check valve (which can be excluded by rotating the handle by 45°) supplied with in-handle thermometer (blue ring; 0°C-120°C).
- "T" Connection for mixing valve.
- Connection.

Centre distance 90 mm. EPP insulation box (Dimensions: 180x302x142 mm).

PN 10, max temperature 110°C (unit without pump).

Connections: 3/4" Male with swivel shank to the heat source or to the zone manifold. 3/4" Female to the user.

FIELD OF USE

For power up to **22 kW (with Δt 20 K)** and maximum flow rate **1000 l/h.**
Kvs Value: 2.0.

For an accurate sizing or for higher flow rates, please refer to the curve.



Available circulating pumps:

- Wilo Para 15/6 SC (P6)
- Grundfos UPM3S Auto 15-60 (A6)
- Wilo Para 15/8 SC (P8)



Available thermostatic mixing valves:

- Setting range 20-45°C (F1)
- Setting range 45-70°C (F2)

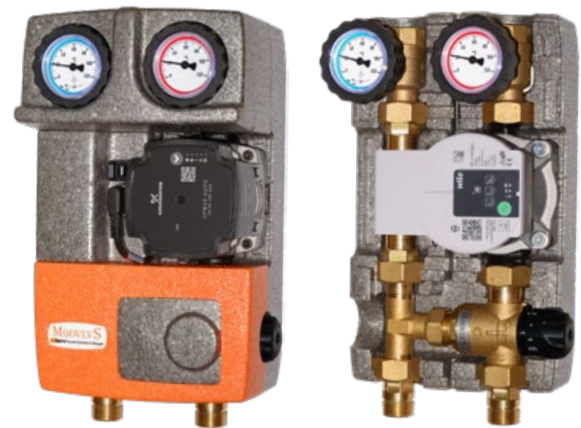

Approximate data for underfloor and radiator heating systems

Model	Setting range	Δt	Kvs	Approximate power and flow rate of the application	Recommended circulating pump	Residual head	Approximate surface of the underfloor heating system
F1	20-45°C	8 K	2,0	4,5 kW - 500 l/h	Wilo Para 15/6 SC	5 mH ₂ O	Up to 50 m ²
F2	45-70°C	20 K	2,0	11 kW - 500 l/h	Wilo Para 15/8 SC	5 mH ₂ O	-
F1	20-45°C	8 K	2,0	9 kW - 1000 l/h	Wilo Para 15/6 SC	4,5 mH ₂ O	50 m ² up to 100 m ²
F2	45-70°C	20 K	2,0	22 kW - 1000 l/h	Wilo Para 15/8 SC	5 mH ₂ O	-

Thanks to the **Multimix** thermostatic mixing valve the pump unit can deliver the maximum supply temperature, the same as the one of the inlet hot water. If lower temperatures are requested, to allow a regular and continuous mixing, it is necessary that the inlet hot water temperature is 3-5 K higher than the requested value of the outlet mixed temperature. Reference temperatures: **Model F1:** Th:55°C;Tv:24°C;Tmix:32°C **Model F2:** Th:75°C;Tv:40°C;Tmix:55°C



Note: The use in a cooling circuit inhibits thermostatic regulation, therefore for this application the functionality will be equivalent to that of an unmixed group

[mH₂O] Performance curves of the pump unit and of the circulating pumps

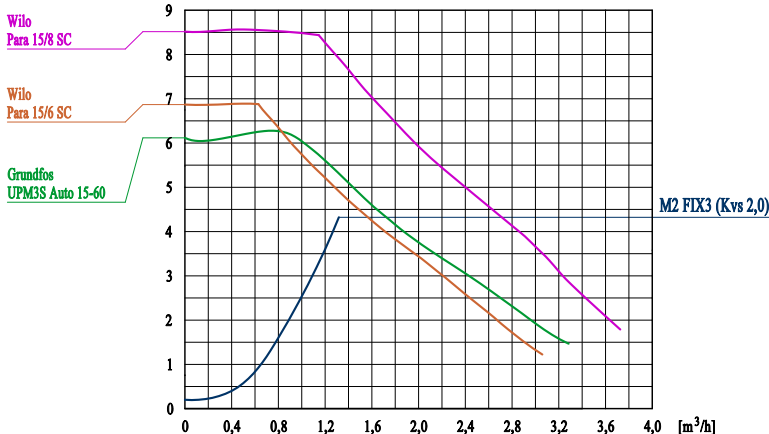

Standard version: right supply. Left supply version available with extra price: look at price list.



It is recommended to install two isolating valves **Art. 552** (see the section "DN20 Zone manifolds") before the pump unit to allow an easy service or replacement of the components of the unit.

Code: **03552/M**



Optional: safety bimetallic thermostat

Supplied in the group by adding "-T" (see section "Actuators and Room Thermostats")
Code example: **20255R-F1-P6-T**



Optional check valve for mixed pump units

Code: **CRKZ20TOT**

M2 Energy

2-WAY UNMIXED PUMP UNIT DESIGNED TO FIT A HEAT/COOLING ENERGY METER

The unit for 1/2" (130 mm) circulating pumps consists of:

Supply

- Connection.
- Flanged ball valve with T-handle.
- High efficiency synchronous pre-wired circulating pump (for the models that include it).
- 3-way flanged ball valve supplied with in-hand thermometer (redring, range 0°C-120°C). The third way M10x1 allows the dip fitting and the lead sealing of a $\varnothing 5 \times 45$ mm sensor.

Return

- Flanged ball valve with 20 mbar check valve (which can be excluded by rotating the handle by 45°) supplied with in-handle thermometer (blue ring; 0°C-120°C).
- Distance piece made of plastic 1"x130mm that has to be removed, after having cleaned the installation, to fit the heat/cooling energy meter.
- Flanged ball valve with T-handle.
- Connection.

Centre distance 90 mm. EPP insulation box (Dimensions: 180x302x142 mm).

PN 10, max temperature 90°C.

Connections: 3/4" Male with swivel shank to the heat source or to the zone manifold. 3/4" Female to the user.

FIELD OF USE

For power up to 35 kW (with Δt 20 K) and maximum flow rate 1500 l/h (*). Kvs value: 6,0 (*).

Approximate data calculated with a 6 m head circulating pump.

For an accurate sizing or for higher flow rates, please refer to the curve.

(*) The data are relevant to the pump unit without heat/cooling energy meter installed.



Code: **202518-20**

With circulating pump: **202518-(P6/A6/P8)-20**



Available circulating pumps:

- Wilo Para 15/6 SC (P6)
- Grundfos UPM3S Auto 15-60 (A6)
- Wilo Para 15/8 SC (P8)



Installable heat/cooling energy meters:
DN20 - 1" x 130
Qn 2,5 (20)

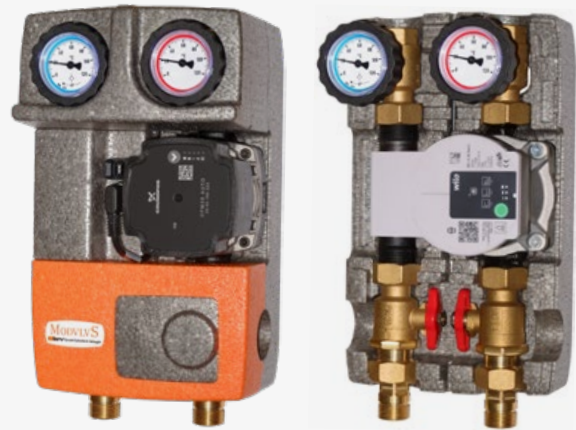

Supply isolating valve

with built-in pit for the insertion and the lead sealing of the hot water sensor.



[mH₂O] Performance curves of the pump unit and of the circulating pumps

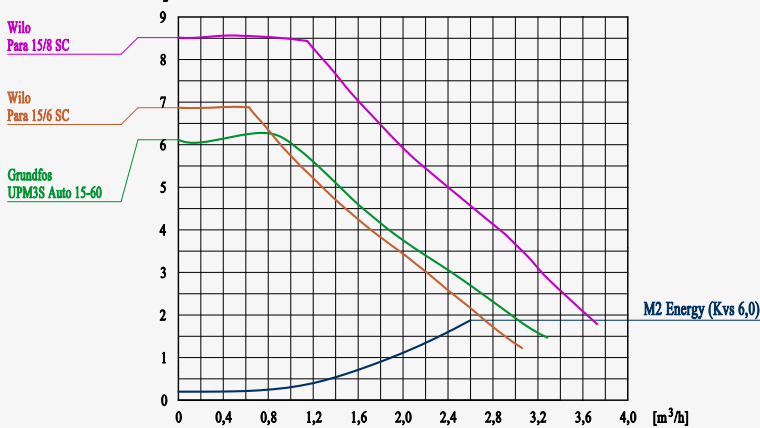

Approximate data of the Energy pump unit with the heat/cooling energy meter installed

Model	Energy meter	Δt	Kvs of the unit	Approximate power and flow rate of the application	Recommended circulating pump	Residual head
M2 + G21	2,5 m ³ /h	20 K	3,8	23 kw - 1000 l/h	Wilo Para 15/6 SC	5 mH ₂ O
M2 + G21	2,5 m ³ /h	20 K	3,8	39 kw - 1700 l/h	Wilo Para 15/8 SC	5 mH ₂ O

(*) The indicated Kvs concerns the unit including the heat/cooling energy meter installed

M2 MIX3 Energy

2-WAY PUMP UNIT WITH 3-WAY MIXING VALVE
DESIGNED TO FIT A HEAT/COOLING ENERGY METER

The unit for 1/2" (130 mm) circulating pumps consists of:

Supply

- Connection.
- 3-way mixing valve.
- High efficiency synchronous pre-wired circulating pump (for the models that include it).
- 3-way flanged ball valve supplied with in-hand thermometer (redring, range 0°C-120°C). The third way M10x1 allows the dip fitting and the lead sealing of a $\phi 5 \times 45$ mm sensor.

Return

- Flanged ball valve with 20 mbar check valve (which can be excluded by rotating the handle by 45°) supplied with in-handle thermometer (blue ring; 0°C-120°C).
- Distance piece made of plastic 1"x130mm that has to be removed, after having cleaned the installation, to fit the heat/cooling energy meter.
- T-connection for mixing valve.
- Connection.

Centre distance 90 mm. EPP insulation box (Dimensions: 180x302x142 mm).

PN 10, max temperature 90°C.

Connections: 3/4" Male with swivel shank to the heat source or to the zone manifold. 3/4" Female to the user.

FIELD OF USE

For power up to 28 kW (with Δt 20 K) and maximum flow rate 1200 l/h (*).
Kvs value: 4.0 (*).

Approximate data calculated with a 6 m head circulating pump.

For an accurate sizing or for higher flow rates, please refer to the curve.

(*) The data are relevant to the pump unit without heat/cooling energy meter installed.

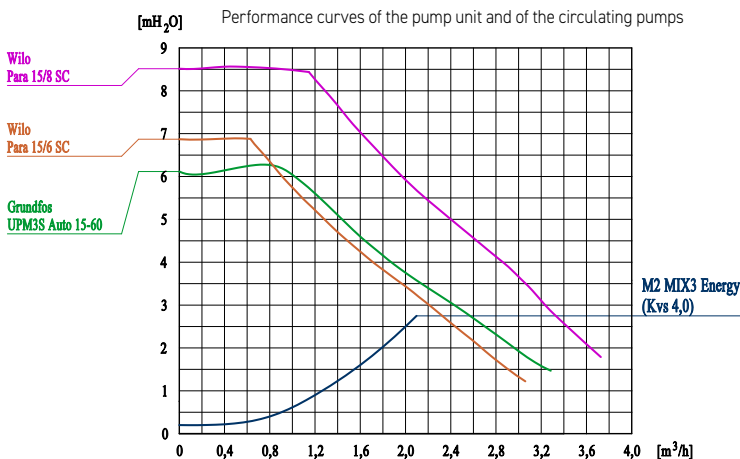

Approximate data of the Energy pump unit with the heat/cooling energy meter installed

Model	Energy meter	Δt	Kvs of the unit	Approximate power and flow rate of the application	Recommended circulating pump	Residual head
M2 MIX3 + G21	2,5 m ³ /h	20 K	3,1	21 kw - 900 l/h	Wilo Para 15/6 SC	5 mH ₂ O
M2 MIX3 + G21	2,5 m ³ /h	20 K	3,1	35 kw - 1500 l/h	Wilo Para 15/8 SC	5 mH ₂ O

(*) The indicated Kvs concerns the unit including the heat/cooling energy meter installed



Code: **202518-M3-20**

With circulating pump: **202518-M3-(P6/A6/P8)-20**



Available circulating pumps:

- Wilo Para 15/6 SC (P6)
- Grundfos UPM3S Auto 15-60 (A6)
- Wilo Para 15/8 SC (P8)



Installable heat/cooling energy meters:
DN20 - 1" x 130
Qn 2,5 (20)

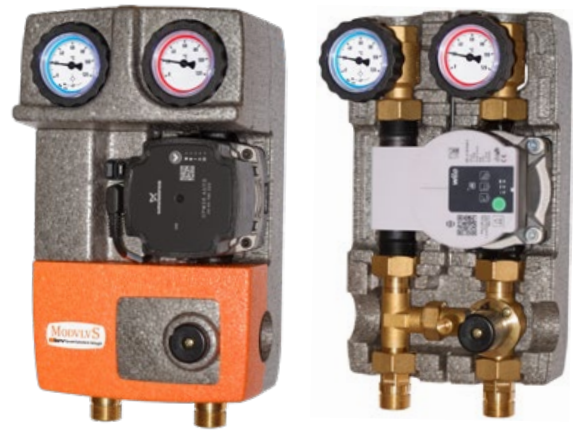

Supply isolating valve

with built-in pit for the insertion and the lead sealing of the hot water sensor.



It is recommended to install two isolating valves **Art. 552** (see the section "DN20 Zone manifolds") before the pump unit to allow an easy service or replacement of the components of the unit.

Code: **03552/M**

Optional check valve for mixed pump units

DN 20 check valve to be installed into the body of the mixing valve on the return way. It prevents back flow rate of energy in presence of complex installations (e.g. different circulating pumps and/or several mixing valves on the zone manifold).

Minimum opening pressure: 20 mbar.

Kvs 7.2. Max Temperature: 95°C.

Code: **CRKZ20TOT**



M2 FIX3 Energy

2-WAY PUMP UNIT WITH FIXED TEMPERATURE THERMOSTATIC MIXING VALVE DESIGNED TO FIT A HEAT/COOLING ENERGY METER

The unit for 1/2" (130 mm) circulating pumps consists of:

Supply

- Connection.
- Adjustable thermostatic mixing valve, models F1 and F2.
- High efficiency synchronous pre-wired circulating pump (for the models that include it).
- 3-way flanged ball valve supplied with in-handle thermometer (red ring, range 0°C-120°C). The third way M10x1 allows the dip fitting and the lead sealing of a $\varnothing 5 \times 45$ mm sensor.

Return

- Flanged ball valve with 20 mbar check valve (which can be excluded by rotating the handle by 45°) supplied with in-handle thermometer (blue ring; 0°C-120°C).
- 1"x130 mm distance piece made of plastic that has to be removed, after having cleaned the installation, to fit the heat/cooling energy meter.
- T-connection for mixing valve.
- Connection.

Centre distance 90 mm. EPP insulation box (Dimensions: 180x302x142 mm). **PN 10, max temperature 90°C.**

Connections: 3/4" Male with swivel shank to the heat source or to the zone manifold. 3/4" Female to the user.

FIELD OF USE

**For power up to 22 kW (with Δt 20 K) and maximum flow rate 1000 l/h (*).
Kvs value: 2.0 (*).**

Approximate data calculated with a 6 m head circulating pump.
For an accurate sizing or for higher flow rates, please refer to the curve.
(* The data are relevant to the pump unit without heat/cooling energy meter installed.

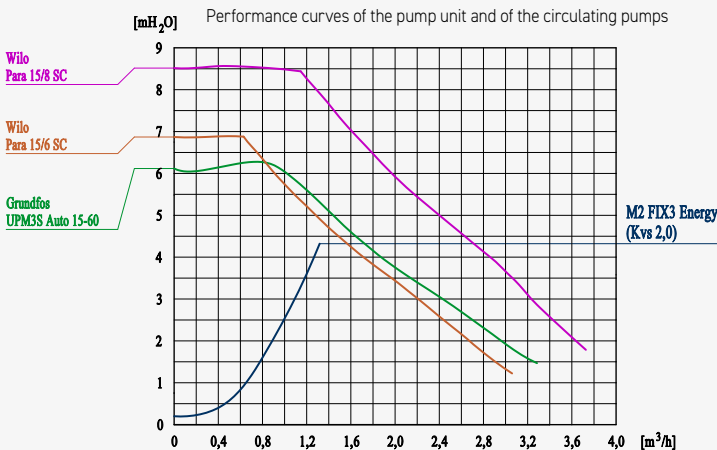

Code: **202518-(F1/F2)-20**

With circulating pump: **202518-(F1/F2)-(P6/A6/P8)-20**



Available circulating pumps:

- Wilo Para 15/6 SC (P6)
- Grundfos UPM3S Auto 15-60 (A6)
- Wilo Para 15/8 SC (P8)



Installable heat/cooling energy meters:
DN20 - 1" x 130
Qn 2,5 (20)



Available thermostatic mixing valves:

- Setting range 20-45°C (F1)
- Setting range 45-70°C (F2)



Supply isolating valve

with built-in pit for the insertion and the lead sealing of the hot water sensor.



It is recommended to install two isolating valves Art. **552** (see the section "DN20 Zone manifolds") before the pump unit to allow an easy service or replacement of the components of the unit.

Code: **03552/M**



Optional check valve for mixed pump units

DN 20 check valve to be installed into the body of the mixing valve on the return way. It prevents back flow rate of energy in presence of complex installations (e.g. different circulating pumps and/or several mixing valves on the zone manifold). Minimum opening pressure: 20 mbar. Kvs 7.2. Max Temperature: 95°C.

Code: **CRKZ20T0T**

Approximate data of the Energy pump unit with the heat/cooling energy meter installed

Model	Setting range	Energy meter	Δt	Kvs of the unit	Approximate power and flow rate of the application	Recommended circulating pump	Residual head
M2 FIX3 F1 + G21	20-45°C	2,5 m³/h	8 K	1,9	9 kw - 1000 l/h	Wilo Para 15/8 SC	5 mH ₂ O
M2 FIX3 F2 + G21	45-70°C	2,5 m³/h	20 K	1,9	23 kw - 1000 l/h	Wilo Para 15/8 SC	5 mH ₂ O

(* The indicated Kvs concerns the unit including the heat/cooling energy meter installed

Art. 901
DIFFERENTIAL VALVE
(BYPASS)



Differential by-pass valve to balance the pressure of the heating system, with connections to mount it directly on DN20 pump units. Yellow brass finish. Setting range: 0-0.5 bar.

Centre distance 90 mm.

PN 10. Max temperature 110°C.

Kvs value: 5.0.

Size: 3/4" Male union connection x 1" Male

Code: **103901-DN20**

Set 646R
CONNECTION SET
FOR EQUIPMENTS



"T" connection for DN20 pump units. The set allows the side mounting of several equipments such as, for instance, sensor holder pit, safety units, filling/draining valves. The set consists of "T" connection, EPDM gasket and Male union connection. Made of brass CW617N. Yellow brass finish.

Size: 3/4" Male union connection x 1" Male.

Code: **102646RM**

Wall fixing set
DN20



Thanks to the wall fixing set and to the bracket plate it is possible to hold the pump unit at a distance of 100 or 150 mm (between the wall and the axis of pipes).

Insertion dimension: 48 mm.

Centre distance 90 mm.

Threaded connections 1" Male x 1" swivel nut.

Code: **DA0A20SET**

Safety unit



Safety unit provided with a 3 bar safety valve CE certified according to Directive 97/23/CE and TÜV. Pressure gauge ø 50 mm 0-4 bar. 3/4" Male connection for the flexible pipe or the draining kit (103647P).

End of drain side: 3/4" F. The connection to the connector is allowed by means of a special seal kit with precharged EPDM OR that does not need any seal paste, hemp or other sealants.

50 kW safety valve.

PN 10. Max Temperature 110°C.

Code: **03647D-3C-4SET**

3/4" Male adapter
FOR COPPER PIPES



The kit consists of 3/4" Male compression union, nut and olive. It allows the connection of 3/4" Female pump units to copper pipes, diameter 15, 18 and 22 mm. Yellow brass finish.

Code 3/4" Male x 15 mm: **115520-DN20**

Code 3/4" Male x 18 mm: **118520-DN20**

Code 3/4" Male x 22 mm: **122520-DN20**

Filling/draining valve



Ball valve suitable to fill/drain the installation. The connection to the connector is allowed by means of a special seal kit with precharged EPDM O-ring that does not need any seal paste, hemp or other sealants.

End of drain side 3/4" Male.

PN 10. Constant temperature 120°C (short time temperature: 160°C for 20 s).

Code: **01646R-430SCASET**

1/2" Adapter
WITH SENSOR HOLDER PIT



Adapter with sensor holder pit $\varnothing 6$ mm. Equipped with a M4 screw to fix the temperature sensor. Thanks to the 1/2" adapter to be sealed to the zone manifold or to the hydraulic separator, the seal is allowed by a special sealing system with precharged EPDM O-Ring, that does not need any seal paste, hemp or other sealants.

PN10. Constant temperature 120°C.

Code: **POZ-COL-6SET**

Set nut 1"
AND EPDM GASKET



Yellow brass finish.

Code: **AYHT04SET**

Set nut 1",
EPDM GASKET
AND MALE ADAPTER 3/4"



Yellow brass finish.

Code: **103629F**

Optional check valve
FOR MIXED PUMP UNITS



DN 20 check valve to be installed into the body of the mixing valve on the return way. It prevents back flow rate of energy in presence of complex installations (e.g. different circulating pumps and/or several mixing valves on the zone manifold).

Minimum opening pressure: 20 mbar. Kvs 7.2. Max Temperature: 95°C.

Code: **CRKZ20TOT**

BRC thermostat



CE

Bimetallic unipolar thermostat with contact on interruption or on switching. The fastening of thermostat is made by means of a spring clamp for a constant sealing which guarantees a very good adherence to the pipes. ENEC approval.

Setting range: 20+90°C

Differential: 8 ± 3 K (regolabile)

Power on contacts: 16 (2.5) A / 250 V AC

Protection IP20.

Code: **BRC**

Actuator TRM20

CE



3 point actuator for mixing valve. Bidirectional, reversible.

Operating range of 90°, 105 s., torque 2 Nm.

Power supply 230V. IP40.

Code: **TRM20**

Proportional actuator TRM50

CE



Proportional actuator for mixing valve. Control signal 0-10V. Bidirectional, reversible. Operating range of 90°. 90 s., torque: 2 Nm.

Power supply AC/DC 24V. IP40.

Code: **TRM50**

Art. 652
MAGNETIC FILTER

Function

The magnetic filter is a device that allows to collect sludge and ferrous particles in hydraulic circuits, residues that can compromise the operation of many components such as boilers, synchronous circulating pumps, heat and magnetic meters, etc.

Its particular internal conformation, developed by BRV in its laboratories, exploits some simple principles of physics that allow to create, by pressure difference, an area of calm in the fluid vein where sludge and ferrous particles are deposited, since attracted by a powerful neodymium magnet. These can then be removed easily from the system by acting on the drain valve, an operation that we suggest to repeat at each plant start-up especially in the old ones that are more subject to corrosion and therefore where the concentration of sludge and ferrous particles is higher.

Features

- Compact dimensions combined with very low head losses
- No maintenance or cleaning of the device is required, if not periodic discharge of sludge collected through the drain valve
- Neodymium magnet with attraction force of 4.5 kg and magnet strength 13.000 Gauss
- Simple installation in heating pump units or directly in-line in the circuit (vertical assembly)
- Flow rate up to 2,500 l/h
- Compatible with anti-freeze fluids (glycol ≤ 50%)

PN 10. Maximum temperature 110°C
External connections and Kvs available:
DN20: 1" x 130 mm - Kvs 15

Possibility of installation in heating pump units



Code 1" Kvs 15: **104652-15**



Conversion Kit
FOR UNMIXED MODULES

Conversion kit for the installation of the magnetic filter in unmixed modules. It consists of magnetic filter, set nut and gasket, ball valve. The kit must be installed on the return way of the unmixed unit, as shown in the image.



Code: **104652-15-SET**

Installation
IN MIXED PUMP UNITS

To install the magnetic filter in mixed units, simply replace the straight fitting of the return.



Unmixed and mixed pump units
WITH PREINSTALLED MAGNETIC FILTER

Available model provided with magnetic filter, for unmixed modules (M2) and units with 3-way mixing valve (M2 MIX3/ MIX33).
In the product code replace "55R" with "652".
Example: 20255R-M3 will become 202652-M3.

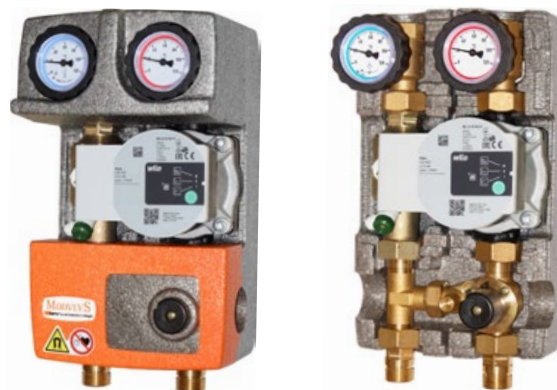

DN20 Zone manifolds for heating systems made of electro-welded iron pipe, with a special zinc-flake coating anticorrosion treatment, suitable for power up to 50 kW.

EPP thermic insulation. Hydraulic test at 12 bar. ModvlvS connection centre distance: 90 mm. The range of the zone manifolds is suitable for DN20 3/4" ModvlvS pump units.



Combi zone manifold HV 60/90W
(2 m³/h - 50 kW)

Zone manifold with insulation and built-in hydraulic separator for power up to 50 kW (rise in temperature $\Delta T=20$ K in the primary circuit). Deaeration chamber with 1" flat sealing male connection for safety unit SG50-Mini/C. Connections 1/2" Female for equipments.

Maximum flow rate up to 2 m³/h - Max. 6 bar
Insulation box section dimensions: 120 x 100 mm.

Connections to the pump units:
3/4" Female, centre distance 90 mm (pitch 180 mm).

Connections to the boiler:
1" Male; centre distance 380 mm (HV60/90W-2) or 560 mm (HV60/90W-3).

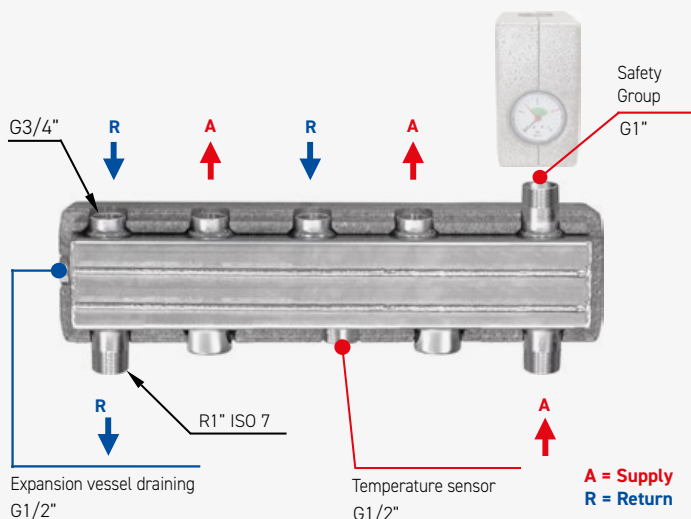

Model	Use	Lenght	Code
HV 60/90W-2	For connecting 2 DN20 units	470 mm	HV60/90W-2
HV 60/90W-3	For connecting 3 DN20 units	650 mm	HV60/90W-3

Safety Unit SG 50 Mini

Safety unit for closed circuit heating systems as per EN 12828 regulations with power up to 50 kW. Brass body, pre-assembled end tested, equipped with selfseal valves to allow an easy replacement of the pressure gauge and of the air-vent valve. It consists of:

- Pressure gauge $\varnothing 50$, 0-4 bar, 1/4"
- 3/8" automatic air-vent valve. Nominal pressure: 12 bar
- Safety valve 3 bar 50 kW. Inlet 1/2", outlet 3/4".
- EPP insulation box (Dimensions: 150x140x82 mm).

Max Temperature 120°C
Size: 1" Female

Code 1" swivel nut: **SG50-MINI/C**
Code 1" F: **SG50-MINI**



Zone manifold HV 60/90

(2 m³/h - 50 kW)

Zone manifold with insulation suitable for power up to 50 kW (rise in temperature $\Delta T=20$ K in the primary circuit). 1/2" Female side connection for equipments.

Maximum flow rate up to 2 m³/h - Max. 6 bar.
Insulation box section dimensions: 100 x 100 mm.

Connections to the pump units:
3/4" Female, centre distance 90 mm (pitch 180 mm).

Connection to the hydraulic separator code HW60/125-04 with threaded end 1" Male (centre distance 125 mm); for the connection use n. 2 sets code 04629SET (1").

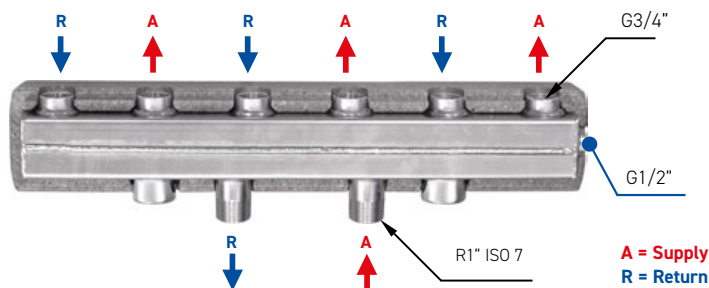

Model	Use	Lenght	Code
HV 60/90-2	For connecting 2 DN20 units	360 mm	HV60/90-2
HV 60/90-3	For connecting 3 DN20 units	540 mm	HV60/90-3

Wall fixing set for DN20 zone manifolds

Pair of brackets to fix to the wall the zone manifold with the insulation box 100 x 100 mm. Distance between the wall and the centre of the zone manifold can be 100 or 150 mm.

Code: **DA0A-COL**



1/2" adapter with plug for equipments

1/2" adapter to be sealed to the zone manifold, to connect the different equipments (safety unit with expansion vessel, filling/draining valve, etc.).

Code: **TAP-COL-6SET**



Art. 552

Isolating ball valve 3/4" Male for 1" swivel nut. Yellow brass finish. Gasket not included. Ends threaded to ISO 228 (DIN 259 BSP 2779). Operating stem with allen screw or allen spanner.
PN 6. Max temperature 110°C. DN15.

Code: **03552/M**



Three piece set for connecting the hydraulic separator to the zone manifold

EPDM gasket. Yellow brass finish. To connect the hydraulic separator to the zone manifold two sets are necessary.
Sizes: 1" F x 1" F

Code 1": **04629SET**



**Modular systems for energy management
DN 25**

Heat source

- Gas boiler.

Supply from heat source

- Unmixed pump unit **M2 DN25**; Δt 20 K.

Distribution

- Hydraulic separator **HW 60/125-04 DN25**;
- Heating zone manifold **HV 60/125-SG2 DN25** for 2 pump units with safety unit **SG 50** and expansion vessel.

Heating users

- Medium power radiator circuit, Δt 20 K: unmixed pump unit **M2 DN25**;
- High power radiator circuit, Δt 20 K: mixed pump unit **M2 MIX3 DN25**.

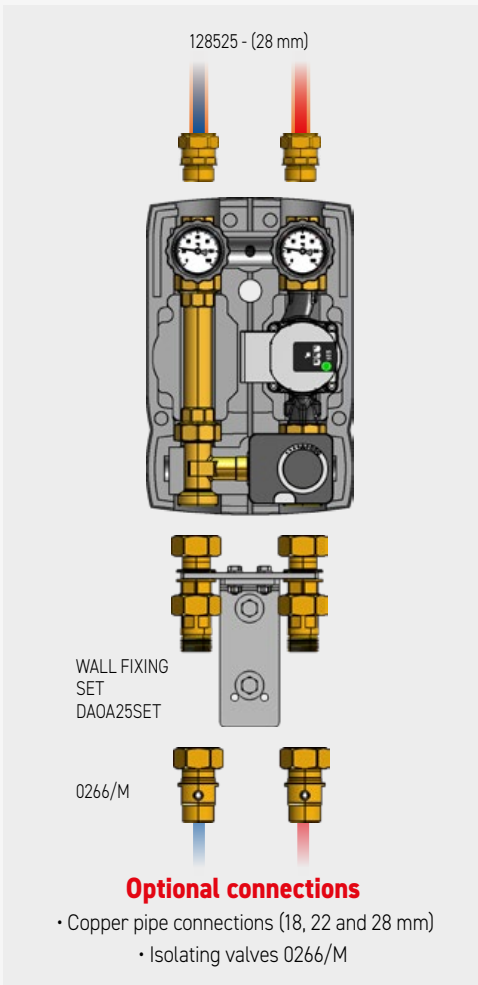
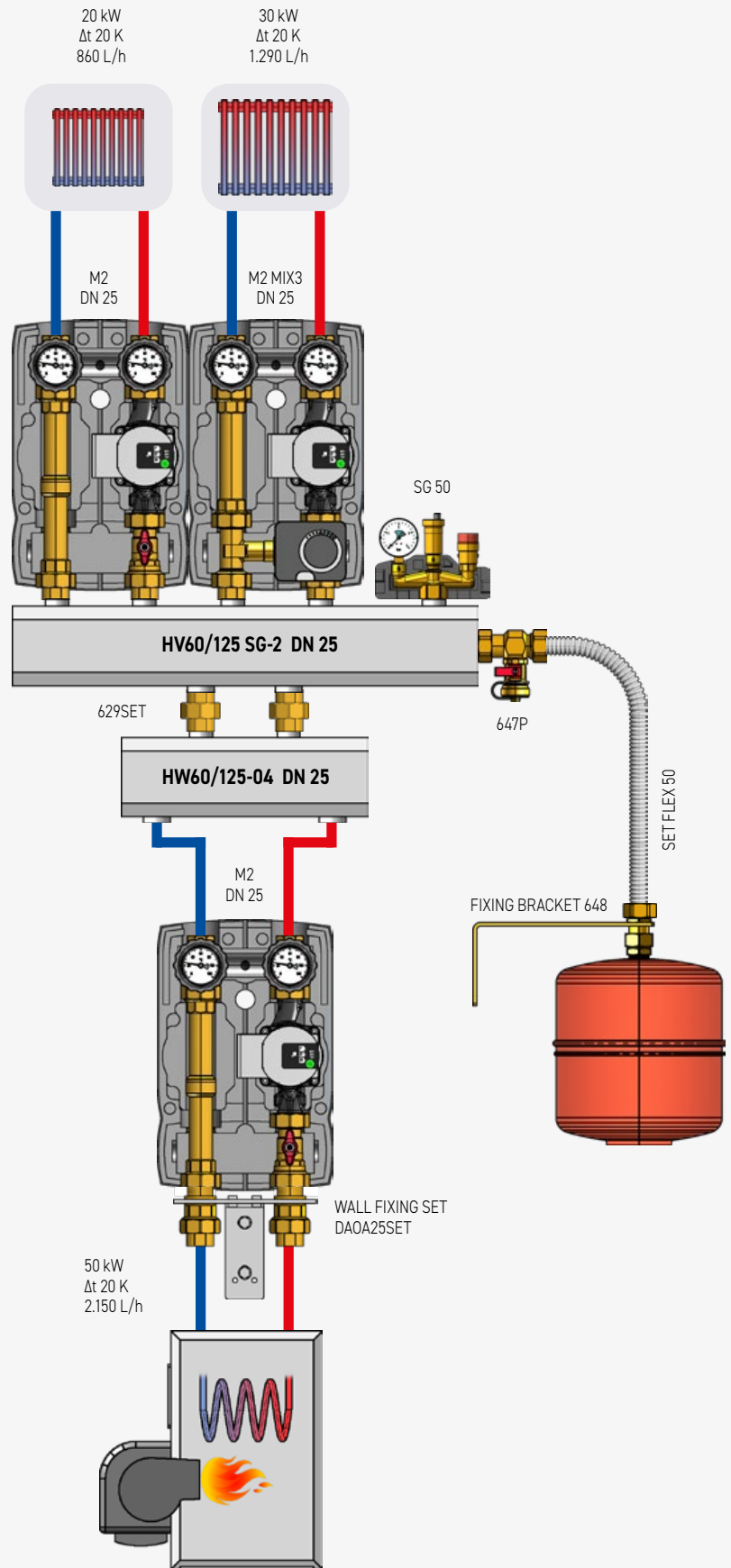

Note: the representations are to be considered just as an indication and they have no completeness pretension.

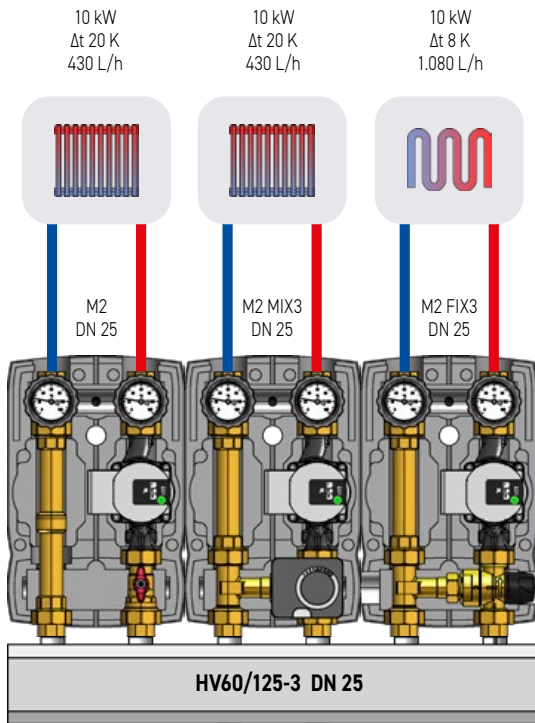

Heat source

- Solid fuel boiler.

Buffer tank loading by the boiler

- **Version 1:**
use of an anti-condensation pump unit **MCCS DN25**; Δt 20 K.
- **Version 2:**
use of an anti-condensation recirculation pump unit **M2 FIX3 CS DN25**; Δt 20 K.

Distribution

- Heating zone manifold **HV 60/125 DN25** for 3 pump units.

Heating users

- Low power radiator circuit, Δt 20 K:
unmixed pump unit **M2 DN25**
- Low power radiator circuit, Δt 20 K:
mixed pump unit **M2 MIX3 DN25**
- Low power underfloor heating circuit, Δt 8 K:
fixed temperature pump unit **M2 FIX3 DN25**.

Version 1

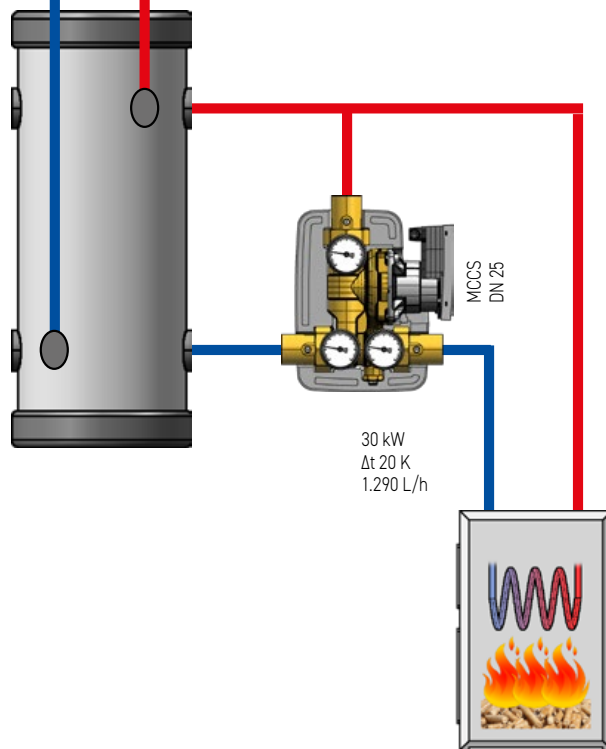

Version 2

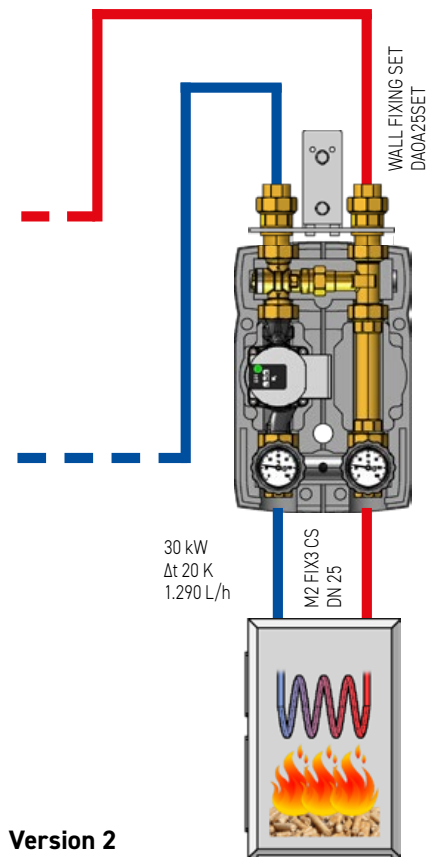

Note: the representations are to be considered just as an indication and they have no completeness pretension.

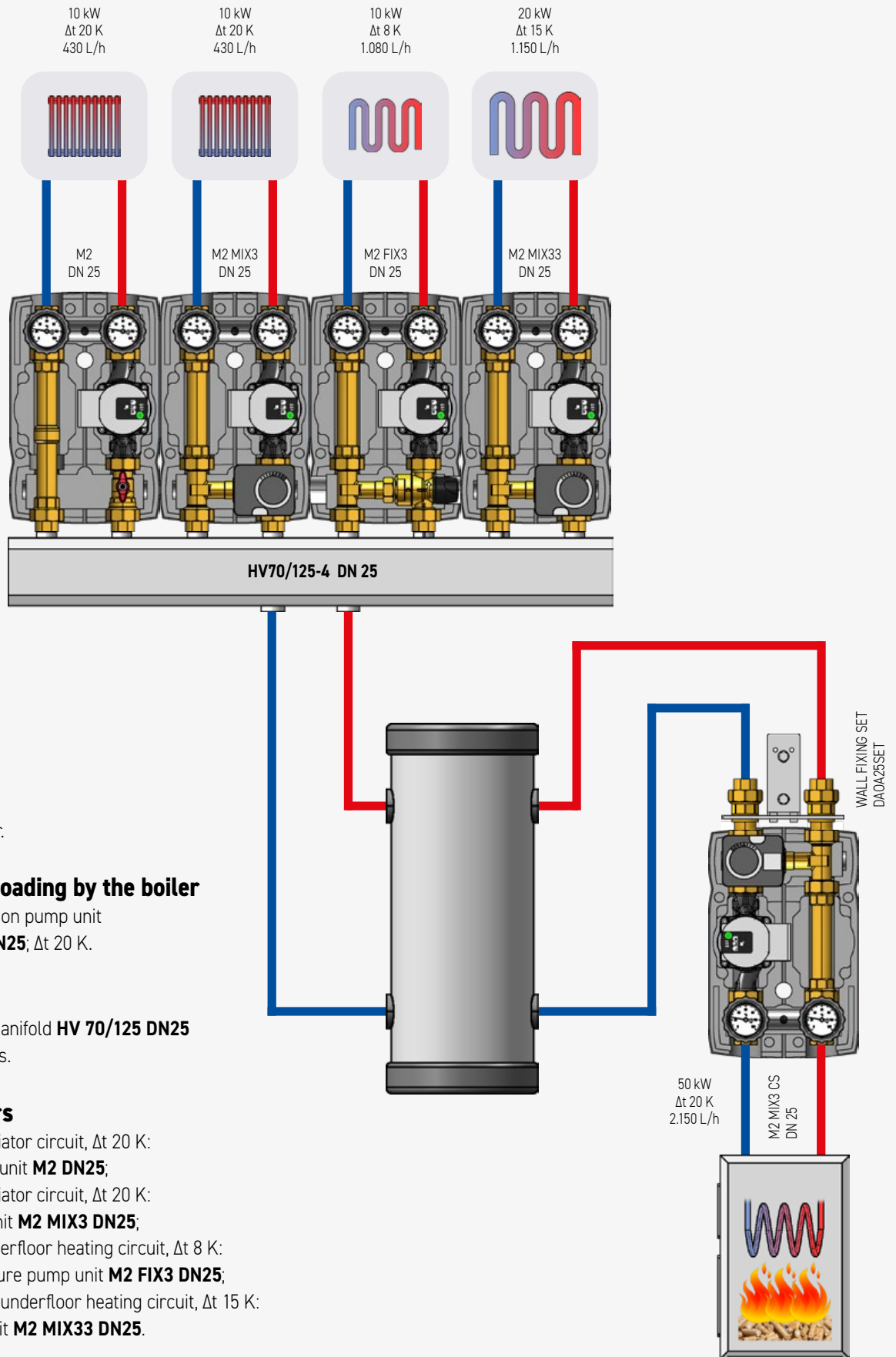

Note: the representations are to be considered just as an indication and they have no completeness pretension.

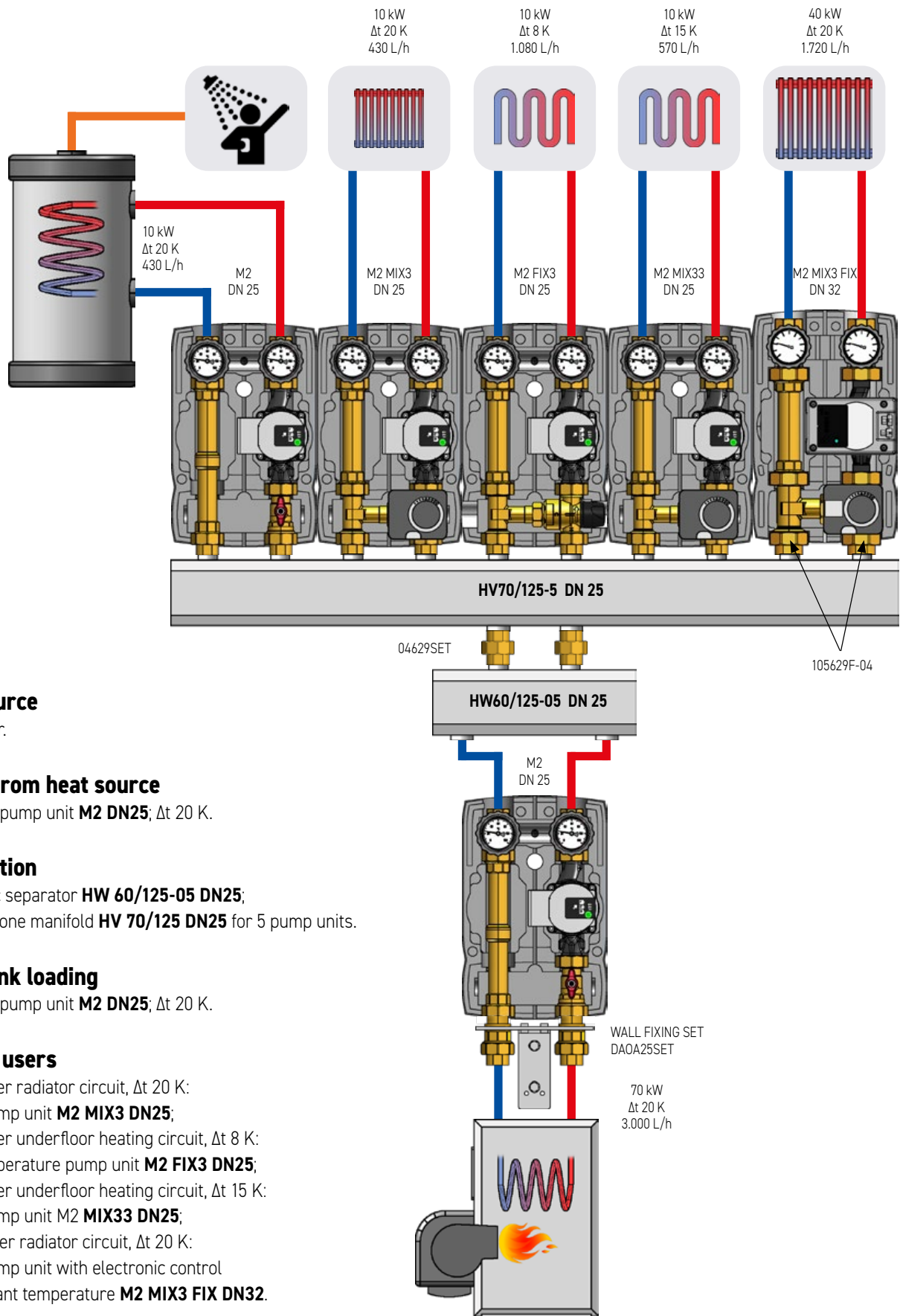

Heat source

- Gas boiler.

Supply from heat source

- Unmixed pump unit **M2 DN25**, Δt 20 K.

Distribution

- Hydraulic separator **HW 60/125-05 DN25**;
- Heating zone manifold **HV 70/125 DN25** for 5 pump units.

DHW tank loading

- Unmixed pump unit **M2 DN25**; Δt 20 K.

Heating users

- Low power radiator circuit, Δt 20 K: mixed pump unit **M2 MIX3 DN25**;
- Low power underfloor heating circuit, Δt 8 K: fixed temperature pump unit **M2 FIX3 DN25**;
- Low power underfloor heating circuit, Δt 15 K: mixed pump unit **M2 MIX33 DN25**;
- High power radiator circuit, Δt 20 K: mixed pump unit with electronic control for constant temperature **M2 MIX3 FIX DN32**.

Note: the representations are to be considered just as an indication and they have no completeness pretension.

ModvlvS DN25

The ModvlvS DN25 series is a complete range that meets all the installation needs with specific models: middle and low temperature heating systems, need of energy metering, cooling systems; everything with the possibility of a management control by means of climatic controllers even built-in the pump unit. DN25 pump units can be connected to heating systems with powers up to 50 kW, with a very low energy consumption ensured by high efficiency synchronous circulating pumps. The connections to the circuit or to the zone manifold are made with a 1" female thread. Moreover the pump units of M3 version are equipped with a by-pass balancing valve that allows an accurate regulation of the differential pressure of the loop. The range is supplemented by: zone manifolds, connections, safety units, mixing valves and actuators.



M2 2-WAY UNMIXED PUMP UNIT

The unit for 1" (180 mm) circulating pumps consists of:

Supply

- Connection.
- Flanged ball valve with T-handle.
- High efficiency synchronous pre-wired circulating pump (for the models that include it).
- Flanged ball valve supplied with in-handle thermometer (red ring, range 0°C-120°C).

Return

- Flanged ball valve with 20 mbar check valve (which can be excluded by rotating the handle by 45°) supplied with in-handle thermometer (blue ring; 0°C-120°C).
- Magnetic filter and ball valve (in the models where it is present)
- Connection.

Centre distance 125 mm. EPP insulation box (Dimensions: 250x380x170 mm).

PN 10, max temperature 110°C (unit without pump).

External connections: 1" Female.

FIELD OF USE

For power up to 50 kW (with Δt 20 K) and maximum flow rate 2150 l/h.
Kvs Value: 8.0.

Approximate data calculated with a 6 m head circulating pump. For an accurate sizing or for higher flow rates, please refer to the curve.



M3 3-WAY UNMIXED PUMP UNIT WITH BY-PASS

The unit for 1" (180 mm) circulating pumps is the same as the model M2. It is also equipped with a balancing by-pass valve (0-0.5 bar).

Code 1": **20358R**

With circulating pump: **20358R-(P6/A6/P8)**



Code 1": **20355R**

With circulating pump: **20355R-(P6/A6/P8)**

With magnetic filter: Code 1": **203652**

With circulating pump: **203652-(P6/A6/P8)**



Available circulating pumps:

Wilo Para 25/6 SC (P6)

Grundfos UPM3S Auto 25-60 (A6)

Wilo Para 25/8 SC (P8)



Available model provided with magnetic filter

CE



Available model provided with integrated magnetic filter



Standard version: right supply. Left supply version available with extra price: look at price list.

M2 MIX3

2-WAY PUMP UNIT WITH 3-WAY MIXING VALVE

The unit for 1" (180 mm) circulating pumps consists of:

Supply

- Connection.
- 3-way mixing valve.
- High efficiency synchronous pre-wired circulating pump (for the models that include it).
- Flanged ball valve supplied with in-handle thermometer (red ring, range 0°C-120°C).

Return

- Flanged ball valve with 20 mbar check valve (which can be excluded by rotating the handle by 45°) supplied with in-handle thermometer (blue ring, 0°C-120°C).
- Magnetic filter (in the models where it is present)
- "T" Connection for mixing valve.
- Connection.

Centre distance 125 mm. EPP insulation box (Dimensions: 250x380x170 mm).

PN 10, max temperature 110°C (unit without pump).

External connections: 1" Female.

FIELD OF USE

For power up to 35 kW (with Δt 20 K) and maximum flow rate 1500 l/h. Kvs Value: 6.0.

Approximate data calculated with a 6 m head circulating pump. For an accurate sizing or for higher flow rates, please refer to the curves shown in the technical section.

Available versions with reduced Kvs (using the special sets, see section "DN25 Equipments and accessories"). In the table below the resulting Kvs of the unit is shown, with the relevant maximum values of power and flowrate:

Mixing valve Kvs	Pump unit Kvs	Power	Flow rate
10,0 (std.)	6,0 (std.)	35 kW	1500 l/h
6,3	5,0	29 kW	1250 l/h
4,0	3,5	20 kW	850 l/h
2,5	2,4	14 kW	600 l/h



M3 MIX3

3-WAY PUMP UNIT WITH 3-WAY MIXING VALVE

The unit for 1" (180 mm) circulating pumps is the same as the model M2 MIX3.

It is also equipped with a balancing by-pass valve (0-0.5 bar).

Code 1": 20358R-M3

With circulating pump: 20358R-M3-(P6/A6/P8)

Standard version: right supply. Left supply version available with extra price: look at price list.



Code 1": 20355R-M3

With circulating pump: 20355R-M3-(P6/A6/P8)

With magnetic filter: Code 1": 203652-M3

With circulating pump: 203652-M3-(P6/A6/P8)



Available circulating pumps:

Wilo Para 25/6 SC (P6)

Grundfos UPM3S Auto 25-60 (A6)

Wilo Para 25/8 SC (P8)



Available model

provided with magnetic filter



It is recommended to install two isolating valves Art. 552 (see the section "DN25 Zone manifolds") with nut and gasket before the pump unit to allow an easy service or replacement of the components of the unit.

Code 1": 0266/M

M21D



Model with built-in actuator or climatic controller

M21D: 3 point actuator for mixing valve. Bidirectional, reversible with fixed limit switches for an operating range of 90°, 2 min., torque: 5 Nm. Power supply 230V. IP42.

AHD20



AHD20: Actuator with climatic controller and outside sensor. Optional room sensor. Bidirectional, reversible with fixed limit switches for an operating range of 90°, torque: 6 Nm. Power supply 230V. IP42.

Code 1": 20355R-M3-(M21/AHC)

With circulating pump:

20355R-M3-(P6/A6/P8)-(M21/AHC)



Optional check valve with seat holder washer

Check valve to be installed into the connection of the mixing valve on the return way. It prevents back flow rate of energy in presence of complex installations (e.g. different circulating pumps and/or several mixing valves on the zone manifold). Minimum opening pressure: 20 mbar. Kvs 8.8. Max Temperature 110°C.



Code: SET10101

DN25 PUMP UNITS

3-WAY MIXED

LOW TEMPERATURE

M2 MIX33

2-WAY PUMP UNIT WITH 3-WAY MIXING VALVE WITH BUILT-IN BY-PASS

The unit for 1" (180 mm) circulating pumps consists of:

Supply

- Connection.
- 3-way mixing valve with adjustable by-pass. Through the by-pass (adjustable from the front part) it is possible to mix on the supply line a quantity of water coming back from the return line of the system.
- High efficiency synchronous pre-wired circulating pump (for the models that include it).
- Flanged ball valve supplied with in-handle thermometer (red ring, range 0°C-120°C).

Return

- Flanged ball valve with 20 mbar check valve (which can be excluded by rotating the handle by 45°) supplied with in-handle thermometer (blue ring; 0°C-120°C).
- Magnetic filter (in the models where it is present)
- "T" Connection for mixing valve.
- Connection.

Centre distance 125 mm. EPP insulation box (Dimensions: 250x380x170 mm).

PN 10, max temperature 110°C (unit without pump).

External connections: 1" Female.

FIELD OF USE

For power up to 38 kW (with Δt 15 K) and maximum flow rate 2200 l/h. Kvs Value: 7.0.

For an accurate sizing or for higher flow rates, please refer to the curves shown in the technical section.



Code 1": **20355R-M33**

With circulating pump: **20355R-M33-(P6/A6/P8)**

With magnetic filter: Code 1": **203652-M33**

With circulating pump: **203652-M33-(P6/A6/P8)**



Available circulating pumps:

Wilo Para 25/6 SC (P6)

Grundfos UPM3S Auto 25-60 (A6)

Wilo Para 25/8 SC (P8)



Available model provided with magnetic filter



It is recommended to install two isolating valves **Art. 552** (see the section "DN25 Zone manifolds") with nut and gasket before the pump unit to allow an easy service or replacement of the components of the unit.



Code 1": **0266/M**



Integrated by-pass

The by-pass integrated into the 3-way mixing valve ensures a recirculation inside the installation, even when the mixing valve is fully open. Through the by-pass, a fixed percent of the mixing can be set, in the case when the flow through the mixing valve is not sufficient. In case of a bad working of the system causing an increase of the temperature of the installation, the recirculation through the by-pass allows a decrease of the water temperature in the underfloor installation, by mixing the warm water of the return circuit with the hot water of the supply circuit, reducing possible damages. **M2 MIX33 pump units are supplied with the recirculation by-pass fully open.**

Approximate data for applications in low and medium temperature heating systems

Δt	Approximate power and flow rate of the application	Recommended circulating pump	Residual head	Approximate surface of the underfloor heating system
8 K	17 kW - 1800 l/h	Wilo Para 25/6 SC	3 mH ₂ O	Up to 100 m ²
8 K	20 kW - 2200 l/h	Wilo Para 25/8 SC	5 mH ₂ O	Up to 200 m ²
15 K	31 kW - 1800 l/h	Wilo Para 25/6 SC	3 mH ₂ O	-
15 K	38 kW - 2200 l/h	Wilo Para 25/8 SC	5 mH ₂ O	-

Operating principle

During normal operation, for example with the mixer completely closed on the recirculation, a part of the fluid is sucked by the pump all along the by-pass line. As a result, a very high user flow rate is obtained at a reduced temperature.

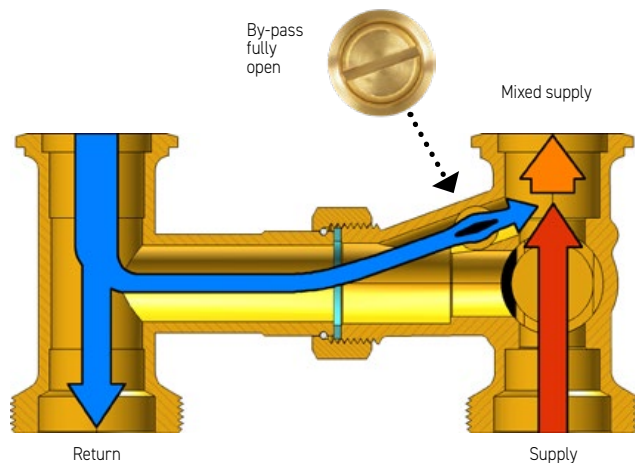

Adjusting the by-pass

The by-pass is **fully open** and it allows the maximum recirculation. The screwdriver cut is aligned along the reference indicator.

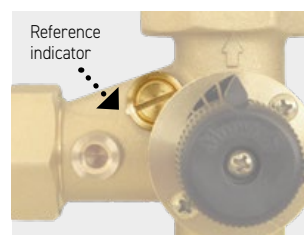

The by-pass is **fully closed** and there is no recirculation. The screwdriver cut is in an orthogonal position (at 90°) in comparison with the reference indicator.

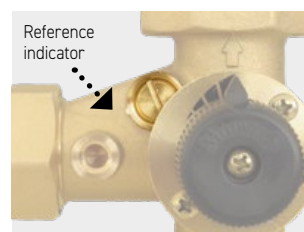

Model with built-in actuator or climatic controller



M21D

M21D: 3 point actuator for mixing valve. Bidirectional, reversible with fixed limit switches for an operating range of 90°, 2 min., torque: 5 Nm. Power supply 230V. IP42.



AHD20

AHD20: Actuator with climatic controller and outside sensor. Optional room sensor. Bidirectional, reversible with fixed limit switches for an operating range of 90°, torque: 6 Nm. Power supply 230V. IP42.

Code 1": **20355R-M33-(M21/AHC)**
 With circulating pump: **20355R-M33-(P6/A6/P8)(M21/AHC)**



Optional check valve with seat holder washer

Check valve to be installed into the connection of the mixing valve on the return way. It prevents back flow rate of energy in presence of complex installations (e.g. different circulating pumps and/or several mixing valves on the zone manifold). Minimum opening pressure: 20 mbar. Kvs 8.8. Max Temperature 110°C.



Code: **SET10101**



M3 MIX33 3-WAY PUMP UNIT WITH BY-PASS AND 3-WAY MIXING VALVE WITH BUILT-IN BY-PASS

The unit for 1" (180 mm) circulating pumps is the same as the model M2 MIX33.

It is also equipped with a balancing by-pass valve (0-0.5 bar).

Code 1": **20358R-M33**
 With circulating pump: **20358R-M33-(P6/A6/P8)**

Standard version: right supply. Left supply version available with extra price: look at price list.

DN25 PUMP UNITS

4-WAY MIXED

M2 MIX4

2-WAY PUMP UNIT WITH 4-WAY MIXING VALVE

The unit for 1" (180 mm) circulating pumps consists of:

Supply

- Connection.
- 4-way mixing valve.
- High efficiency synchronous pre-wired circulating pump (for the models that include it).
- Flanged ball valve supplied with in-handle thermometer (red ring, range 0°C-120°C).

Return

- Flanged ball valve with 20 mbar check valve (which can be excluded by rotating the handle by 45°) supplied with in-handle thermometer (blue ring, 0°C-120°C).
- Connection.

Centre distance 125 mm.

EPP insulation box (Dimensions: 250x380x170 mm).

PN 10, max temperature 110°C (unit without pump).

External connections: 1" Female.

FIELD OF USE

For power up to 28 kW (with Δt 20 K) and maximum flow rate 1200 l/h. Kvs Value: 5.0.

Approximate data calculated with a 6 m head circulating pump. For an accurate sizing or for higher flow rates, please refer to the curves shown in the technical section.

Model with built-in actuator or climatic controller

M21D: 3 point actuator for mixing valve. Bidirectional, reversible with fixed limit switches for an operating range of 90°, 2 min., torque: 5 Nm. Power supply 230V. IP42.

M21D



AHD20: Actuator with climatic controller and outside sensor. Optional room sensor. Bidirectional, reversible with fixed limit switches for an operating range of 90°, torque: 6 Nm. Power supply 230V. IP42.

AHD20



Code 1": **20355R-M4-(M21/AHC)**

With circulating pump: **20355R-M4-(P6/A6/P8)-(M21/AHC)**

M3 MIX4

3-WAY PUMP UNIT WITH BY-PASS AND 4-WAY MIXING VALVE

Code 1": **20358R-M4**

With circulating pump: **20358R-M4-(P6/A6/P8)**

Standard version: right supply. Left supply version available with extra price: look at price list.



Code 1": **20355R-M4**

With circulating pump: **20355R-M4-(P6/A6/P8)**



Available circulating pumps:

Wilo Para 25/6 SC **(P6)**

Grundfos UPM3S Auto 25-60 **(A6)**

Wilo Para 25/8 SC **(P8)**



It is recommended to install two isolating valves **Art. 552** (see the section "DN25 Zone manifolds") with nut and gasket before the pump unit to allow an easy service or replacement of the components of the unit.

Code 1": **0266/M**



Optional check valve for mixed pump units

Check valve to be installed into the body of the mixing valve on the return way. It prevents back flow rate of energy in presence of complex installations (e.g. different circulating pumps and/or several mixing valves on the zone manifold). Minimum opening pressure: 20 mbar. Kvs 8.8. Max Temperature 110°C.



Code: **10101**

The unit for 1" (180 mm) circulating pumps is the same as the model M2 MIX4.

It is also equipped with a balancing by-pass valve (0-0.5 bar).

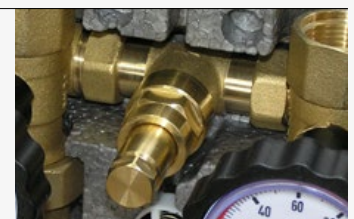

M2 FIX3

2-WAY PUMP UNIT WITH FIXED TEMPERATURE THERMOSTATIC MIXING VALVE

The unit for 1" (180 mm) circulating pumps consists of:

Supply

- Connection.
- Adjustable thermostatic mixing valve, models F1, F2, F3 and F4.
- High efficiency synchronous pre-wired circulating pump (for the models that include it).
- Flanged ball valve supplied with in-handle thermometer (red ring, range 0°C-120°C).

Return

- Flanged ball valve with 20 mbar check valve (which can be excluded by rotating the handle by 45°) supplied with in-handle thermometer (blue ring; 0°C-120°C).
- "T" Connection for mixing valve.
- Connection.

Centre distance 125 mm. EPP insulation box (Dimensions: 250x380x170 mm).

PN 10, max temperature 110°C (unit without pump).

External connections: 1" Female.

FIELD OF USE

For power up to 35 kW (with Δt 20 K) and maximum flow rate 1500 l/h.

Kvs Value: please refer to the table below. For an accurate sizing or higher flow rates, please refer to the curves shown in the technical section.

Approximate data for underfloor and radiator heating systems

Model	Setting range	Δt	Kvs	Approximate power and flow rate of the application	Recommended circulating pump	Residual head	Approximate surface of the underfloor heating system
F1	20-45°C	8 K	2,2	4,5 kW - 500 l/h	Wilo Para 25/6 SC	5 mH ₂ O	Up to 50 m ²
F2	45-70°C	20 K	2,2	11 kW - 500 l/h	Wilo Para 25/6 SC	5 mH ₂ O	-
F3	20-45°C	8 K	3,3	14 kW - 1500 l/h	Wilo Para 25/8 SC	5 mH ₂ O	From 50 m ² up to 150 m ²
F4	45-70°C	20 K	3,3	35 kW - 1500 l/h	Wilo Para 25/8 SC	5 mH ₂ O	-

Thanks to the **Multimix** thermostatic mixing valve the pump unit can deliver the maximum supply temperature, the same as the one of the inlet hot water. If lower temperatures are requested, to allow a regular and continuous mixing, it is necessary that the inlet hot water temperature is 3÷5 K higher than the requested value of the outlet mixed temperature. Reference temperatures: **F1** and **F3** models: Th: 55°C ; Tc: 24°C ; Tmix: 32°C - **F2** and **F4** models: Th: 75°C ; Tc: 40°C ; Tmix: 55°C.



Note: The use in a cooling circuit inhibits thermostatic regulation, therefore for this application the functionality will be equivalent to that of an unmixed group.



It is recommended to install two isolating valves **Art. 552** (see the section "DN25 Zone manifolds") with nut and gasket before the pump unit to allow an easy service or replacement of the components of the unit.

Code 1": **0266/M**



Optional check valve with seat holder washer

Check valve to be installed into the connection of the mixing valve on the return way. It prevents back flow rate of energy in presence of complex installations (e.g. different circulating pumps and/or several mixing valves on the zone manifold). Minimum opening pressure: 20 mbar. Kvs 8.8. Max Temperature 110°C.

Code: **SET10101**



Standard version: right supply. Left supply version available with extra price: look at price list.



Code: **20355R-(F1/F2/F3/F4)**

With circulating pump:

20355R-(F1/F2/F3/F4)-(P6/A6/P8)



Available circulating pumps:

Wilo Para 25/6 SC (**P6**)

Grundfos UPM3S Auto 25-60 (**A6**)

Wilo Para 25/8 SC (**P8**)



Available thermostatic mixing valves:

Setting range: 20-45°C (**F1-F3**)

Setting range: 45-70°C (**F2-F4**)



Optional: safety bimetallic thermostat

Supplied in the group by adding "-T" (see section "Actuators and Room Thermostats"). Code example: **20355R-F3-P6-T**



M3 FIX3

3-WAY PUMP UNIT WITH BY-PASS AND FIXED TEMPERATURE THERMOSTATIC MIXING VALVE

The unit for 1" (180mm) circulating pumps is the same as the model M2 FIX3. It is also equipped with a balancing by-pass valve (0-0.5 bar).

Code 1": **20358R-(F1/F2/F3/F4)**

With circulating pump:

20358R-(F1/F2/F3/F4)-(P6/A6/P8)

DN25 PUMP UNITS FIXED TEMPERATURE HIGH POWER

M2 MIX3 FIX

2-WAY PUMP UNIT WITH 3-WAY MIXING VALVE WITH ELECTRONIC CONTROL FOR CONSTANT TEMPERATURE. HEATING AND COOLING

The unit for 1" (180 mm) circulating pumps consists of:

Supply

- Connection.
- 3-way mixing valve with electronic actuator.
- High efficiency synchronous pre-wired circulating pump (for the models that include it).
- Flanged ball valve supplied with in-handle thermometer (red ring, range 0°C-120°C).
- Temperature sensor.
- Bimetallic unipolar thermostat, 20-90°C, with contact by interruption or switching.

Return

- Flanged ball valve with 20 mbar check valve (which can be excluded by rotating the handle by 45°) supplied with in-handle thermometer (blue ring; 0°C-120°C).
- "T" Connection for mixing valve.
- Connection.

Centre distance 125 mm.

EPP insulation box (Dimensions: 250x380x170 mm).

PN 10, max temperature 110°C (unit without pump).

External connections: 1" Female.

FIELD OF USE

For power up to 35 kW (with Δt 20 K) and maximum flow rate 1500 l/h. Kvs Value: 6.0.

Approximate data calculated with a 6 m head circulating pump. For an accurate sizing or for higher flow rates, please refer to the curves shown in the technical section.



The electronics of the actuator keeps constant the set temperature of the supply way, monitoring it by means of a sensor (included) mounted on the pipe. Display of the measured temperature and target temperature, on reversible LCD display.



Setting of target temperature adjustable from 5°C up to 90°C. Operating range of 90°. Power supply 230V, torque 6 Nm. IP42.

M3 MIX3 FIX

3-WAY PUMP UNIT WITH BY-PASS AND 3-WAY MIXING VALVE WITH ELECTRONIC ACTUATOR FOR CONSTANT TEMPERATURE. HEATING AND COOLING

Code 1": 20358R-M3F-CT

with circulating pump: 20358R-M3F-(P6/A6/P8)-CT



Code 1": 20355R-M3F-CT

With circulating pump: 20355R-M3F-(P6/A6/P8)-CT



Available circulating pumps:

Wilo Para 25/6 SC (P6)

Grundfos UPM3S Auto 25-60 (A6)

Wilo Para 25/8 SC (P8)



It is recommended to install two isolating valves **Art. 552** (see the section "DN25 Zone manifolds") with nut and gasket before the pump unit to allow an easy service or replacement of the components of the unit.



Code 1": 0266/M

Optional check valve with seat holder washer

Check valve to be installed into the connection of the mixing valve on the return way. It prevents back flow rate of energy in presence of complex installations (e.g. different circulating pumps and/or several mixing valves on the zone manifold). Minimum opening pressure: 20 mbar. Kvs 8.8. Max Temperature 110°C.

Code: SET10101



The unit for 1" (180 mm) circulating pumps is the same as the model M2 MIX3.

It is also equipped with a balancing by-pass valve (0-0.5 bar).



Standard version: right supply. Left supply version available with extra price: look at price list.

CLIMA M

2-WAY PUMP UNIT WITH 3-WAY MIXING VALVE WITH BUILT-IN BY-PASS AND BUILT-IN CLIMATIC CONTROLLER FOR ONE MIXED HEATING CIRCUIT

Climatic control pump unit for a mixed heating system, control of boiler contact 0-10 V or PWM (heat source) for starting and switching off.

It is possible to connect one each other several hydraulic modules via CAN-Bus and to connect the °Caleon room controller. The pump unit, by acquiring the value of the outside temperature, settles the right supply temperature of the installation on the base of the set climatic curve.

The unit is supplied completely assembled and tested. No wiring operations are needed: the circulating pump, the actuator of mixing valve and the climatic controller are pre-wired for a practical and effective installation.

The unit for 1" (180 mm) circulating pumps consists of:

Supply

- Connection.
- Isolating flanged ball valve with unions.
- 3-way mixing valve with 3 point actuator and adjustable by-pass. Through the by-pass (adjustable from the front part) it is possible to mix on the supply line a quantity of water coming back from the return line of the system.
- High efficiency synchronous circulating pump: Wilo Para SC with 6 m or 8 m head.
- Flanged ball valve supplied with in-handle thermometer (red ring, range 0°C-120°C).

Return

- Flanged ball valve with 20 mbar check valve (which can be excluded by rotating the handle by 45°) supplied with in-handle thermometer (blue ring; 0°C-120°C).
- "T" connection for mixing valve.
- Isolating flanged ball valve with unions.
- Connection.

Centre distance 125 mm.

EPP insulation box (Dimensions: 250x466x215 mm).

A special back plate fixes the unit to the insulation box and allows a quick fitting to the wall or to the buffer tank.

PN 10, max temperature 110°C

External connections: 1" Female.



Code 1": **20359R-M33-MHC(P6/P8)**



FIELD OF USE

For power up to 38 kW (with Δt 15 K) and maximum flow rate 2200 l/h. Kvs Value: 7.0.

Approximate data calculated with a Wilo Para SC 25/6 circulating pump (6 m head).
For power up to 20 kW (with Δt 8 K) and maximum flow rate 2200 l/h. Kvs Value: 7.0.

Approximate data calculated with a Wilo Para SC 25/8 circulating pump (8 m head). For an accurate sizing or higher flow, please refer to the curves of the circulating pumps (constant Δp and variable Δp), which are available in the next page.

Mixing valve with actuator and adjustable by-pass

3-way mixing valve with bi-directional actuator with an operating range of 90°; led of activity in opening and closing mode. Selector for manual working by means of the indicator handwheel. A special connector allows to replace the actuator in case of failure or bad working without having to operate on electric wires.

The by-pass integrated into the 3-way mixing valve ensures a recirculation inside the installation, even when the mixing valve is fully open (particularly suitable for underfloor heating systems). Through the by-pass a fixed percent of the mixing can be set, in the case when the flow through the mixing valve is not sufficient.

Pump units are supplied with the recirculation by-pass fully open.

Kvs value of the mixing valve: 15.0.



DN25 PUMP UNITS CLIMA M FOR A MIXED SYSTEM

Circulating Pumps

Wilo Para SC 25/6 and 25/8

High efficiency circulating pumps with electronically commutated motor. Integrated differential pressure control: constant Δp or variable Δp .

Constant Δp : for heating circuits with a stable pressure drop (e.g. underfloor heating) or plants where the pressure drop of pipes is negligible in comparison with the pressure drop of the thermostatic radiator valves, or where independently from open thermostatic radiator valves, same differential pressure is requested.

Variable Δp : in order to achieve the max energy saving and noise reduction. It is recommended in plants where the pressure drop of the pipes is higher than the pressure drops of the regulating valves, or more simply, when the requested differential pressure is decreasing when the flow comes down.

In compliance with European Directive 2009/125/CE. Low energy consumption from 4 W to 43 W (Wilo Para SC 25/6) and from 10 W to 75 W (Wilo Para SC 25/8) at max flow. Automatic deaerator program, which allows a quick elimination of air during the first start of the plant. Molex automatic connector, which allows to replace the circulating pump in case of failure or bad working, without having to operate on electric wires.

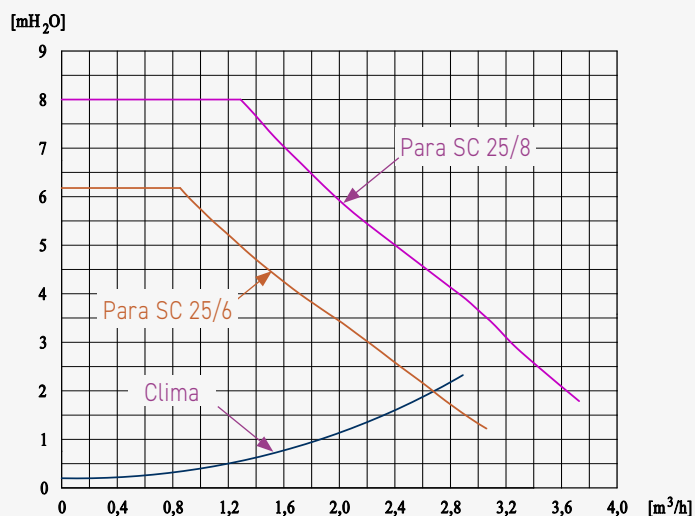

Climatic Controller Clima M

It is possible to connect the room controller °Caleon

Climatic controller with wide LCD display to manage a mixed heating circuit.

- Mixed loop pictogram with evidence of the relay activity state: circulating pump and mixing valve in opening or in closing. Request of heat source.
- CAN-Bus connection to connect several pump units.
- Possibility of remote control and data backup thanks to the Connect system (the special Datalogger, not included, is necessary).
- Visualization of temperature of sensors: outside sensor, supply sensor, calculated supply sensor and room sensor (optional). Active modality of working: day or night.
- Pre-setting of performance curve with linear slope or broken and related day-night correctors.
- Protection function: anti-blockage circulating pump, anti-frost control, min and max supply temperature.
- Daily up to three time bands can be set up: active heating circuit in day modality or reduction night.
- Data memory with statistical analysis of the working of the plant (temperatures, working times, error messages, etc).
- Room controller °Caleon (optional). Elegant climatic control unit equipped with a touch-screen color display. It allows an easy remote management of the heating system. Operation modality: Normal, Turbo, Eco and Off with specific temperature set-point. Holiday program. 8 Selectable daily heating time slot.

The controller is supplied with the following sensors (PT1000):

- Power cable with Schuko plug;
- Cable for controlling circulating pump with Molex connector;
- Cable for controlling actuator with automatic connector PR120;
- Temperature sensor for mixed circuit TR/S1.5;
- Cable with external "sensor box" for: external sensor TA/55, room controller °Caleon (optional), 0-10V boiler contact, 24 VDC supply (output).
- Outside temperature sensor TA/55.

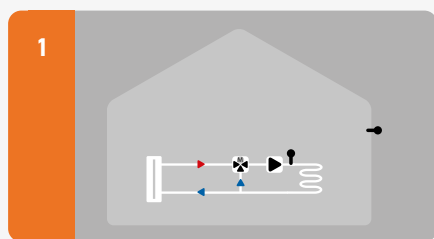

Mixed circuit

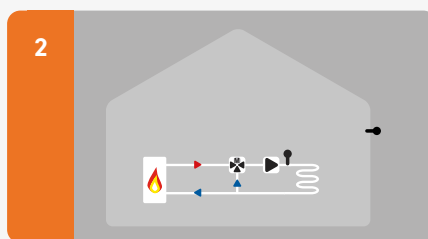

Mixed circuit + boiler (*)

(*) Boiler control is 0-10V or PWM. To change the signal into potential free please use the outside optional relay.

Outside relay

Outside relay 1W6A. It includes the protection box, it must be used when the 0-10V output of the controller has to be transformed into potential free control.

- Coil voltage 9-12 VDC
- Maximum commutation voltage: 250 VAC
- Maximum commutation current: 6A (AC1)
- Insulation box IP54

Code: **RELE-1W6A**



CAN-Bus cable

Connection CAN-Bus cable 1 metre long, including 2 final resistors to close the circuit.

Code: **CABLE-CAN1**



CLIMA L

2-WAY PUMP UNIT WITH 3-WAY MIXING VALVE WITH BUILT-IN BY-PASS AND BUILT-IN CLIMATIC CONTROLLER FOR COMPLEX INSTALLATIONS

Climatic control pump unit for 1 or 2 circuits and heat request (heat source), DHW production or solar circuit; control of the cooling system. It is possible to connect one each other several hydraulic modules via CAN-Bus and to connect the °Caleon room room controller. The pump unit, by acquiring the value of the outside temperature, settles the right supply temperature of the installation on the base of the set climatic curve. The unit is supplied completely assembled and tested. No wiring operations are needed: the circulating pump, the actuator of mixing valve and the climatic controller are pre-wired for a practical and effective installation.

The unit for 1" (180 mm) circulating pumps consists of:

Supply

- Connection.
- Isolating flanged ball valve with unions.
- 3-way mixing valve with 3 point actuator and adjustable by-pass. Through the by-pass (adjustable from the front part) it is possible to mix on the supply line a quantity of water coming back from the return line of the system.
- High efficiency synchronous circulating pump: Wilo Para SC with 6 m or 8 m head.
- Flanged ball valve supplied with in-handle thermometer (red ring, range 0°C-120°C).

Return

- Flanged ball valve with 20 mbar check valve (which can be excluded by rotating the handle by 45°) supplied with in-handle thermometer (blue ring; 0°C-120°C).
- "T" connection for mixing valve.
- Isolating flanged ball valve with unions.
- Connection.

Centre distance 125 mm.

EPP insulation box (Dimensions: 250x466x215 mm).

A special back plate fixes the unit to the insulation box and allows a quick fitting to the wall or to the buffer tank.

PN 10, max temperature 110°C

External connections: 1" Female.



Code 1": 20359R-M33-LHC(P6/P8)



FIELD OF USE

For power up to 38 kW (with Δt 15 K) and maximum flow rate 2200 l/h. Kvs Value: 7.0.

Approximate data calculated with a Wilo Para SC 25/6 circulating pump (6 m head).

For power up to 20 kW (with Δt 8 K) and maximum flow rate 2200 l/h. Kvs Value: 7.0.

Approximate data calculated with a Wilo Para SC 25/8 circulating pump (8 m head). For an accurate sizing or higher flow, please refer to the curves of the circulating pumps (constant Δp and variable Δp), which are available in the next page.

Mixing valve with actuator and adjustable by-pass

3-way mixing valve with bi-directional actuator with an operating range of 90°; led of activity in opening and closing mode. Selector for manual working by means of the indicator handwheel. A special connector allows to replace the actuator in case of failure or bad working without having to operate on electric wires.

The by-pass integrated into the 3-way mixing valve ensures a recirculation inside the installation, even when the mixing valve is fully open (particularly suitable for underfloor heating systems). Through the by-pass a fixed percent of the mixing can be set, in the case when the flow through the mixing valve is not sufficient.

Pump units are supplied with the recirculation by-pass fully open.

Kvs value of the mixing valve: 15.0.



Circulating Pumps

Wilo Para SC 25/6 and 25/8

High efficiency circulating pumps with electronically commutated motor. Integrated differential pressure control: constant Δp or variable Δp .

Constant Δp : for heating circuits with a stable pressure drop (e.g. underfloor heating) or plants where the pressure drop of pipes is negligible in comparison with the pressure drop of the thermostatic radiator valves, or where independently from open thermostatic radiator valves, same differential pressure is requested.

Variable Δp : in order to achieve the max energy saving and noise reduction. It is recommended in plants where the pressure drop of the pipes is higher than the pressure drops of the regulating valves, or more simply, when the requested differential pressure is decreasing when the flow comes down.

In compliance with European Directive 2009/125/CE. Low energy consumption from 4 W to 43 W (Wilo Para SC 25/6) and from 10 W to 75 W (Wilo Para SC 25/8) at max flow. Automatic deaerator program, which allows a quick elimination of air during the first start of the plant. Molex automatic connector, which allows to replace the circulating pump in case of failure or bad working, without having to operate on electric wires.

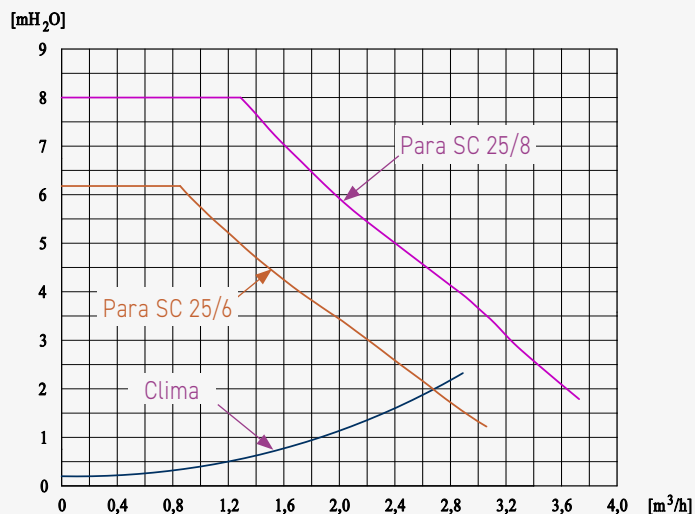

Climatic Controller Clima L

Climatic controller with wide LCD display to manage complex installations.

- Pictogram of selected hydraulic circuit with indication of the relays activity status: circulators, valves (mixing or diverting) and request of energy source.
- CAN-Bus connection to connect several pump units.
- Possibility of remote control and data backup thanks to the Connect system (the special Datalogger, not included, is necessary).
- Visualization of temperature of sensors. Active modality of working: day or night.
- Pre-setting of performance curves (1 or 2 circuits) with linear slope or broken and related day-night correctors.
- Protection function: anti-blockage circulating pump, anti-frost control, min and max supply temperature.
- Daily up to three time bands can be set up: active circuit in day modality or reduction night.
- Data memory with statistical analysis of the working of the plant (temperatures, working times, error messages, etc).
- Room controller °Caleon (optional). Elegant climatic control unit equipped with a touch-screen color display. It allows an easy remote management of the heating system. Operation modality: Normal, Turbo, Eco and Off with specific temperature set-point. Holiday program. 8 Selectable daily heating time slot;
- Cooling mode with controller °Caleon Clima.

The controller is supplied pre-cabled and with the following sensors (PT1000):

- Power cable with Schuko plug;
- Cable for controlling circulating pump with Molex connector;
- Cable for controlling actuator with automatic connector PR120;
- Temperature sensor for mixed circuit TR/S1.5;
- Pre-wired power box for the relay R4 management;
- Pre-wired sensor box for connecting the 5 sensors of the system, the room controller °Caleon (1 or 2 depending on the hydraulic diagram selected) and the 2 additional 0/10V free outputs. One of these outputs can be transformed into open or closed contact thanks to a relay built in the sensor box (up to 6A). All cabling is thus eased without having to access the control unit;
- Outside temperature sensor TA/55.



It is possible to connect the room thermostat °Caleon

Some examples of hydraulic diagrams controlled by the Clima L

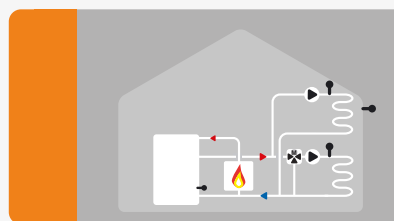

Mixed heating circuit, unmixed circuit and boiler or heat pump

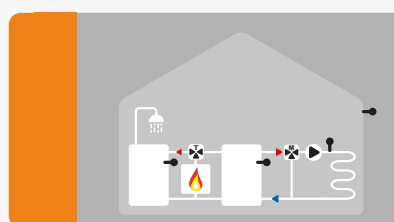

Mixed heating circuit, boiler, diverting valve and DHW tank

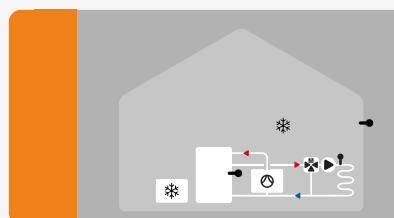

Mixed heating circuit, heat pump with cooling function; dehumidifier

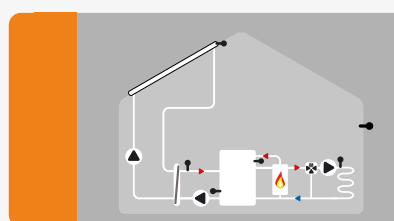

Mixed heating circuit, solar circuit with exchanger, boiler or heat pump

ModvlvS Energy

The pump units Energy are designed to meter the energy in centralized heating and cooling installations. These pump units, thanks to two isolating valves on the return way, allow an easy mounting of the heat/cooling energy meter. The second temperature sensor is directly put into isolating valve of the supply way, without any adapter or pit. This special 3-way ball valve, placed after the circulating pump, allows the lead sealing of the sensor and also the replacement of it without draining the installation: just close the valve to isolate the sensor from the hydraulic circuit. In this way the installation of the heat/cooling energy meter, after having cleaned and serviced the circuit or replaced it, is very easy.

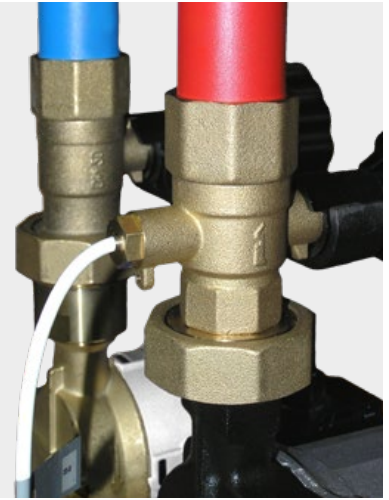

M2 Energy

2-WAY UNMIXED PUMP UNIT DESIGNED TO FIT A HEAT/COOLING ENERGY METER

The unit for 1" (180 mm) circulating pumps consists of:

Supply

- Connection.
- Flanged ball valve with T-handle.
- High efficiency synchronous pre-wired circulating pump (for the models that include it).
- 3-way flanged ball valve supplied with in-handle thermometer (red ring, range 0°C-120°C). The third way M10x1 allows the dip fitting and the lead sealing of a $\varnothing 5 \times 45$ mm sensor.

Return

- Flanged ball valve with 20 mbar check valve (which can be excluded by rotating the handle by 45°) supplied with in-handle thermometer (blue ring; 0°C-120°C).
- Distance piece made of plastic 1"x130mm that has to be removed, after having cleaned the installation, to fit the heat/cooling energy meter
- Flanged ball valve with T-handle.
- Connection.

Centre distance 125 mm.

EPP insulation box (Dimensions: 250x380x170 mm).

PN 10, max temperature 90°C.

External connections: 1" Female.

FIELD OF USE

For power up to 50 kW (with Δt 20 K) and maximum flow rate 2150 l/h (*).
Kvs value: 8.0 (*).

Approximate data calculated with a 6 m head circulating pump.
For an accurate sizing or for higher flow rates, please refer to the curves shown in the technical section.

(*) The data are relevant to the pump unit without circulating pump and without heat/cooling energy meter installed.



Code 1": 203518-20

With circulating pump: 203518-(P6/A6/P8)-20



Available circulating pumps:
Wilo Para 25/6 SC (P6)
Grundfos UPM3S Auto 25-60 (A6)
Wilo Para 25/8 SC (P8)



Installable heat/cooling energy meters:
DN20 - 1" x 130
Qn 2,5 (20)



M2 MIX3 Energy

**2-WAY PUMP UNIT WITH 3-WAY MIXING VALVE
DESIGNED TO FIT A HEAT/COOLING ENERGY METER**

The unit for 1" (180 mm) circulating pumps consists of:

Supply

- Connection.
- 3-way mixing valve.
- High efficiency synchronous pre-wired circulating pump (for the models that include it).
- 3-way flanged ball valve supplied with in-handle thermometer (red ring, range 0°C-120°C). The third way M10x1 allows the dip fitting and the lead sealing of a $\varnothing 5 \times 45$ mm sensor.

Return

- Flanged ball valve with 20 mbar check valve (which can be excluded by rotating the handle by 45°) supplied with in-handle thermometer (blue ring; 0°C-120°C).
- Distance piece made of plastic 1"x130mm that has to be removed, after having cleaned the installation, to fit the heat/cooling energy meter.
- "T" Connection for mixing valve.
- Connection.

Centre distance 125 mm.

EPP insulation box (Dimensions: 250x380x170 mm).

PN 10, max temperature 90°C.

External connections: 1" Female.

FIELD OF USE

**For power up to 35 kW (with Δt 20 K) and maximum flow rate 1500 l/h (*).
Kvs value: 6.0 (*).**

Approximate data calculated with a 6 m head circulating pump. For an accurate sizing or for higher flow rates, please refer to the curves shown in the technical section.

(* The data are relevant to the pump unit without circulating pump and without heat/cooling energy meter installed.

It is recommended to install two isolating valves **Art. 552** (see the section "DN25 Zone manifolds") with nut and gasket before the pump unit to allow an easy service or replacement of the components of the unit.



Code 1": **0266/M**



Code 1": **203518-M3-20**

With circulating pump: **203518-M3-(P6/A6/P8)-20**



Available circulating pumps:

- Wilo Para 25/6 SC (**P6**)
- Grundfos UPM3S Auto 25-60 (**A6**)
- Wilo Para 25/8 SC (**P8**)



Installable heat/cooling energy meters:

- DN20 - 1" x 130
- Qn 2,5 (**20**)



Optional check valve with seat holder washer

Check valve to be installed into the connection of the mixing valve on the return way. It prevents back flow rate of energy in presence of complex installations (e.g. different circulating pumps and/or several mixing valves on the zone manifold). Minimum opening pressure: 20 mbar. Kvs 8.8. Max Temperature 110°C.



Code: **SET10101**

G21

HEAT/COOLING ENERGY METER SUITABLE FOR HEATING AND COOLING



Code: **G21MID-2.5**

DN20
1" x 130 mm
Qn 2,5



Compact conductance scanning heat/cooling energy meter, with storage of 18 monthly remote values, with storage of year consumption starting from the reference day and checknumber. Optical interface for coding and/or reading. The connection of external communication modules is possible. MID approved.

- Flow metering by means of turbine single jet volumetric system with survey of the number of turns in accordance with the electric conductance principle, so without the use of magnets.
- IrDA optical interface to set parameters and to read data, using compatible mobile peripherals.
- Specific optical interface to connect an additional communication module: radio communication, M-Bus or pulse output.
- PT1000 Temperature sensor for supply way $\varnothing 5 \times 45$ mm, 1.5 m long.
- MID approved and lithium buffer battery 10 years life.
- Nominal flow: 2.5 m³/h (Kvs 5.0).
- Data reading by means of eight-figure LCD display with button on the front of the device.
- Supplied data are split into 7 levels: current energy quantity, cumulative volume, flow and temperature instant values, important technical parameters, heating and cooling monthly values, maximum values.

Performance curves of Energy pump unit and circulating pumps

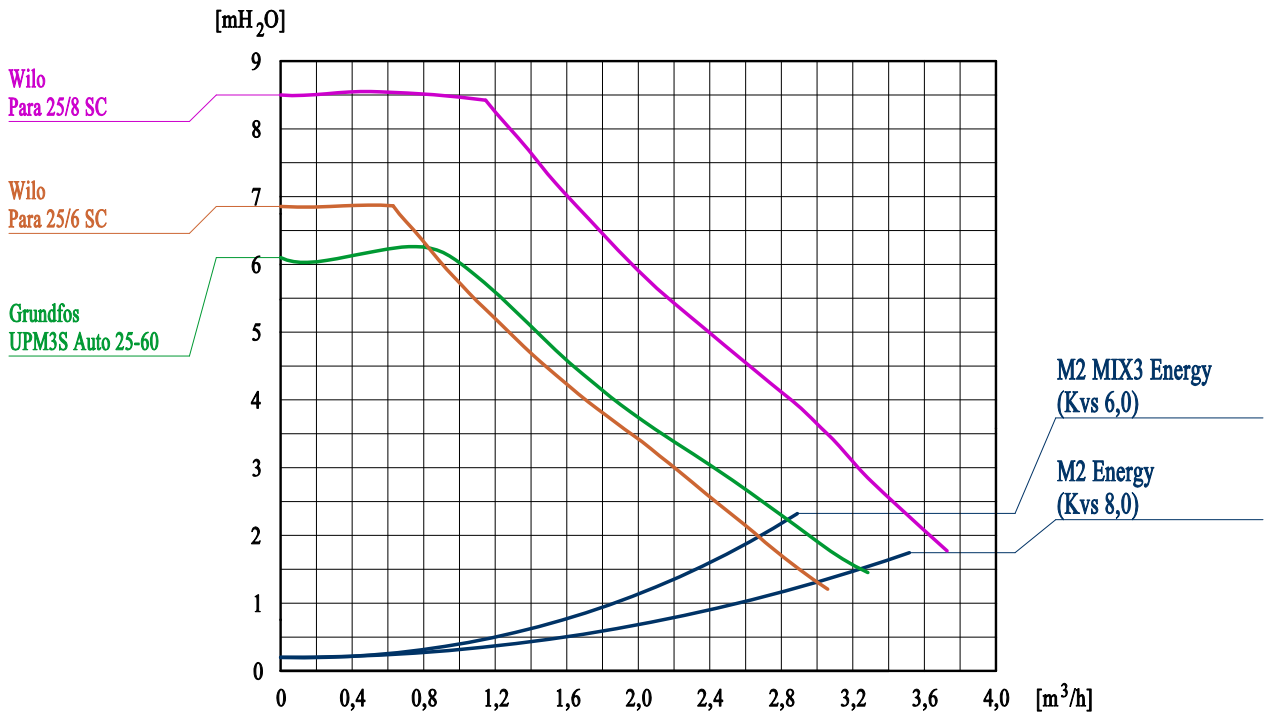

Approximate data of the Energy pump unit with the heat/cooling energy meter installed

Model	Energy meter	Δt	Kvs of the unit (*)	Approximate power and flow rate of the application	Recommended circulating pump	Residual head
M2 + G21	2,5 m ³ /h	20 K	4,2	23 kW - 1000 l/h	Wilo Para 25/6 SC	5,5 mH ₂ O
M2 + G21	2,5 m ³ /h	20 K	4,2	43 kW - 1850 l/h	Wilo Para 25/8 SC	5 mH ₂ O
M2 MIX3 + G21	2,5 m ³ /h	20 K	3,8	23 kW - 1000 l/h	Wilo Para 25/6 SC	5 mH ₂ O
M2 MIX3 + G21	2,5 m ³ /h	20 K	3,8	39 kW - 1700 l/h	Wilo Para 25/8 SC	5 mH ₂ O

(*) The indicated Kvs concerns the unit including the heat/cooling energy meter installed

Kit 518 - Kit for DN15 (Qn 1.5) heat/cooling energy meters

The set consists of:

- 1 pce. Full port ball valve 1/2" F/F made of forged brass with connection M10x1 for the ø5x45 mm temperature sensor. Nickel finish.
- 2 pcs. Full port ball valves 1/2" F x 3/4" nut made of forged brass. Sealable nut. Nickel finish.
- 1 pce. Distance piece DN15 made of plastic, 3/4" threaded connection, 110 mm length.
- Ends threaded to ISO 228 (DIN 259 BSP 2779). Fiber gasket.
- The ball valves are provided with symmetric sealable T handle.

PN 10. Max Temperature 90°C.



Code: 102518

Kit 518 - Kit for DN20 (Qn 2.5) heat/cooling energy meters

The set consists of:

- 1 pce. Full port ball valve 3/4" F/F made of forged brass with connection M10x1 for the ø5x45 mm temperature sensor. Nickel finish.
- 2 pcs. Full port ball valves 3/4" F x 1" nut made of forged brass. Sealable nut. Nickel finish.
- 1 pce. Distance piece DN20 made of plastic, 1" threaded connection, 130 mm length.
- Ends threaded to ISO 228 (DIN 259 BSP 2779). Fiber gasket.
- The ball valves are provided with symmetric sealable T handle.

PN 10. Max Temperature 90°C.



Code: 103518

DN25 PUMP UNITS CONNECTION KIT

Connection kit, supply only, for 1" circulating pumps

The connection kit for 1" circulators is composed of:

Supply

- Flanged ball valve provided with insulation T-handle.
- High efficiency synchronous pre-wired circulating pump (for the models that include it).
- Flanged ball valve supplied with in-handle thermometer (red ring, range 0°C-120°C) and built-in 20 mbar check valve (with deaerator device) with external adjustment control.
- 2 pcs of set 1"1/2 nut and gasket.

PN 10, max temperature 110°C (kit with no pump).

External connections: 1" or 1"1/4 Female.

Code 1": **10321-ISO**
With circulating pump:
10321-ISO-(P6/A6/P8)

Code 1"1/4: **10323-ISO**
With circulating pump:
10323-ISO-(P6/A6/P8)



Available circulating pumps:

- Wilo Para 25/6 SC (P6)
- Grundfos UPM3S Auto 25-60 (A6)
- Wilo Para 25/8 SC (P8)



Connection kit for 1" circulating pumps

The connection kit for 1" circulators is composed of:

Supply

- Flanged ball valve provided with insulation T-handle.
- High efficiency synchronous pre-wired circulating pump (for the models that include it).
- Flanged ball valve supplied with in-handle thermometer (red ring, range 0°C-120°C).
- 2 pcs of set 1"1/2 nut and gasket.

Return

- Flanged ball valve with 20 mbar check valve (which can be excluded by rotating the handle by 45°) supplied with in-handle thermometer (blue ring; 0°C-120°C).
- Set 1"1/2 nut, gasket and male x female adapter.

PN 10, max temperature 110°C (kit with no pump).

External connections: 1" or 1"1/4 Female.

Code 1": **10355-ISO**
With circulating pump:
10355-ISO-(P6/A6/P8)

Code 1"1/4: **10455-ISO**
With circulating pump:
10455-ISO-(P6/A6/P8)



Available circulating pumps:

- Wilo Para 25/6 SC (P6)
- Grundfos UPM3S Auto 25-60 (A6)
- Wilo Para 25/8 SC (P8)



Connection kit for 1" circulating pumps, with by-pass

The connection kit for 1" circulators is composed of:

Supply

- Flanged ball valve provided with insulation T-handle.
- High efficiency synchronous pre-wired circulating pump (for the models that include it).
- Flanged 3-way ball valve supplied with in-handle thermometer (red ring, range 0°C-120°C).
- 2 pcs of set 1"1/2 nut and gasket.

Return

- Flanged 4-way ball valve with 20 mbar check valve (which can be excluded by rotating the handle by 45°) supplied with in-handle thermometer (blue ring; 0°C-120°C).
- Set 1"1/2 nut, gasket and male x female adapter.
- Set by-pass valve 0-0.5 bar and set compression end 22 mm (centre distance 125 mm).

PN 10, max temperature 110°C (kit with no pump).

External connections: 1" or 1"1/4 Female.

Code 1": **10358-ISO**
With circulating pump:
10358-ISO-(P6/A6/P8)

Code 1"1/4: **10458-ISO**
With circulating pump:
10458-ISO-(P6/A6/P8)



Available circulating pumps:

- Wilo Para 25/6 SC (P6)
- Grundfos UPM3S Auto 25-60 (A6)
- Wilo Para 25/8 SC (P8)

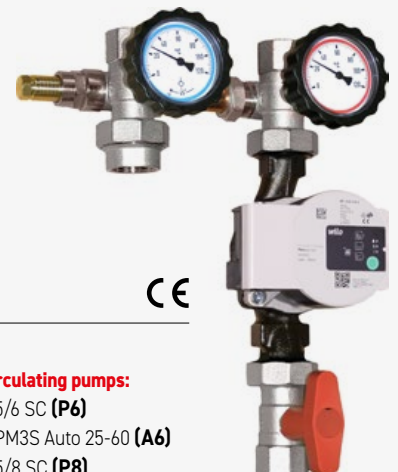

Art. 550S ISO Flanged ball valve

Flanged ball valve in hot forged brass for circulating pumps.
Nickel plate finish.
Provided with insulation T-handle.
Coupling flange for 1" circulating pumps.
Female end threaded to ISO 228 (DIN 259 BSP 2779).
PN 30. Max Temperature 120°C.
Sizes: 1" and 1 1/4.

Code 1": **04550SISO**
Code 1 1/4": **05550SISO**



Model with check-valve - Art. 550S/2 ISO



20 mbar check valve (with deaerator device) with external adjustment control.
PN 10. Max Temperature 110°C.

Code 1": **04550S/2ISO**
Code 1 1/4": **05550S/2ISO**

Art. 550S TER Flanged ball valve with thermometer

Flanged ball valve in hot forged brass for circulating pumps.
Nickel plate finish.
Coupling flange for 1" circulating pumps.
Female end threaded to ISO 228 (DIN 259 BSP 2779).
Supplied with in-handle thermometer, red ring (range 0°C-120°C, TER-R) or
blue ring (range 0°C-120°C, TER-B).
PN 10. Max Temperature 110°C.
Sizes: 1" and 1 1/4.

Code 1": **04550STER-(R/B)**
Code 1 1/4": **05550STER-(R/B)**



Model with check-valve - Art. 550S/2 TER-R



20 mbar check valve (with deaerator device) with external adjustment control.
PN 10. Max Temperature 110°C.

Code 1": **04550S/2TER-R**
Code 1 1/4": **05550S/2TER-R**

Set 1 1/2" nut and fiber gasket

Nickel plate finish.



Code: **AYHU26SET**

Set 1 1/2" nut, fiber gasket and Male x Female (1" or 1 1/4) adapter

Nickel plate finish.



Code 1": **104629**
Code 1 1/4": **104629-05**

Kvs reduction set

The set consists of a plug and an O-ring gasket to join to the art. 1050 to reduce the Kvs of the mixing valve and, consequently, of the pump unit (in the table the model M2 MIX3 is considered) from the standard value to the values indicated in the side column.

Yellow brass finish.

Kvs of mixing valve	Kvs of the unit	Code
10,0 (standard)	6,0 (standard)	-
6,3	5,0	041050SETKVS6.3
4,0	3,5	041050SETKVS.4
2,5	2,4	041050SETKVS2.5



1" Male adapter for copper pipe

The set consists of 1" Male compression fitting, nut and olive. It allows to connect the 1" female pump units to copper pipes of 15, 18, 22 and 28 mm diameter.

Yellow brass finish.

Code 1" Male x 15 mm: **115525**

Code 1" Male x 18 mm: **118525**

Code 1" Male x 22 mm: **122525**

Code 1" Male x 28 mm: **128525**



Set nut 1"1/2 and EPDM gasket

Yellow brass finish.

Code: **AYHT26SET**



Set nut 1"1/2, EPDM gasket and female adapter 1" or 1"1/4"

The 1"1/4 Female model allows the mounting of DN25 pump units on the DN32 zone manifolds (two sets for each pump unit to be installed are required).

Yellow brass finish.

Code 1": **104629F**

Code 1"1/4: **104629F-05**



DN25 wall fixing set

Thanks to the wall fixing set and to the bracket plate it is possible to hold the pump unit at a distance of 100 or 150 mm (between the wall and the axis of pipes).

Insertion dimension: 62 mm.

Centre distance 125 mm.

Threaded connections 1"1/2 Male x 1"1/2 swivel nut.

Code 1": **DAOA25SET**



Set 646R

CONNECTION SET FOR ADDITIONAL COMPONENTS

"T" connection for DN25 pump units. The set allows the side mounting of several additional components such as, for example, sensor holder pit, safety units, filling/draining valve.

The set consists of:

- "T" connection;
- EPDM gasket and union
- Made of brass CW617N. Yellow brass finish.
- Size: 1" Male x 1" F union.

Code: **104646RM**



Examples of possible applications



Connection with safety unit

(code **03647D-3C-4SET**)*, to compensate incidental overpressures of the installation. Bottom end 3/4" male to connect flexible or draining **kit code 103647P**.



Connection with filling/draining ball valve (code **01646R-430SCASET**)*, to make easier filling and draining operations.



Connection with sensor holder pit (**POZ-646-6SET**)*, for the housing of a dip sensor ("TT" series), if the system is equipped with an electronic controller which requires the supply temperature as input.

(*) For all the showed devices, the connection with the "T" connector is allowed by means of a special seal kit with pre-charged EPDM O-Ring that does not need any additional sealant like paste, hemp, ecc.

DN25 PUMP UNITS MAGNETIC FILTER

Art. 652 MAGNETIC FILTER

Function

The magnetic filter is a device that allows to collect sludge and ferrous particles in hydraulic circuits, residues that can compromise the operation of many components such as boilers, synchronous circulating pumps, heat and magnetic meters, etc.

Its particular internal conformation, developed by BRV in its laboratories, exploits some simple principles of physics that allow to create, by pressure difference, an area of calm in the fluid vein where sludge and ferrous particles are deposited, since attracted by a powerful neodymium magnet. These can then be removed easily from the system by acting on the drain valve, an operation that we suggest to repeat at each plant start-up especially in the old ones that are more subject to corrosion and therefore where the concentration of sludge and ferrous particles is higher.

Features

- Compact dimensions combined with very low head losses
- No maintenance or cleaning of the device is required, if not periodic discharge of sludge collected through the drain valve
- Neodymium magnet with attraction force of 4.5 kg and magnet strength 13.000 Gauss
- Simple installation in heating pump units or directly in-line in the circuit (vertical assembly)
- Flow rates up to 5.000 l/h
- Compatible with anti-freeze fluids (glycol ≤ 50%)

PN 10. Maximum temperature 110°C
External connections and Kvs available:
DN25: 1"1/2 x 180 mm - Kvs 21



Possibility of
installation in
heating pump units

Code 1"1/2 Kvs 21: **106652-21**



Conversion kit FOR UNMIXED MODULES

Conversion kit for the installation of the magnetic filter in unmixed modules. It consists of magnetic filter, set nut and gasket, ball valve. The kit must be installed on the return way of the unmixed unit, as shown in the image.

Code: **106652-21-SET**



Installation IN MIXED PUMP UNITS

To install the magnetic filter in mixed units, simply replace the straight fitting of the return.



Insulation insert

For units purchased until July 2020 it will be necessary to order the specific insert for the magnetic filter insulation.

Code: **ISOL-HG**



Unmixed and mixed pump units WITH PREINSTALLED MAGNETIC FILTER

Available model provided with magnetic filter. Unmixed modules (M2) and units with 3-way mixing valve (M2 MIX3/MIX33).

In the product code replace "55R" with "652".

Example: in DN25 units: 20355R-M3 will become 203652-M3.



Inversion of the supply

All pump units are reversible, to realize the supply way on the left side. This operation is simple and quick: in the enclosed directions all the steps are described, even with mixing valves and by-passes. Pump units can be delivered with the left supply from the purchase order (see the price list).



Check valve: Always placed into the neck of the ball valve of the return way. To exclude the check valve, turn the handle by 45° clockwise.

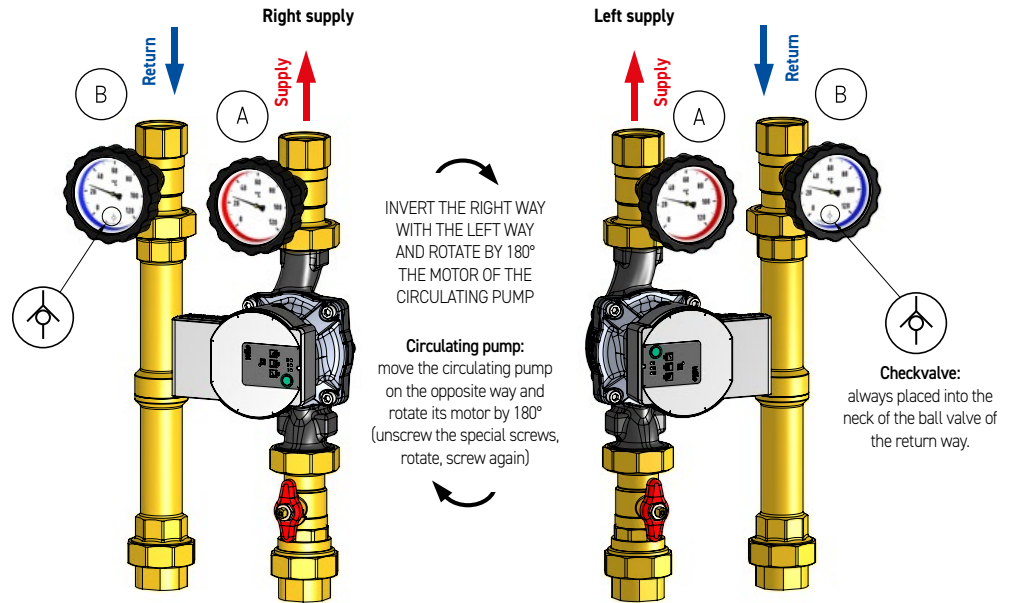

Balancing by-pass valve

The models M3 of the pump units have a by-pass valve mounted into the upper part of the unit, suitable for installations that are working with considerable flow changes, as it happens in the systems that have thermostatic radiator valves or motorized valves. The by-pass enables a flow recirculation proportional to the number of valves that close and it reduces the maximum value of the differential pressure made by the circulating pump. The here below diagram shows a situation in which all the adjustment valves of the circuit are closed. The by-pass (in the example of the position 2) reduces the maximum pressure at 4.75 m of water column. The flow showed is the one that is flowing through the by-pass.

Right supply

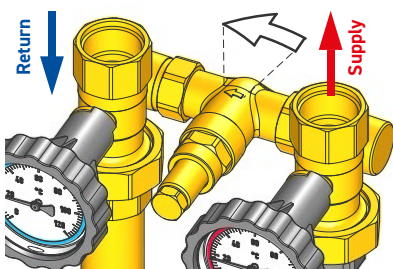

Left supply

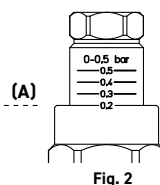
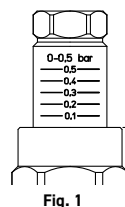
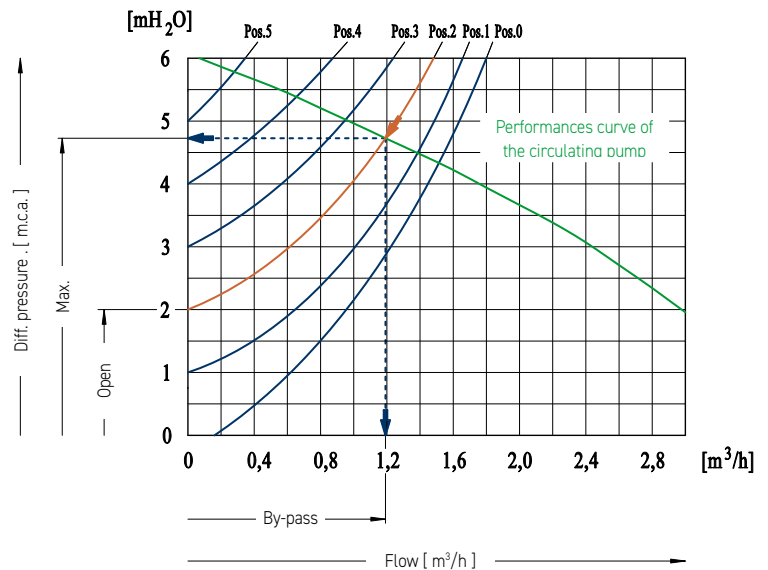
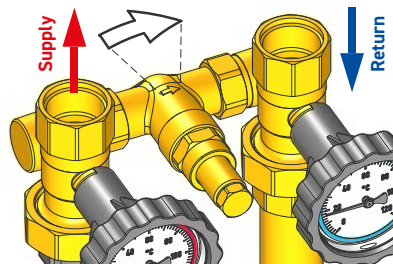

Adjusting of the by-pass

To set the by pass, use the diagram above as a reference.

Fig. 1. The notch reference of the setting is the top of the nut (A).

Fig. 2. Example of the setting at the value of 0.2 bar.

M3 pump units allow a more accurate regulation even in presence of self-controlled electronic pump units.

Method to select the circulating pump

The selection of the right circulating pump is determined by the need to provide the installation with a flow suitable to develop the power fixed in the planning stage. Knowing this datum and taking into consideration the temperature difference Δt between the supply and the return, we can calculate the flow in **kg/h**. It is also important to take into consideration the kind of pump unit that is used, that is known in advance because it has been selected on the basis of the kind of installation to be realized. **Example:** For an installation with a **M2** pump unit that requires a power **P = 50 kW** with a temperature difference **Dt = 20 K** the flow is calculated as follows:

$$\frac{50kW \times 860}{20K} = 2150 \text{ kg/h}$$

Now we have to calculate the total head loss of the installation, to be able to select a circulating pump that is not under-sized. As concerns the pump unit we know the head losses looking to the diagram the curve of the used model. In this case we found that, for the model **M2** with a flow rate of **2150 kg/h (2.15 m³/h)** the head loss is 0.75 m of water column.

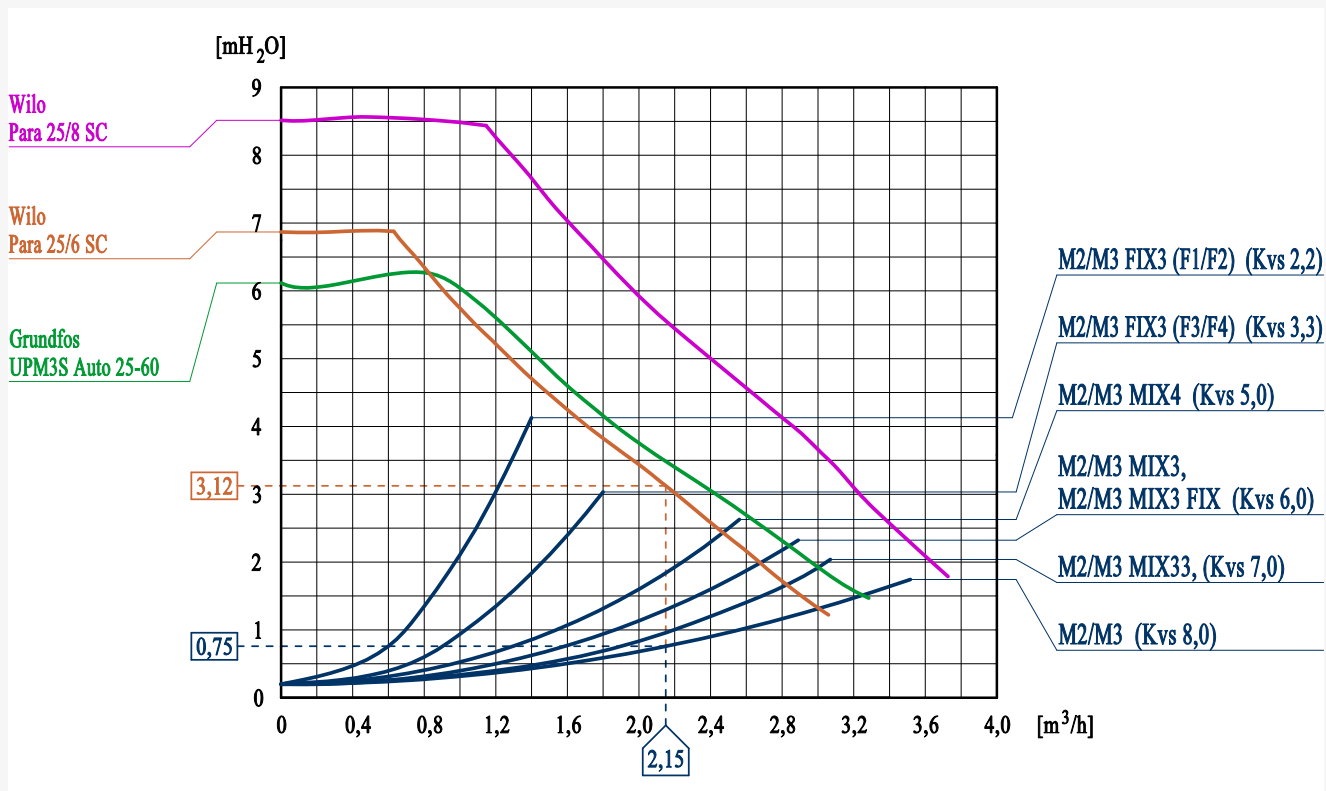

To this head loss we have to add the total head loss of the installation (pipes, connections, radiant elements, etc): this is a datum given by the planner. As we can see from the diagram the circulating pump **Wilo Para 25/6 SC** at a flow rate of **2.15 m³/h** has a head of **3.12 m**.: taking into consideration that the pump unit absorbs **0.75 m** it will left **2.37 m (as 3.12 - 0.75 = 2.37 m)** of water column available to compensate the head losses of the installation. Therefore we have to see if this datum is sufficient, in that case we can use the **Wilo Para 25/6 SC**, otherwise we have to use another circulating pump provided with a bigger head.

NOTE: if necessary it is possible to calculate by a mathematical calculus the head losses (at the required flow rate) produced by the presence of an hydraulic device, if we know its Kvs; therefore, with a good approximation, assuming a standard temperature of 20°C and overlooking the effects of viscosity of the fluid, it follows that:

$$Kvs = \frac{Q}{\sqrt{h}}$$

where the flow **Q** is expressed in m³/h and **h**, the pressure difference at the outlets of the device (head loss), is expressed in bar. Then, reversing the previous formula, we obtain:

$$h = \left(\frac{Q}{Kvs} \right)^2 \quad \text{in the example above:} \quad \left(\frac{2,15}{8} \right)^2 = 0,072 \text{ bar}$$

as 1 bar is about 10.198 mH₂O, then the head loss is 0.73 mH₂O, value that, taking into consideration the approximations, corresponds to the value shown in the diagram.

DN25 Zone manifolds for heating systems made of electro-welded iron pipe with a special zinc-flake coating anticorrosion treatment, suitable for power up to 70 kW.

EPS 25 mm thermic insulation according to DIN 4102-B2 and galvanized steel cover 0.55 mm thickness. Hydraulic test at 12 bar. ModvlvS: connection centre distance 125 mm. The range of zone manifolds is suitable for DN25 1" ModvlvS pump units and DN32 1 1/4"; for the latter you must use the special adapters.

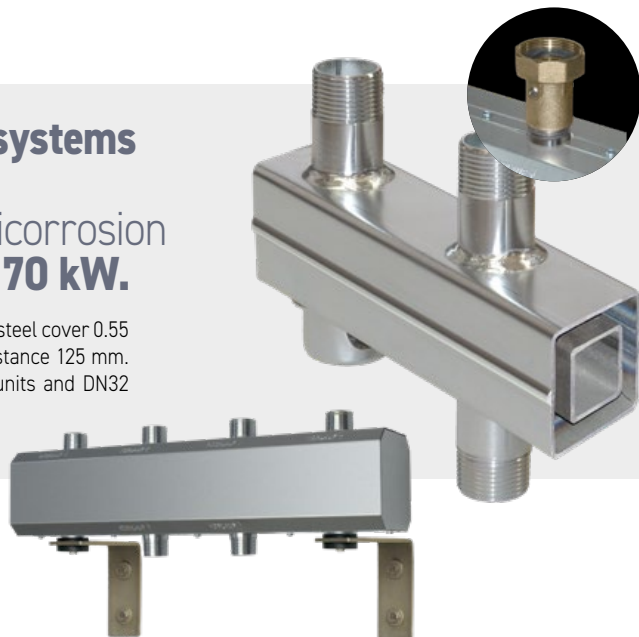

Zone manifold HV 60/125
(2 m³/h - 50 kW)

Zone manifold with insulation suitable for power up to 50 kW (rise in temperature $\Delta T=20$ K in the primary circuit).

Maximum flow rate up to 2 m³/h - Max. 6 bar.
Insulation box section dimensions: 110 x 110 mm.

Connections to the pump units:
1" Male, centre distance 125 mm (pitch 250 mm).

Connection to the hydraulic separator code HW60/125-04 threaded end 1" Male (centre distance 125 mm); for the connection use n. 2 set code **04629SET** (1").

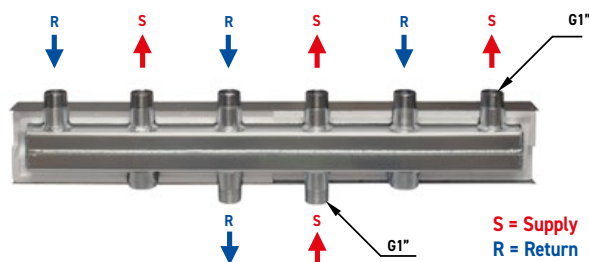

Model	Use	Lenght	Code
HV 60/125-2	For connecting 2 DN25 units	508 mm	HV60/125-2
HV 60/125-3	For connecting 3 DN25 units	758 mm	HV60/125-3

Zone manifold HV 70/125
(3 m³/h - 70 kW)

Zone manifold with insulation suitable for power up to 70 kW (rise in temperature $\Delta T=20$ K in the primary circuit). Side connection 3/4" F for the expansion vessel and/or the draining valve.

Maximum flow rate up to 3 m³/h - Max. 6 bar.
Insulation box section dimensions: 110 x 110 mm.

Connections to the pump units:
1" Male, centre distance 125 mm (pitch 250 mm).

Connection to the hydraulic separator code HW60/125-05 threaded end 1 1/4" Male (centre distance 125 mm); for the connection use n. 2 set code **05629SET** (1 1/4").

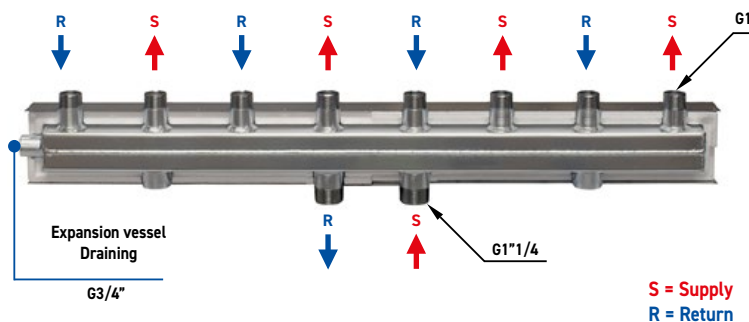

Model	Use	Lenght	Code
HV 70/125-4	For connecting 4 DN25 units	1008 mm	HV70/125-4
HV 70/125-5	For connecting 5 DN25 units	1258 mm	HV70/125-5
HV 70/125-6	For connecting 6 DN25 units	1508 mm	HV70/125-6

Zone manifold HV 60/125 SG (2 m³/h - 50 kW)

Zone manifold with insulation suitable for power up to 50 kW (rise in temperature $\Delta T=20$ K in the primary circuit). 1" male threaded connection for SG50 safety unit. 3/4" female side connection for expansion vessel and/or draining valve.

Maximum flow rate up to 2 m³/h - Max. 6 bar.

Insulation box section dimensions: 110 x 110 mm.

Connections to the pump units:

1" Male, centre distance 125 mm (pitch 250 mm).

Connection to the hydraulic separator code HW60/125-04 threaded end 1" Male (centre distance 125 mm); for the connection use n. 2 set code **04629SET** (1").

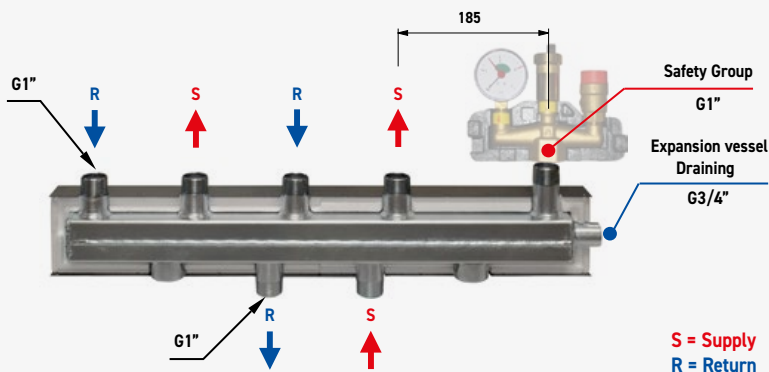

Model	Use	Length	Code
HV 60/125 SG-2	For connecting 2 DN25 units	670 mm	HV60/125SG-2
HV 60/125 SG-3	For connecting 3 DN25 units	920 mm	HV60/125SG-3

Art. 695 - Safety valve

Membrane safety valve for power up to 50 kW. CE marking according to Directive 97/23/CE. TÜV approved. Made to work with water and glycolic fluid.

- Setting pressure: 3 bar.
- Working temperature: from -10°C up to +120°C.

Available sizes: 1/2" x 3/4".

Individual packing code: **02695-03**

Multiple packing code: **02695-030EM**



Adapter connection set for DN32 pump units

The set consists of: 2" nut, EPDM gasket and 1" F connection. It allows the installation of DN32 pump units on the DN25 zone manifolds.

Yellow brass finish.

Two sets are required for each pump unit to be installed.

Code: **105629F-04**



Art. 552

Isolating ball valve 1" Female for 1 1/2" swivel nut in hot forged brass.

Yellow brass finish. Swivel nut and gasket not included.

Ends threaded to ISO 228 (DIN 259 BSP 2779).

Operating stem with allen screw.

PN 6. Max temperature 110°C. DN20.

Code: **0266/M**



Safety unit SG 50

Safety unit for closed circuit heating systems as per EN 12828 regulations with power up to 50 kW.

Brass body, pre-assembled end tested, equipped with selfseal valves to allow an easy replacement of the pressure gauge and of the air-vent valve. It consists of:

- Pressure gauge $\phi 63$, 0-4 bar, 3/8";
- 3/8" automatic air-vent valve. Nominal pressure: 12 bar;
- Safety valve 3 bar 50 kW. Inlet 1/2", outlet 3/4". The PTFE sealing gasket allows the angular repositioning.

EPS insulation box (Dimensions: 187x150x60 mm).

Max Temperature 120°C.

Size: 1" Female.

Code: **SG50**



Wall fixing set for DN20 and DN25 zone manifolds

Pair of brackets to fix to the wall the zone manifold with the insulation box 110 x 110 mm. Distance between the wall and the centre of the zone manifold can be 100 or 150 mm.

Code: **DA0A-COL**



Hydraulic separator HW 60/125

Hydraulic separator with insulation for power up to 70 kW (rise in temperature $\Delta T=20$ K in the primary circuit) to be connected before the zone manifold. This device allows to separate hydraulically the primary circuit from the secondary circuit so giving a greater volumetric flow in the zone manifold in comparison with the flow rate of the boiler.

It is particularly suitable to be mounted with condensing boilers. In fact with a right setting of the boiler pump it ensures a low return water temperature (always lower than 57°C, that is the condensing temperature of the steam in the methane gas) so increasing the efficiency of the installation.

Down connection 1/2" F for the boiler sensor.

Insulation box section dimensions: 110 x 110 mm.

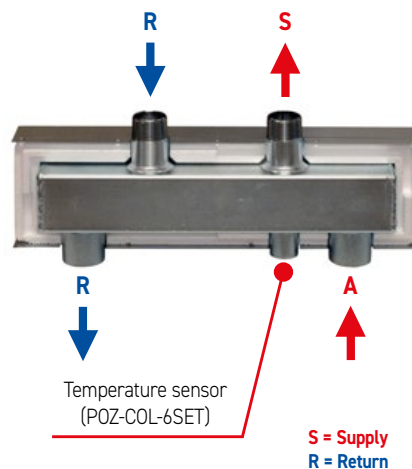

HW 60/125 1"

Code: HW60/125-04

Suitable for flow rate up to 2 m³/h and power up to 50 kW ($\Delta T=20$ K)

Connection to the zone manifold: 1" Male, centre distance 125 mm

Connection to the boiler: 1" Female, centre distance 250 mm

HW 60/125 1"1/4

Code: HW60/125-05

Suitable for flow rate up to 3 m³/h and power up to 70 kW ($\Delta T=20$ K)

Connection to the zone manifold: 1"1/4 Male, centre distance 125 mm

Connection to the boiler: 1"1/4 Female, centre distance 250 mm

Zone manifold: more circulation

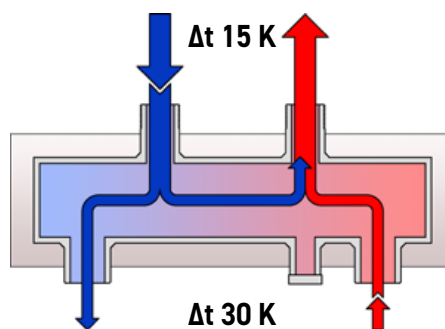

Boiler: less circulation

1/2" adapter with sensor holder pit

1/2" adapter and sensor holder pit $\phi 6$ mm. Equipped with M4 screw to fix the sensor. Thanks to the 1/2" adapter to be sealed to the zone manifold or to the hydraulic separator, the sealing is guaranteed by a special sealing system with precharged EPDM O-ring, that does not need any seal paste, hemp or other sealants.

PN 10. Constant temperature 120°C.

Code: POZ-COL-6SET



Wall fixing set for HW 60 hydraulic separator

Pair of brackets to fix to the wall the hydraulic separator with the insulation box 110 x 110 mm.

Available sizes: 100 and 150 mm (Distance between the wall and the centre of the hydraulic separator).

100 mm: Code: DA0A100

150 mm: Code: DA0A150



Three piece set for connecting the hydraulic separator to the zone manifold

EPDM gasket. Yellow brass finish.

To connect the hydraulic separator to the zone manifold two sets are necessary.

Sizes: 1" F x 1" F; 1"1/4 F x 1"1/4 F.

Code 1": 04629SET

Code 1"1/4: 05629SET



HW series

BUFFER TANKS FOR HEATING & COOLING APPLICATIONS WITH HEAT PUMPS

Buffer tank designed for hydraulic modules

BRV ModvlvS HW buffer tank is designed for cooling applications. In installations with heat pumps it acts as a hydraulic interface and performs the storage function. It allows to limit the number of starts and stops of the heat pump outdoor unit.

BRV ModvlvS HW buffer tank is designed for the installation of two BRV ModvlvS pump units. It can be installed horizontally, to allow quick connection of the primary loop to the heat pump and of the secondary loop to the final user, such as fan convectors or radiant panels, by means of hydraulic modules.

If necessary, the buffer tank can also be installed vertically, as a more frequent case. With this type of installation, a zone manifold must be mounted on the secondary side, if two or more zones are to be managed by means of hydraulic modules. It will be therefore necessary to plug the two unused connections.

The vertical installation of the buffer tank is more complex in terms of pipes and requires the use of a zone manifold. This therefore implies installation costs and a greater number of connections, compared to horizontal installation.



Code for 50 L model, suitable for
DN25 pump units: **HWDN25/125-50**

**Schematics:
buffer tank installed horizontally**

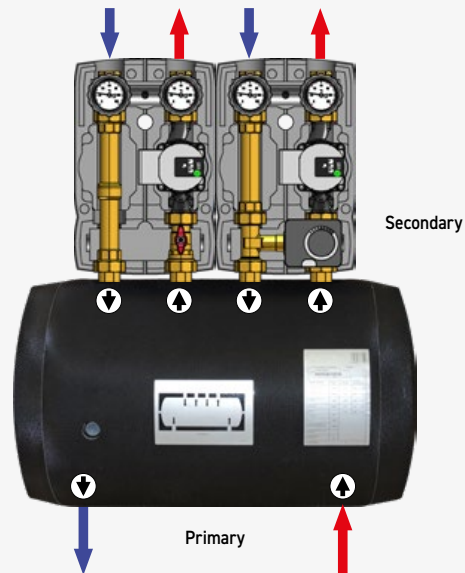

For heating & cooling applications with heat pumps

**Schematics:
buffer tank installed vertically**

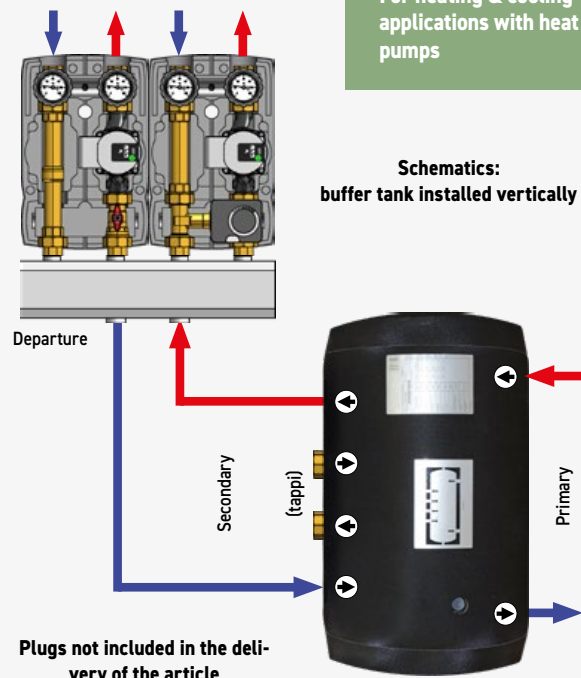

Plugs not included in the delivery of the article

Code	Primary connection	Secondary connection	Pump unit / center distance	Capacity	Working pressure	Max. working temperature	Min. working temperature	Pressure test
HWDN25/125-50	G 1 1/4 F	G 1" F	DN25 - 125 mm	50 L	6 bar	90°C	-10°C	9 bar

HOT & COLD BUFFER TANK FOR HEAT PUMPS

Schematics:

Buffer tank installed horizontally

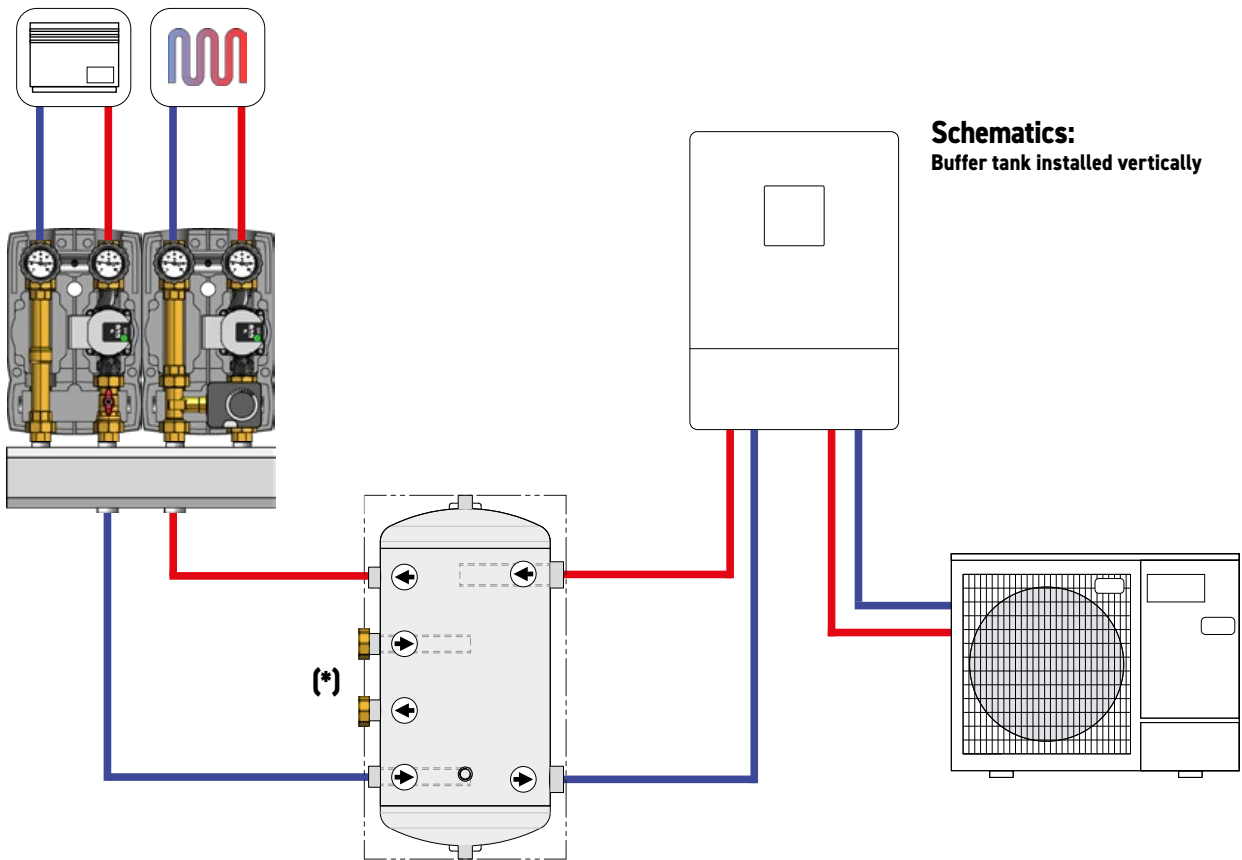
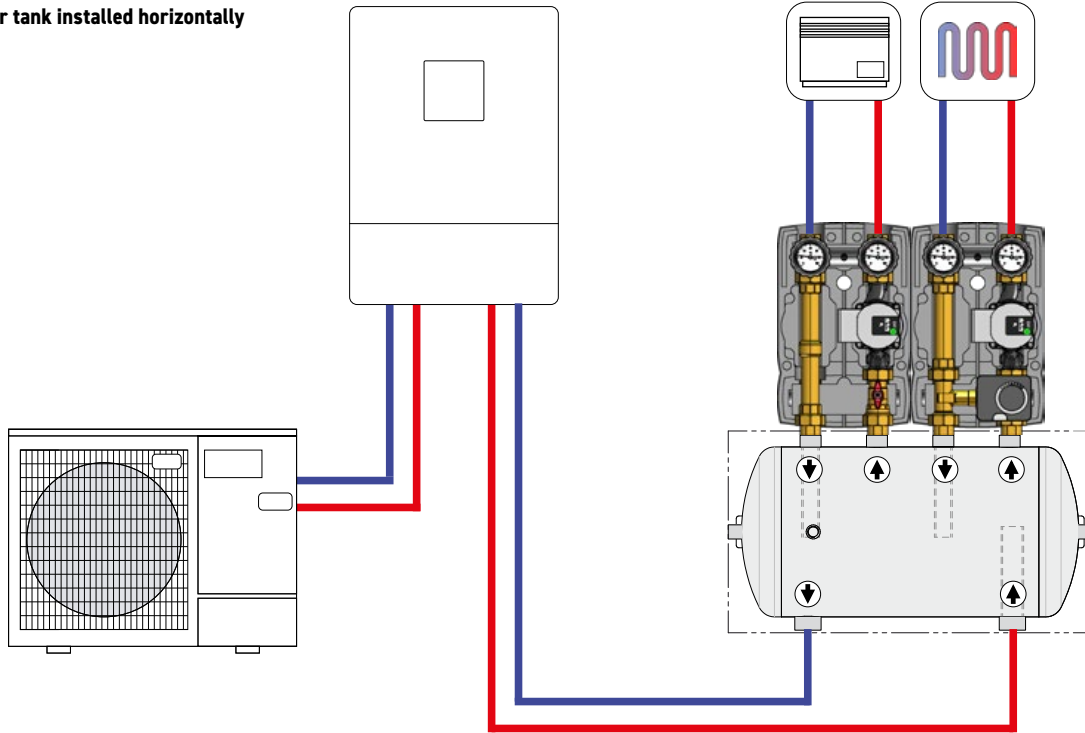

Schematics: Buffer tank installed vertically

(*) For this application, it will be necessary to plug the two unused connections. Plugs not included in the delivery of the article.

Logico

“Logico” is an innovative hydraulic module that allows to control an unmixed and a mixed heating circuit as well as the production of domestic hot water. The particular circulation of the hydraulic fluid inside the module ensures its return to the source of energy at very low temperatures: “Logico”, combined with a condensing boiler, heat pump or solar thermal system, ensures in a simple way the immediate maximum energy efficiency of the complete system.

Logico

COMPACT HYDRAULIC MODULE FOR THE CONTROL OF AN UNMIXED CIRCUIT, A MIXED CIRCUIT AND THE PRODUCTION OF DOMESTIC HOT WATER (DHW)

Logico is easy to install: it is fully assembled and the control unit is already pre-wired. A connecting box facilitates the electrical connections of the external components to the module. The functions of each circuit can be set-up from the room, using a stylish programmable room thermostat (optional) equipped with a capacitive touchscreen.

The heat generator is directly connected to “Logico” and neither zone manifolds, nor hydraulic separators, or additional circulators are necessary. “Logico” works with a single circulating pump.

Further benefits

- Specific isolating valve between primary and secondary allows an easy maintenance for all the components of the group without having to empty the circuit;
- Overpressure balancing valve integrated in the unmixed circuit;
- High efficiency circulating pump with variable Δp and constant Δp to control the differential pressure or control for the constant speed;
- Logico is installed vertically with hydraulic fluid circulation from bottom to top or vice versa; in this case, the control unit can be rotated by 180°.

Centre distance: 90 mm to the circuits; 125 mm to the generator.

EPP insulation box (Dimensions: 400x516x180 mm).

A special back plate allows a quick fitting to the wall.

PN 10, max temperature 95°C.

External connections: 1" Female.

FIELD OF USE

Maximum total power: 35 kW.

Unmixed circuit:

Maximum power of 35 kW (with Δt 20 K) and a maximum flow rate of 1510 l/h. Kvs value: 5.0

Mixed circuit:

Maximum power of 12 kW (with Δt 8 K) and a maximum flow rate of 1300 l/h. Kvs value: 4.0

DHW circuit:

Maximum power of 35 kW (with Δt 15 K) and a maximum flow rate of 2010 l/h. Kvs value: 10.0



Code: **2031052ACS-P6-LH**

Without DHW - Code: **2031052-P6-LH**



°Caleon Smart Room Controller (optional)

Optional room controller °Caleon (for one or two circuits). Stylish TFT capacitive touch panel for easy remote control of the heating system. Normal, Turbo, Eco and Off operation modes with specific temperature setpoint. Holiday program. Up to 8 adjustable daily heating time slot.

Wi-Fi N 2.4 Ghz connection for remote control by °Caleon app



Code: **RC50**



Hydraulic scheme and components

Requirements

The heat source must be equipped with a circulating pump. Otherwise, the "Logico" controller can manage an external circulator, with the support of an additional sensor.

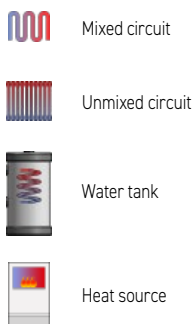
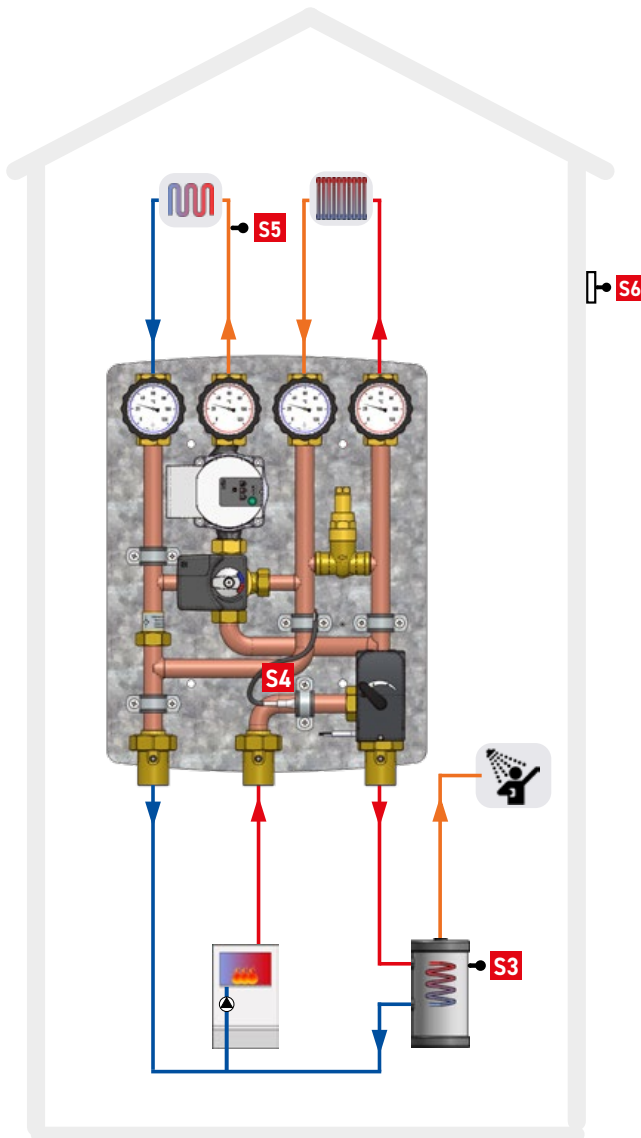

- Sensors:**
- S3** Water tank sensor
 - S4** Supply sensor (unmixed circuit)
 - S5** Mixed circuit sensor
 - S6** Outdoor sensor

Circulating pump Wilo Para 15/6 SC

High efficiency circulating pump with variable Δp and constant Δp to control the differential pressure or control for the constant speed. In compliance with European Directive 2009/125/CE. Low energy consumption from 3 W to 43 W.

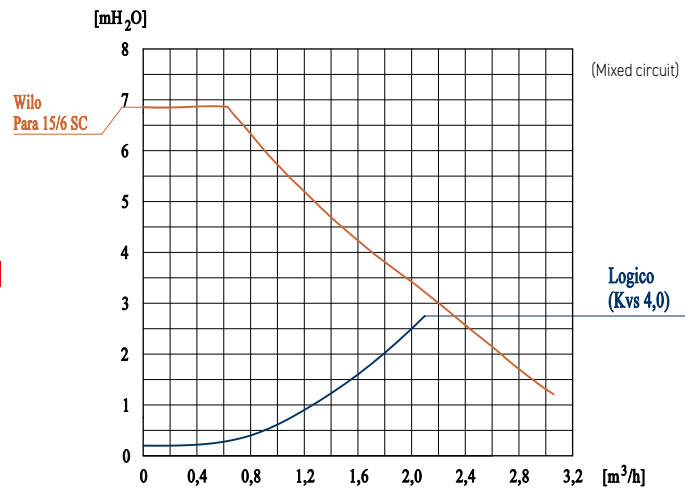

Mixing valve with actuator 3-way mixing valve with dual supply, "Logico" series

Main advantages

- Efficient use of return energy from the unmixed circuit (first supply) or, when needed, directly from the power source (second supply);
- Linear mixing over the entire adjustment range;
- Internal by-pass;
- Very small pressure loss: Kvs 7.0;
- Proportional actuator with 90° working angle. Manual operation selector. A special connector allows the actuator to be replaced in the case of failure or malfunction, without intervening on the electrical wiring.



Logico Climatic Controller

Climatic control unit with a large LCD screen to manage the selected hydraulic system.

- Pictogram of the selected hydraulic system with proof of the state of the relay's activities: circulating pump, mixing valve in opening or closing, diverting valve for DHW and energy demand at source. Two selectable hydraulic systems: with or without DHW management;
- Display sensor temperatures: external, supply calculated and detected for each circuit, room temperature (when °Caleon optional room units are installed). Day or night operation;
- Possibility of controlling a circulating pump, if not available in the heat generator (with an additional sensor, not included: Code TT/P4);
- Adjustment of the temperature curve with a linear or broken slope and related day-night correctors for each circuit;
- Protective function: anti-lock for the circulating pump, anti-freeze control, and minimum or maximum temperature of the supply;
- Up to 3 slots can be set on a daily basis: active heating circuit in day mode or night reduction;
- Optional room unit °Caleon (for one or two circuits)

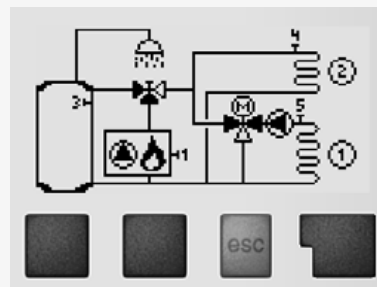

Hydraulic scheme with DHW

HC1	Day	HC2	Day
Tg	32.5°C	Tg	61.5°C
Flow	32.0°C	Flow	62.0°C
Room	20.1°C	Room	20.2°C
Outdoor	4.5°C		
DHW	51.0°C		

Displaying the temperature of the sensors



The control unit is supplied pre-wired with the following sensors (Pt1000):

- Power supply with Schuko plug;
- Circulator control cable with Molex connector;
- Actuator control cables with automat connectors;
- Supply and mixed circuit temperature sensor TR/S0.5;
- Cable with external connecting box for: outside sensor TA/55, DHW water tank sensor TT/P4, boiler contact 0-10V or dry contact;
- °Caleon room unit (optional), power supply 24 VDC (output).

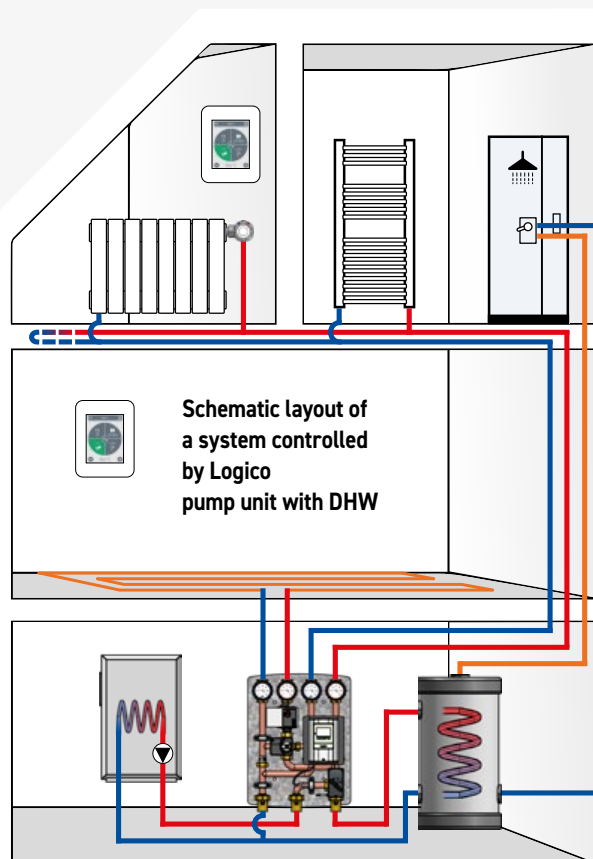

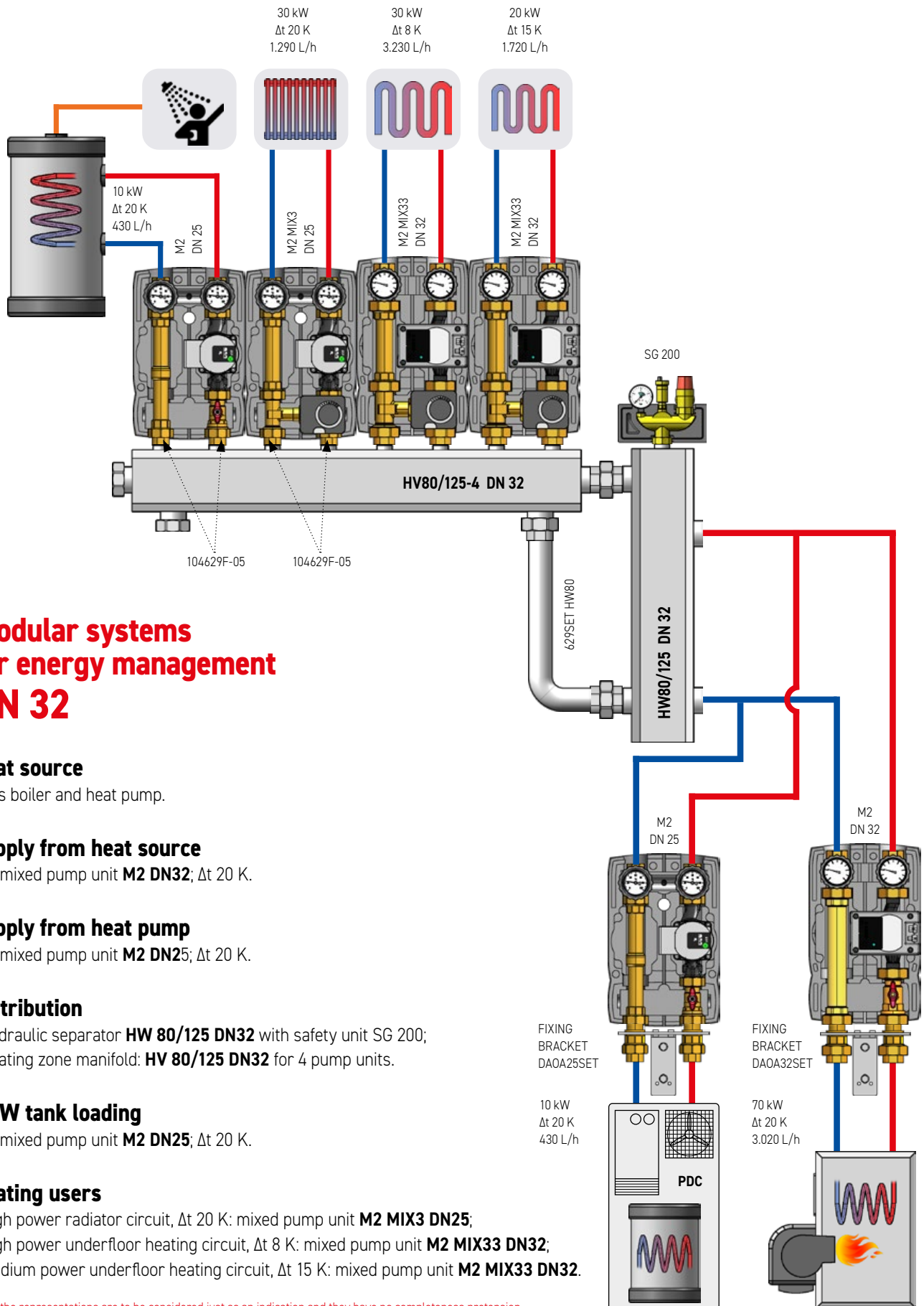

Modular systems for energy management DN 32

Heat source

- Gas boiler and heat pump.

Supply from heat source

- Unmixed pump unit **M2 DN32**; Δt 20 K.

Supply from heat pump

- Unmixed pump unit **M2 DN25**; Δt 20 K.

Distribution

- Hydraulic separator **HW 80/125 DN32** with safety unit SG 200;
- Heating zone manifold: **HV 80/125 DN32** for 4 pump units.

DHW tank loading

- Unmixed pump unit **M2 DN25**; Δt 20 K.

Heating users

- High power radiator circuit, Δt 20 K: mixed pump unit **M2 MIX3 DN25**;
- High power underfloor heating circuit, Δt 8 K: mixed pump unit **M2 MIX33 DN32**;
- Medium power underfloor heating circuit, Δt 15 K: mixed pump unit **M2 MIX33 DN32**.

Note: the representations are to be considered just as an indication and they have no completeness pretension.

ModvlvS DN32

DN32 pump units, thanks to a careful sizing of specific components, maintain all the strengths of ModvlvS range, such as practicality, reliability and versatility of installation. They can be connected to heating systems with powers up to 111 kW, with a very low energy consumption ensured by high efficiency synchronous circulating pumps **Wilo Para and Grundfos Alpha 1**. The connections to the heating loop or to the zone manifold are made with 1"1/4 female thread. The overpressure control is given by the self-controlled circulating pumps which, thanks to the integrated control of the differential pressure at constant Δp or variable Δp , allow to equalize the performances and the efficiency of M3 pump units of DN25 series even in presence of very high flow rates (up to 4800 l/h). In the diagram at side you can see the performance curves of **Wilo Para Maxo 30-180-08** circulating pump in the available working modes.

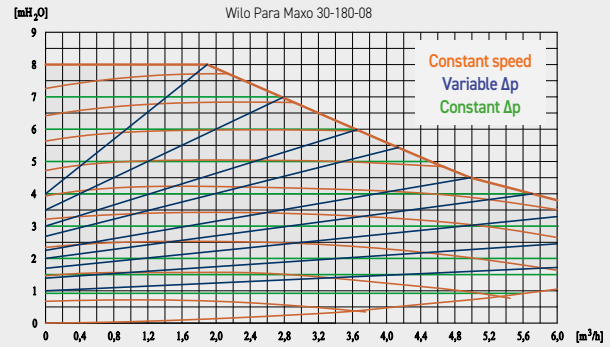

M2 2-WAY UNMIXED PUMP UNIT

The unit for 1"1/4 (180 mm) circulating pumps consists of:

Supply

- Connection.
- Flanged ball valve with T-handle.
- High efficiency synchronous pre-wired circulating pump (for the models that include it).
- Flanged ball valve supplied with in-handle thermometer (red ring, range 0°C-120°C).

Return

- Flanged ball valve supplied with in-handle thermometer (blue ring; range 0°C-120°C).
- Connection or magnetic filter and ball valve (in the models where it is present); integrated 20 mbar check valve.
- Connection.

Centre distance 125 mm.

EPP insulation box (Dimensions: 250x400x170 mm).

PN 10, max temperature 110°C (unit without pump).

External connections: 1"1/4 Female.

FIELD OF USE

For power up to 111 kW (with Δt 20 K) and maximum flow rate 4800 l/h.

Kvs Value: 21.0.

Approximate data calculated with a 8 m head circulating pump (Wilo Para Maxo 30-180-08). For an accurate sizing or for higher flow rates, please refer to the diagram.

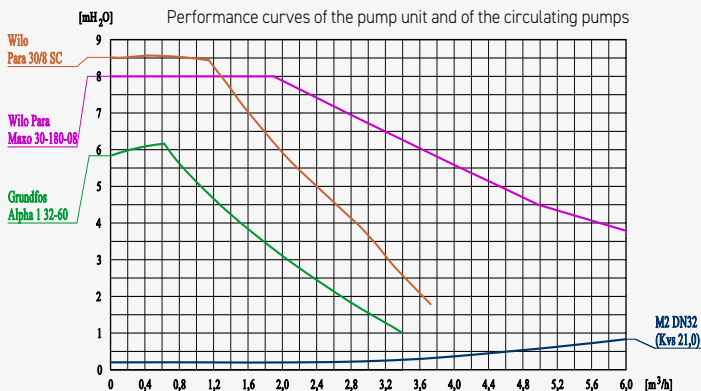

Standard version: right supply. Left supply version available with extra price: look at price list.



Code 1"1/4: **20555R**

With circulating pump: **20555R-(A6/PA1-7/PA1-8)**

With magnetic filter: Code 1"1/4: **20565Z**

With circulating pump: **20565Z-(A6/PA1-7/PA1-8)**



Available circulating pumps:

Grundfos Alpha 1 32-60 (**A6**)

Wilo Para 30/8 SC (**PA1-7**)

Wilo Para Maxo 30-180-08 (**PA1-8**)



Available model provided with magnetic filter



Available model provided with integrated magnetic filter



DN32 PUMP UNITS

3-WAY MIXED

M2 MIX3

2-WAY PUMP UNIT WITH 3-WAY MIXING VALVE

The unit for 1 1/4 (180 mm) circulating pumps consists of:

Supply

- Connection.
- 3-way mixing valve.
- High efficiency synchronous pre-wired circulating pump (for the models that include it).
- Flanged ball valve supplied with in-handle thermometer (red ring, range 0°C-120°C).

Return

- Flanged ball valve supplied with in-handle thermometer (blue ring; range 0°C-120°C).
- Connection or magnetic filter (in the models where it is present) with 20 mbar check valve
- "T" Connection for mixing valve.
- Connection.

Centre distance 125 mm.

EPP insulation box (Dimensions: 250x400x170 mm).

PN 10, max temperature 110°C (unit without pump).

External connections: 1 1/4 Female.

FIELD OF USE

For power up to 93 kW (with Δt 20 K) and maximum flow rate 4000 l/h.
Kvs Value: 13.0.

Approximate data calculated with a 8 m head circulating pump (Wilo Para Maxo 30-180-08). For an accurate sizing or for higher flow rates, please refer to the diagram.



It is recommended to install two isolating valves **Art. 552** (see the section "DN32 Zone manifolds") with nut and gasket before the pump unit to allow an easy service or replacement of the components of the unit.

Code 1 1/4: **05552/M**



Optional check valve

Check valve to be installed into the connection of the mixing valve on the return way. It prevents back flow rate of energy in presence of complex installations (e.g. different circulating pumps and/or several mixing valves on the zone manifold). Minimum opening pressure: 20 mbar. Kvs 25.0. Max Temperature 110°C.

Code: **CRKZOV32**



Code 1 1/4: **20555R-M3**

With circulating pump: **20555R-M3-(A6/PA1-7/PA1-8)**

With magnetic filter: Code 1 1/4: **205652-M3**

With circulating pump: **205652-M3-(A6/PA1-7/PA1-8)**



Available circulating pumps:

Grundfos Alpha 1 32-60 (**A6**)

Wilo Para 30/8 SC (**PA1-7**)

Wilo Para Maxo 30-180-08 (**PA1-8**)



Available model

provided with magnetic filter

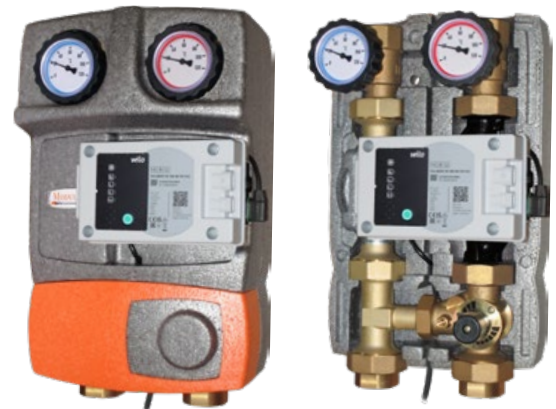

M21D



Model with built-in actuator or climatic controller

M21D: 3 point actuator for mixing valve. Bidirectional, reversible with fixed limit switches for an operating range of 90°, 2 min., torque: 5 Nm. Power supply 230V. IP42.

AHD20



AHD20: Actuator with climatic controller and outside sensor. Optional room sensor. Bidirectional, reversible with fixed limit switches for an operating range of 90°, torque: 6 Nm. Power supply 230V. IP42.

Note: in units with pre-assembled pump, the pumps Wilo Para 30/8 SC and Wilo Para Maxo 30-180-08 are respectively identified in the code with P7 and P8.

Code 1 1/4: **20555R-M3-(M21/AHC)**

With circulating pump:

20555R-M3-(A6/P7/P8)-(M21/AHC)

Available versions with reduced Kvs (using the special sets, see section "DN32 Equipments and accessories"). In the table below the resulting Kvs of the unit is shown, with the relevant maximum values of power and flowrate.

Mixing valve Kvs	Pump unit Kvs	Power	Flow rate
16,0 (std.)	13,0 (std.)	93 kW	4000 l/h
12,5	11,0	79 kW	3400 l/h
10,0	9,0	64 kW	2750 l/h
6,3	6,0	43 kW	1850 l/h

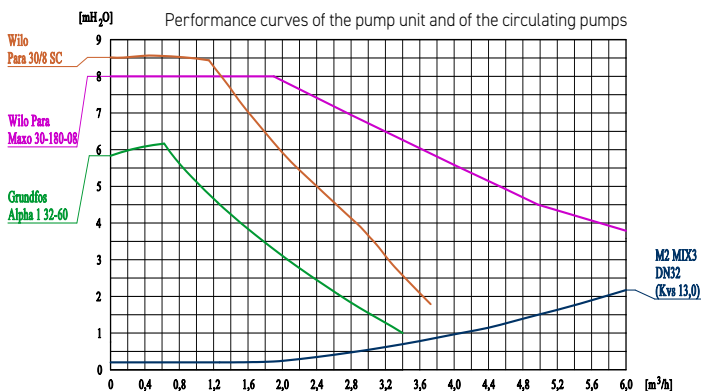

Standard version: right supply. Left supply version available with extra price: look at price list.

DN32 PUMP UNITS

3-WAY MIXED

LOW TEMPERATURE

M2 MIX33

2-WAY PUMP UNIT WITH 3-WAY MIXING VALVE WITH BUILT-IN BY-PASS

The unit for 1 1/4 (180 mm) circulating pumps consists of:

Supply

- Connection.
- 3-way mixing valve with adjustable by-pass. Through the by-pass (adjustable from the front part) it is possible to mix on the supply line a quantity of water coming back from the return line of the system.
- High efficiency synchronous pre-wired circulating pump (for the models that include it).
- Flanged ball valve supplied with in-handle thermometer (red ring, range 0°C-120°C).

Return

- Flanged ball valve supplied with in-handle thermometer (blue ring; range 0°C-120°C).
- Connection or magnetic filter (in the models where it is present) with 20 mbar check valve
- "T" Connection for mixing valve.
- Connection.

Centre distance 125 mm.

EPP insulation box (Dimensions: 250x400x170 mm).

PN 10, max temperature 110°C (unit without pump).

External connections: 1 1/4 Female.

FIELD OF USE

For power up to 76 kW (with Δt 15 K) and maximum flow rate 4400 l/h. Kvs Value: 16.0.

Approximate data calculated with a 8 m head circulating pump (Wilo Para Maxo 30-180-08). For an accurate sizing or for higher flow rates, please refer to the curve.



Code 1 1/4: **20555R-M33**

With circulating pump: **20555R-M33-(A6/PA1-7/PA1-8)**

With magnetic filter: Code 1 1/4: **205652-M33**

With circulating pump: **205652-M33-(A6/PA1-7/PA1-8)**



Available circulating pumps:

Grundfos Alpha 1 32-60 **(A6)**

Wilo Para 30/8 SC **(PA1-7)**

Wilo Para Maxo 30-180-08 **(PA1-8)**



Available model provided with magnetic filter



It is recommended to install two isolating valves **Art. 552** (see the section "DN32 Zone manifolds") with nut and gasket before the pump unit to allow an easy service or replacement of the components of the unit.

Code 1 1/4: **05552/M**



Optional check valve

Check valve to be installed into the connection of the mixing valve on the return way. It prevents back flow rate of energy in presence of complex installations (e.g. different circulating pumps and/or several mixing valves on the zone manifold). Minimum opening pressure: 20 mbar. Kvs 25.0. Max Temperature 110°C.

Code: **CRKZOV32**



Integrated by-pass

The by-pass integrated into the 3-way mixing valve ensures a recirculation inside the installation, even when the mixing valve is fully open. Through the by-pass, a fixed percent of the mixing can be set, in the case when the flow through the mixing valve is not sufficient. In case of a bad working of the system causing an increase of the temperature of the installation, the recirculation through the by-pass allows a decrease of the water temperature in the underfloor installation, by mixing the warm water of the return circuit with the hot water of the supply circuit, reducing possible damages.

M2 MIX33 pump units are supplied with the recirculation by-pass fully open.

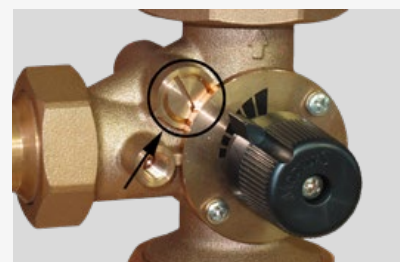

Approximate data for applications in low and medium temperature heating systems

Δt	Approximate power and flow rate of the application	Recommended circulating pump	Residual head	Approximate surface of the underfloor heating system
8 K	19 kW - 2000 l/h	Wilo Para 30/8 SC	6 mH ₂ O	Up to 250 m ²
8 K	26 kW - 2800 l/h	Wilo Para Maxo 30-180-08	7 mH ₂ O	Up to 300 m ²
15 K	42 kW - 2400 l/h	Wilo Para 30/8 SC	5 mH ₂ O	-
15 K	76 kW - 4400 l/h	Wilo Para Maxo 30-180-08	5 mH ₂ O	-

Operating principle

During normal operation, for example with the mixer completely closed on the recirculation, a part of the fluid is sucked by the pump all along the by-pass line. As a result, a very high user flow rate is obtained at a reduced temperature.

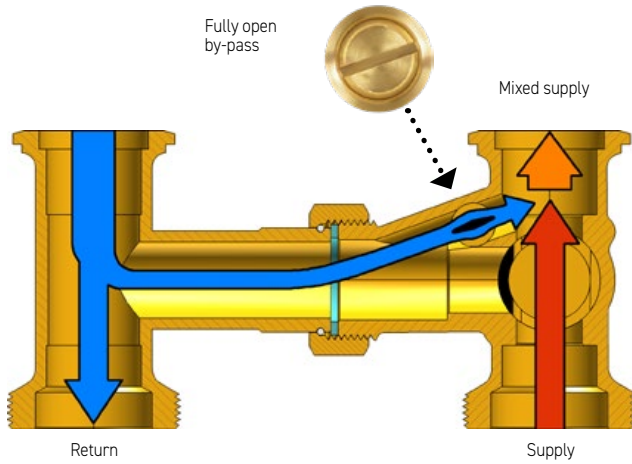

Adjusting the by-pass

The by-pass is **fully open** and it allows the maximum recirculation. The screwdriver cut is aligned along the reference indicator.

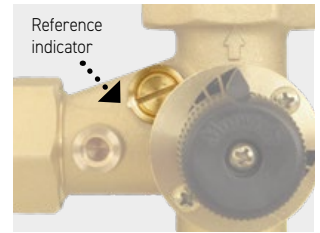

The by-pass is **fully closed** and there is no recirculation. The screwdriver cut is in an orthogonal position (at 90°) in comparison with the reference indicator.

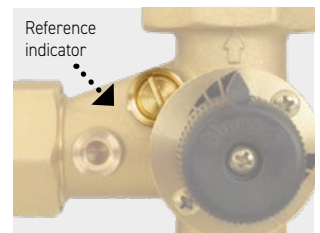

HEATING AND COOLING

Model with built-in actuator or climatic controller

M21D



M21D: 3 point actuator for mixing valve. Bidirectional, reversible with fixed limit switches for an operating range of 90°, 2 min., torque: 5 Nm. Power supply 230V. IP42.

AHD20



AHD20: Actuator with climatic controller and outside sensor. Optional room sensor. Bidirectional, reversible with fixed limit switches for an operating range of 90°, torque: 6 Nm. Power supply 230V. IP42.

Note: in units with pre-assembled pump, the pumps Wilo Para 30/8 SC and Wilo Para Maxo 30-180-08 are respectively identified in the code with P7 and P8.

Code 1"1/4: **20555R-M33-(M21/AHC)**

With circulating pump: **20555R-M33-(A6/P7/P8)(M21/AHC)**

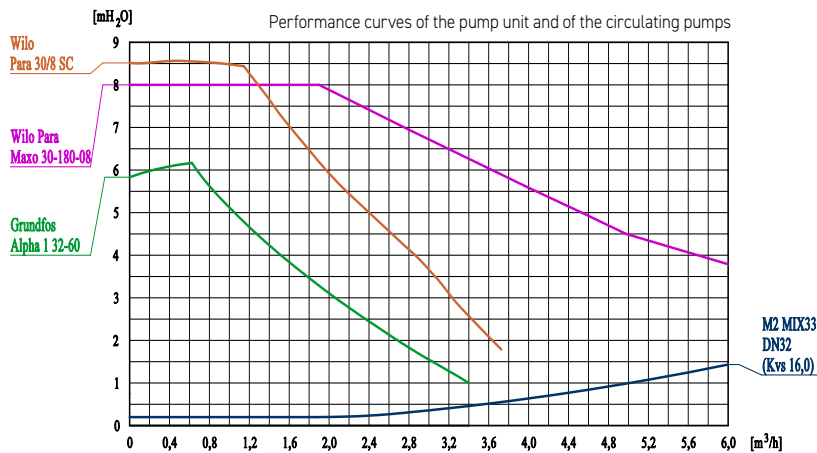

Standard version: right supply. Left supply version available with extra price: look at price list.

DN32 PUMP UNITS FIXED TEMPERATURE HIGH POWER

M2 MIX3 FIX

2-WAY PUMP UNIT WITH 3-WAY MIXING VALVE WITH ELECTRONIC CONTROL FOR CONSTANT TEMPERATURE. HEATING AND COOLING

The unit for 1"1/4 (180 mm) circulating pumps consists of:

Supply

- Connection.
- 3-way mixing valve with electronic actuator.
- High efficiency synchronous pre-wired circulating pump (for the models that include it).
- Flanged ball valve supplied with in-handle thermometer (red ring, range 0°C-120°C).
- Temperature sensor.
- Bimetallic unipolar thermostat, 20÷90°C, with contact by interruption or switching.

Return

- Flanged ball valve supplied with in-handle thermometer (blue ring; range 0°C-120°C).
- Connection with 20 mbar check valve
- "T" Connection for mixing valve.
- Connection.

Centre distance 125 mm.

EPP insulation box (Dimensions: 250x400x170 mm).

PN 10, max temperature 110°C (unit without pump).

External connections: 1"1/4 Female.

FIELD OF USE

For power up to 93 kW (with Δt 20 K) and maximum flow rate 4000 l/h. Kvs Value: 13.0.

Approximate data calculated with a 8 m head circulating pump (Wilo Para Maxo 30-180-08). For an accurate sizing or for higher flow rates, please refer to the curve.

It is recommended to install two isolating valves **Art. 552** (see the section "DN32 Zone manifolds") with nut and gasket before the pump unit to allow an easy service or replacement of the components of the unit.

Code 1"1/4: **05552/M**



Code 1"1/4: **20555R-M3F-CT**

With circulating pump: **20555R-M3F-(A6/P7/P8)-CT**



Available circulating pumps:

Grundfos Alpha 1 32-60 **(A6)**

Wilo Para 30/8 SC **(P7)**

Wilo Para Maxo 30-180-08 **(P8)**



The electronics of the actuator keeps constant the set temperature of the supply way, monitoring it by means of a sensor (included) mounted on the pipe. Display of the measured temperature and target temperature, on reversible LCD display.



Setting of target temperature adjustable from 5°C up to 90°C. Operating range of 90°. Power supply 230V, torque 6 Nm. IP42.

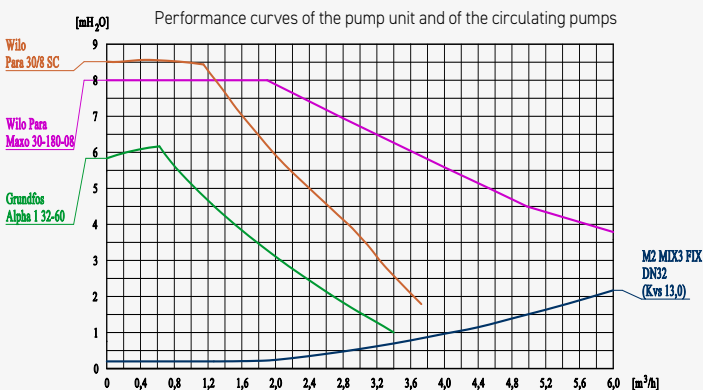

Standard version: right supply. Left supply version available with extra price: look at price list.

Optional check valve

Check valve to be installed into the connection of the mixing valve on the return way. It prevents back flow rate of energy in presence of complex installations (e.g. different circulating pumps and/or several mixing valves on the zone manifold). Minimum opening pressure: 20 mbar. Kvs 25.0. Max Temperature 110°C.



Code: **CRKZOV32**

Kvs reduction set

The set consists of a plug and of an O-ring gasket to join to the art. 1050 to reduce the Kvs of the mixing valve and, consequently, of the pump unit (on the table the model M2 MIX3 is considered) from the standard value to the values indicated in the side column. Yellow brass finish.

Kvs of mixing valve	Kvs of pump unit	Code
16,0 (standard)	13,0 (standard)	-
12,5	11,0	051050SETKVS12.5
10,0	9,0	051050SETKVS10
6,3	6,0	051050SETKVS6.3



Set 2" nut and EPDM gasket

Yellow brass finish



Code: **AYHT07SET**

Set 2" nut, EPDM gasket and female adapter 1"1/4 or 1"

The version 1" female allows to install the DN32 pump units on the DN25 zone manifolds (for the mounting, two kits for each unit are needed). Yellow brass finish



Code 1"1/4: **105629F**
Code 1": **105629F-04**

Art. 670 Set Connection set for heat/cooling energy meter

The set allows the housing of a heat/cooling energy meter (not included) into the return way of M2 pump units. Distant piece made of plastic with brass threaded ends 2", suitable for DN20 meters. Check valve housed in the lower connection.

Code DN20, distant piece 1" 130 mm length: **04670SET-DN32**

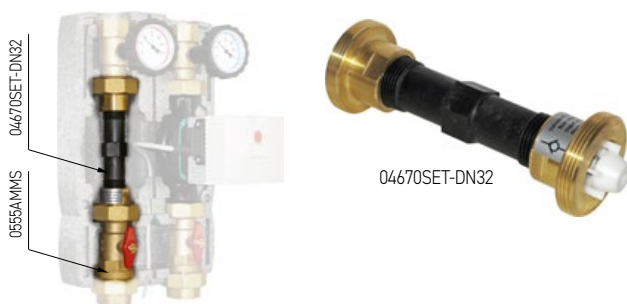

DN32 wall fixing set

Thanks to the wall fixing set and to the bracket plate it is possible to hold the pump unit at a distance of 160 between the wall and the axis of pipes.

Insertion dimension: 62 mm.
Centre distance 125 mm.
Threaded connections 2" Male x 2" swivel nut.

Code: **DA0A32SET**



Art. 55AMMS - Flanged ball valve

Flanged ball valve in hot forged brass for circulating pumps. Yellow brass finish. Provided with steel T-handle. Coupling flange for 1"1/4 circulating pumps. Male end threaded to ISO 228 (DIN 259 BSP 2779). 2" nut and gasket not included.

PN 30. Max Temperature 120°C.
Size: 2" Male x 2" Nut.

Code: **0555AMMS**



Art. 652 MAGNETIC FILTER

Function

The magnetic filter is a device that allows to collect sludge and ferrous particles in hydraulic circuits, residues that can compromise the operation of many components such as boilers, synchronous circulating pumps, heat and magnetic meters, etc.

Its particular internal conformation, developed by BRV in its laboratories, exploits some simple principles of physics that allow to create, by pressure difference, an area of calm in the fluid vein where sludge and ferrous particles are deposited, since attracted by a powerful neodymium magnet. These can then be removed easily from the system by acting on the drain valve, an operation that we suggest to repeat at each plant start-up especially in the old ones that are more subject to corrosion and therefore where the concentration of sludge and ferrous particles is higher.

Features

- Compact dimensions combined with very low head losses
- No maintenance or cleaning of the device is required, if not periodic discharge of sludge collected through the drain valve
- Neodymium magnet with attraction force of 4.5 kg and magnet strength 13.000 Gauss
- Simple installation in heating pump units or directly in-line in the circuit (vertical assembly)
- Flow rates up to 5.000 l/h
- Compatible with anti-freeze fluids (glycol ≤ 50%)

PN 10. Maximum temperature 110°C
External connections and Kvs available:
DN32: 2"x180mm-Kvs21



Possibility of installation in heating pump units

Code: **107652-21**



Conversion kit FOR UNMIXED MODULES

Conversion kit for the installation of the magnetic filter in unmixed modules. It consists of magnetic filter, set nut and gasket, ball valve. The kit must be installed on the return way of the unmixed unit, as shown in the image.

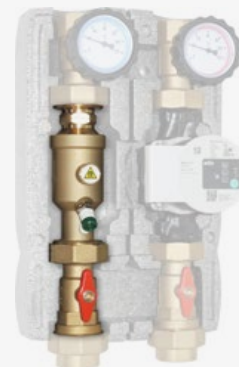

Code: **107652-21-SET**

Installation IN MIXED PUMP UNITS

To install the magnetic filter in mixed units, simply replace the straight fitting of the return.



For DN32 groups it is also necessary to purchase the check valve which must be inserted in the special seat in magnetic filter.

Code: **CRKZOV32**

Insulation insert

For DN25 and DN32 units purchased until July 2020 it will be necessary to order the specific insert for the magnetic filter insulation.



Code: **ISOL-HG05**

Unmixed and mixed pump units WITH PREINSTALLED MAGNETIC FILTER

Available model provided with magnetic filter. Unmixed modules (M2) and units with 3-way mixing valve (M2 MIX3/MIX33).

In the product code replace "55R" with "652". E.g.: 20555R-M3 will become 205652-M3.



DN32 zone manifolds for heating systems made of electro-welded iron pipe with a special zinc-flake coating anticorrosion treatment, suitable for power up to 165 kW.

EPS 35 mm thermic insulation according to DIN 4102-B2 and galvanized steel cover 0.8 mm thickness. Hydraulic test at 12 bar. ModvlvS: connection centre distance 125 mm. The range of zone manifolds is suitable for DN32 1"1/4 ModvlvS pump units and DN25 1"; for the latter you must use the special adapters.



Zone manifold HV 80/125 (7,25 m³/h - 165 kW)

Zone manifold with insulation suitable for power up to 165 kW (rise in temperature $\Delta T = 20$ K in the primary circuit). The double connection supply/return allows the installation of the hydraulic separator both on the left and on the right side: in this way you can avoid to rotate the zone manifold and to reverse the supply and return pipes towards the user. Moreover the two plugs made of galvanized cast iron, 2" female threaded, required to isolate the two unused connections of the zone manifold are also included.

Maximum flow rate up to 7.25 m³/h - Max. 6 bar
Insulation box section dimensions: 152x152 mm.

Connections to the pump units
1"1/4 Male, centre distance 125 mm (pitch 250 mm).

Connection to the hydraulic separator code HW80/570-07 threaded end 2" Male; to make the connection please use the set code 07629HW80 (2") that includes the required components.

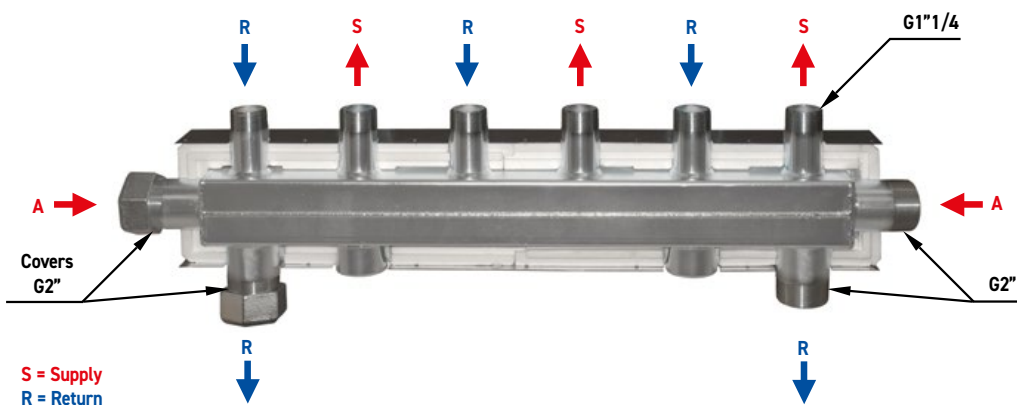
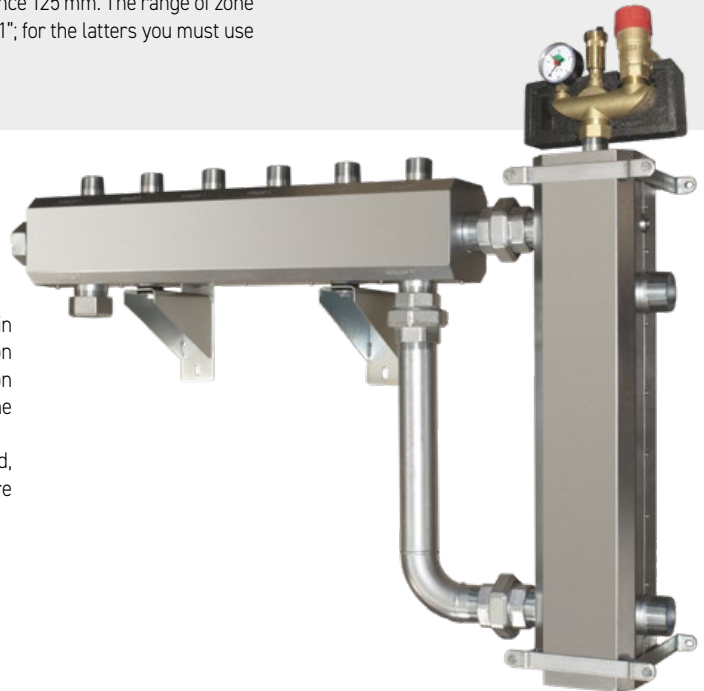

Model	Use	Length	Code
HV 80/125-2	For connecting 2 DN32 units	625 mm	HV80/125-2-M8
HV 80/125-3	For connecting 3 DN32 units	875 mm	HV80/125-3-M8
HV 80/125-4	For connecting 4 DN32 units	1125 mm	HV80/125-4-M8
HV 80/125-5	For connecting 5 DN32 units	1375 mm	HV80/125-5-M8
HV 80/125-6	For connecting 6 DN32 units	1625 mm	HV80/125-6-M8

Wall fixing set for DN32 zone manifolds

Pair of brackets to fix to the wall the zone manifold with the insulation box 152x152 mm. Distance between the wall and the centre of the zone manifold: 160 mm.



Code: **DA0A-HV160-M8**

Hydraulic separator HW 80/125

Hydraulic separator with insulation for power up to 165 kW (rise in temperature $\Delta T=20$ K in the primary circuit), to be connected before the HV 80 zone manifold. This device allows to separate hydraulically the primary circuit from the secondary circuit so giving a greater volumetric flow in the zone manifold in comparison with the flow rate of the boiler. It is particularly suitable to be mounted with condensing boilers. In fact with a right setting of the boiler pump it ensures a low return water temperature (always lower than 57°C, that is the condensing temperature of the steam in the methane gas) so increasing the efficiency of the system.

Maximum flow rate up to 7.25 m³/h - Max 6 bar.

Insulation box section size: 152x152 mm.

In the upper part, 1"1/4 male connection for safety unit.

1/2" female connection for drain (in the lower part) and temperature sensor (located laterally).

Code: **HW80/570-07**

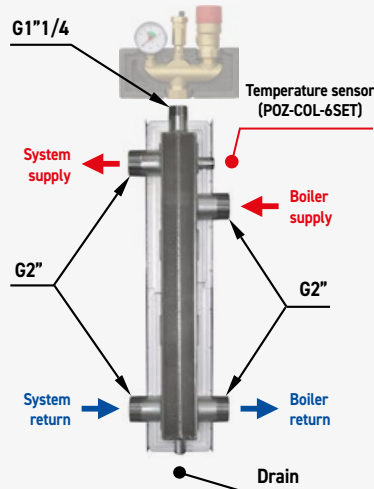

Art. 552

Isolating ball valve 1"1/4 Female for 2" swivel nut in hot forged brass. Yellow brass finish. 2" swivel nut and gasket not included. Ends threaded to ISO 228 (DIN 259 BSP 2779). Operating stem with allen screw.

PN 6. Max temperature 95°C. DN25.

Code: **0552/M**

Safety Unit SG 200

Safety unit for closed circuit heating systems as per EN 12828 regulations with power up to 200 kW. Brass body, pre-assembled end tested, equipped with selfseal valve to allow an easy replacement of the air-vent valve. It consists of:

- Pressure gauge $\phi 63$, 0-4 bar, 1/4";
- 3/8" automatic air-vent valve. Nominal pressure: 12 bar;
- Safety valve 3 bar 200 kW. Inlet 1", outlet 1"1/4.

EPP insulation box (Dimensions: 230x175x104 mm).

Max Temperature 120°C.

Size: 1"1/4 Female swiveling nut.

Code: **SG200**



Adapter connection set for DN25 pump units

The set consists of a connection 1"1/4 F x 1"1/2 swivel nut and 1"1/2 EPDM gasket. It allows the installation of DN25 pump units on the DN32 zone manifolds. Yellow brass finish.



Two sets are required for each pump unit to be installed.

Code: **104629F-05**

1/2" adapter with sensor holder pit

For more informations see the pages dedicated to DN25 zone manifolds.

Code: **POZ-COL-6SET**



Wall fixing set for HW 80 hydraulic separator

Pair of brackets to fix to the wall the hydraulic separator with the insulation box 152x152 mm. Distance between the wall and the centre of the hydraulic separator: 160 mm.



Code: **DA0A-HW160**

Connection set 2" between hydraulic separator and zone manifold

The set allows to connect the hydraulic separator (at the side) to the zone manifold in a vertical position. It consists of:

- N° 3 connection sets 2" Fx2" F made of galvanized cast iron (pipe union, nut and connector);
- Galvanized angular pipe 2" male;

EPS insulation box

(Dimensions: 110x110x440 mm).

Code 2": **07629SETHW80**



Basic series

Art. 726

ANTI-SCALD THERMOSTATIC MIXING VALVE

Thermostatic mixing valve for small and medium applications for use in underfloor and radiator heating systems, domestic hot water.

The asymmetrical design of the body of the valve, where the mixed outlet is in line with the hot water connection, usually allows an easier installation. Hot forged brass body. Yellow brass finish. Control of the temperature supplied to the user, adjustable and available in three setting ranges.

- Maximum static pressure 10 bar (PN 10); dynamic pressure 5 bar;
- Maximum ratio between pressures 2:1;
- Maximum inlet temperature: 95°C;
- Calibration temperature range: 20÷45°C; 45÷70°C and 35÷60°C;
- Accuracy ±2°C within maximum performances;
- It can be used with anti freeze fluids (glycol ≤ 50%).

Available external connections:

3/4" (Kvs 1.5) and 1" (Kvs 1.8 and 3.4) Male flat seal.

The safety anti-scald function automatically stops the hot water flow in case of failure of the cold water line.

PED 2014/68/EU 4.3

Art. 720

Anti-scald thermostatic mixing valve for small and medium applications.

Asymmetric layout. Hot forged brass body. Yellow brass finish.

Available external connections:

1/2" (Kvs 1.5) and 3/4" (Kvs 1.8) Female.

Available technical features and adjustment temperatures are the same as Art. 726.

PED 2014/68/EU 4.3



Code 3/4" Kvs 1,5: **03726-F(3/4/5)-1.5**

Code 1" Kvs 1,8: **04726-F(3/4/5)-1.8**

Code 1" Kvs 3,4: **04726-F(3/4/5)-3.4**

F3	20÷45°C
F4	45÷70°C
F5	35÷60°C

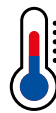

Available temperatures:

From **20°C** up to **45°C** (code F3)

From **45°C** up to **70°C** (code F4)

From **35°C** up to **60°C** (code F5)



Available Kvs:

1.5 = Maximum Kvs 1.55; up to 32 L/min (1.5 bar). Nominal Kv 1.52 (*)

1.8 = Maximum Kvs 1.8; up to 37 L/min (1.5 bar). Nominal Kv 1.77 (*)

3.4 = Maximum Kvs 3.4; up to 70 L/min (1.5 bar). Nominal Kv 3.3 (*)

(*) Tests carried out in our lab, under the test conditions listed below, with a differential pressure of 1 bar (without connection devices):

F3: Th:55°C, Tc:24°C, Tmix:32°C

F4: Th:75°C, Tc:40°C, Tmix:55°C

F5: Th:65°C, Tc:10°C, Tmix:51°C

Kvs 1.52 → 25.3 L/min

Kvs 1.77 → 29.5 L/min

Kvs 3.3 → 56 L/min



Renewed range,
new temperatures
20÷45°C and 45÷70°C



Code 1/2" Kvs 1,5: **02720-F(3/4/5)-1.5**

Code 3/4" Kvs 1,8: **03720-F(3/4/5)-1.8**



In compliance to the Italian Ministerial Decree N°174/2004.

Following specific laboratory tests, the mixing valve, art 726, has been verified to comply with D.M. 174/2004. The other articles of the same family of thermostatic mixing valves are similar to the verified model, having the same components and equal contact surface.

Art. 729

Anti-scald thermostatic mixing valve for small and medium applications.
Asymmetric layout. Hot forged brass body with pipe union connections.
Yellow brass finish. Check valves built into fittings at the inlets of hot and cold water.

Available external connections:

3/4" (Kvs 1.8 and 3.4) Male with pipe union.

Available technical features and adjustment temperatures are the same as Art. 726.



Code 3/4" Kvs 1,8: **03729-F(3/4/5)-1.8**

Code 3/4" Kvs 3,4: **03729-F(3/4/5)-3.4**

PED 2014/68/EU 4.3

Set union connections - Basic series

Set union connections for thermostatic mixing valve, consisting of: 1" coupling nuts, flat gaskets, and 3/4" male union tail pieces. Two tail pieces, specific for the mixer inlets, are equipped with check valve.

Maximum inlet temperature: 95°C.

Connection: 3/4" M x 1" Swivel nut.

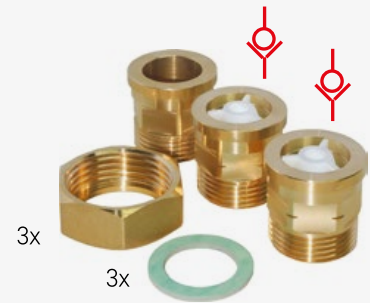

Code: **03729SET**

Multimix Series

Art. 736



ANTI-SCALD THERMOSTATIC MIXING VALVE

Applications

High performance thermostatic mixing valve for applications in underfloor and radiator heating systems, domestic hot water and solar thermal.

The asymmetrical design of the body of the valve, where the mixed outlet is in line with the hot water connection, usually allows an easier installation. The exceptionally high flowrate of the model with 4.0 Kvs is guaranteed by the generously sized shutter: a design choice that allows to work with a very short stroke with a great benefit to the adjustment accuracy when pressure and supply temperature change. In particular the model with 2.5 Kvs is mainly indicated in applications for drinking water at the point of use, as it can ensure a constant adjustment within $\pm 1^\circ\text{C}$. The 2.5 Kvs model is also characterized by particularly small dimensions.

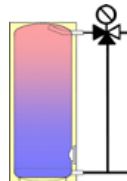
The table below enables to determine the most suitable model for the different installations allowed by MultiMix thermostatic mixing valves:

Underfloor or radiator heating	Domestic Hot Water: supply	Domestic Hot Water: user point	Solar Thermal
			
Kvs 4.0; F3/F4	Kvs 4.0; F4/F5	-	Kvs 4.0; F4
Kvs 2.5; F3/F4	-	Kvs 2.5; F4/F5	Kvs 2.5; F4

Technical features

Anti-scald thermostatic mixing valve with high performances.

Hot forged brass body. Yellow brass finish. Control of the temperature supplied to the user, adjustable and available in three setting ranges.

- Maximum static pressure 10 bar (PN 10); dynamic 5 bar.
- Max ratio between pressures: 2:1;
- Maximum inlet temperature: for F3 and F4 models continuous 100°C , (short time: 120°C for 20 s); for F5 model: 95°C ;
- Calibration temperature range: $20\div 45^\circ\text{C}$; $45\div 70^\circ\text{C}$ and $35\div 60^\circ\text{C}$;
- Accuracy: $\pm 2^\circ\text{C}$ (Kvs 4.0) and $\pm 1^\circ\text{C}$ (Kvs 2.5) within maximum performances;
- It can be used with anti freeze fluids (glycol $\leq 50\%$).

Available external connections: 1" Male flat seal.



Code 1" Kvs 2,5: **04736-F(3/4/5)-2.5**
Code 1" Kvs 4,0: **04736-F(3/4/5)-4.0**

F3	$20\div 45^\circ\text{C}$
F4	$45\div 70^\circ\text{C}$
F5	$35\div 60^\circ\text{C}$

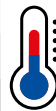

Available temperatures:

From 20°C up to 45°C (code F3)
From 45°C up to 70°C (code F4)
From 35°C up to 60°C (code F5)



Available Kvs:

- 4.0** = Maximum Kvs 4.0; up to 82 L/min (1.5 bar). Nominal Kv 3.6 (*)
- 2.5** = Maximum Kvs 2.5; up to 51 L/min (1.5 bar). Nominal Kv 2.4 (*)

(*) Tests carried out in our lab, under the test conditions listed below, with a differential pressure of 1 bar (without connection devices):

F3: Th: 55°C , Tc: 24°C , Tmix: 32°C
F4: Th: 75°C , Tc: 40°C , Tmix: 55°C
F5: Th: 65°C , Tc: 10°C , Tmix: 51°C
Kvs 2.4 \rightarrow 40.6 L/min
Kvs 3.9 \rightarrow 59.3 L/min



PED 2014/68/EU 4.3

Renewed range, new temperature $35\div 60^\circ\text{C}$



The safety anti-scald function automatically stops the hot water flow in case of failure of the cold water line.



In compliance to the Italian Ministerial Decree N°174/2004.

Following specific laboratory tests, the mixing valve, art 726, has been verified to comply with D.M. 174/2004. The other articles of the same family of thermostatic mixing valves are similar to the verified model, having the same components and equal contact surface.

Art. 730

Anti-scald thermostatic mixing valve with high performances.
Asymmetric layout. Hot forged brass body. Yellow brass finish.

Available external connections:
3/4" Female.

Available technical features and adjustment temperatures are the same as Art. 736.



Code 3/4" Kvs 2,5: **03730-F(3/4/5)-2.5**
Code 3/4" Kvs 4,0: **03730-F(3/4/5)-4.0**

PED 2014/68/EU 4.3

Art. 731C

Anti-scald thermostatic mixing valve with high performances.
Asymmetric layout. Hot forged brass body. Yellow brass finish. Mixed outlet fitted with 1" or 1 1/2 swivel nut (see picture at side) to be connected directly to the circulating pump.

Available external connections:
1" Swivel nut x 1" Male and 1 1/2 Swivel nut x 1" Male.

Available technical features and adjustment temperatures are the same as Art. 736.



Code 1" C x 1" M, Kvs 2,5: **04731C-04-F(3/4/5)-2.5**
Code 1" C x 1" M, Kvs 4,0: **04731C-04-F(3/4/5)-4.0**
Code 1 1/2 C x 1" M, Kvs 2,5: **04731C-06-F(3/4/5)-2.5**
Code 1 1/2 C x 1" M, Kvs 4,0: **04731C-06-F(3/4/5)-4.0**

PED 2014/68/EU 4.3

Art. 739

Anti-scald thermostatic mixing valve with high performances.
Asymmetric layout. Hot forged brass body with pipe union connections. Yellow brass finish. Check valves suitable for high temperature and filters built into fittings of hot and cold water, at both inlets.

Available external connections:
3/4" Male with pipe union.

Available technical features and adjustment temperatures are the same as Art. 736.



Code 3/4" Kvs 2,5: **03739-F(3/4/5)-2.5**
Code 3/4" Kvs 4,0: **03739-F(3/4/5)-4.0**

PED 2014/68/EU 4.3

Set union connections Multimix Series

Set union connections for thermostatic mixing valve, for thermal solar applications. It consists of: 1" coupling nuts, flat gaskets and 3/4" male union tail pieces. Two tail pieces, specific for the mixer inlets, are equipped with check valve and filters.

Maximum inlet temperature: 120°C.
Connection: 3/4" M x 1" Swivel nut.

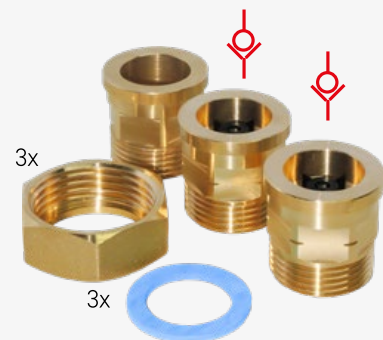

Code: **03739SET**

Art 796

ANTI-SCALD THERMOSTATIC MIXING VALVE

Anti-scald thermostatic mixing valve suitable for small and medium applications. DZR brass body for 3/4" and 1" sizes. Chrome plated. Adjustable user temperature from 30°C up to 65°C by means of a knob.

- Max static pressure 10 bar (PN 10); dynamic 5 bar;
- Max ratio between pressures 2:1;
- Max inlet temperature: 90°C;
- Setting range: 30÷65°C. Accuracy ± 2°C.

External connections: 3/4", 1", 1"1/4 and 1"1/2 Male flat seal.



Available Kvs:

- 1.5 (3/4" code 03796)** = Domestic use installations; up to 31 L/min (1.5 bar)
- 2.4 (1" code 04796)** = Small water consumption; up to 49 L/min (1.5 bar)
- 4.5 (1"1/4 code 05796)** = Middle water consumption; up to 92 L/min (1.5 bar)
- 5.0 (1"1/2 code 06796)** = Middle water consumption; up to 102 L/min (1.5 bar)



Available temperatures:

Adjustable temperature from **30°C to 65°C**



Layout: symmetric



- Code 3/4": **03796**
- Code 1": **04796**
- Code 1"1/4: **05796**
- Code 1"1/2: **06796**

PED 2014/68/EU 4.3

Art 799

ANTI-SCALD THERMOSTATIC MIXING VALVE

Anti-scald thermostatic mixing valve for small and medium applications with Male union connections. High temperature check valves and filters, built into fittings, at both inlets of hot and cold water. DZR brass body for 1/2" and 3/4" sizes. Chrome plated.

Same features as art. 796.

External connections: 1/2", 3/4", 1" and 1"1/4 Male union.



Available Kvs:

- 1.5 (1/2" code 02799)** = Domestic use installations; up to 31 L/min (1.5 bar)
- 2.4 (3/4" code 03799)** = Small water consumption; up to 49 L/min (1.5 bar)
- 4.5 (1" code 04799)** = Middle water consumption; up to 92 L/min (1.5 bar)
- 5.0 (1"1/4 code 05799)** = Middle water consumption; up to 102 L/min (1.5 bar)



Available temperatures:

Adjustable temperature from **30°C to 65°C**



Layout: symmetric



- Code 1/2": **02799**
- Code 3/4": **03799**
- Code 1": **04799**
- Code 1"1/4: **05799**

PED 2014/68/EU 4.3

The safety anti-scald function automatically stops the hot water flow in case of failure of the cold water line.

Thermostatic mixing valves with anti-scald protection

The thermostatic mixing valve is used in domestic hot water systems and it controls temperature to preset value. It allows to keep constant mixed water temperature for the end user, regardless of inlet conditions both of hot and cold water.

Knob: reference temperatures

Kvs	MIN	1	2	3	4	5	MAX
1,5 and 2,4	~27°C	30°C	41°C	48°C	56°C	65°C	~70°C
4,5 and 5,0	~29°C	31°C	46°C	53°C	60°C	65°C	~68°C

T_H = 65 °C T_c = 15 °C P = 3 bar

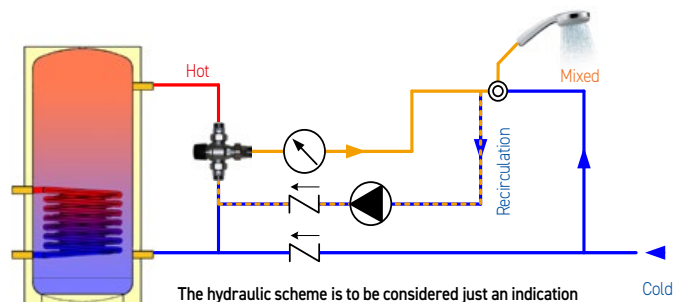

In compliance to the Italian Ministerial Decree N°174/2004.

Following specific laboratory tests, the mixing valve, art 726, has been verified to comply with D.M. 174/2004. The other articles of the same family of thermostatic mixing valves are similar to the verified model, having the same components and equal contact surface.

Max recommended flow rate for a constant flow within ±2°C.

Kvs	Max l/min	Kvs	Max l/min
1,5	31	4,5	92
2,4	49	5,0	102

THERMOSTATIC DIVERTING VALVES

DIVERTING VALVE 38÷54°C

Art. 789R

HIGH PERFORMANCE ADJUSTABLE THERMOSTATIC DIVERTING VALVE

Thermostatic diverting valve with adjustable diverting temperature from 38°C up to 54°C by means of a graduated knob. Possibility of anti-rotation locking of the knob. High temperature check valve and filter built into the inlet connection. Hot forged brass body. Yellow brass finish.

In accordance with the inlet temperature, the valve diverts the water between the outlets 1 and 2 in a proportional and automatic way: at values lower than the setting temperature towards the port 1, at values higher than the setting temperature towards the port 2.

- Maximum static pressure 10 bar (PN 10); dynamic pressure 5 bar;
- Maximum inlet temperature: continuous 100°C (short time: 120°C for 20 s);
- Calibration temperature range: 38°C÷54°C.
- Commutation field 4K (between 42 and 52°C);
- It can be used with anti freeze fluids (glycol ≤ 50%).

Available external connections: 3/4" Male pipe unions.



Kvs values:

- 2,5 Towards the port 1
- 3,5 Towards the port 2

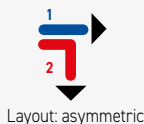

Diverting temperature:

Adjustable temperature from 38°C up to 54°C

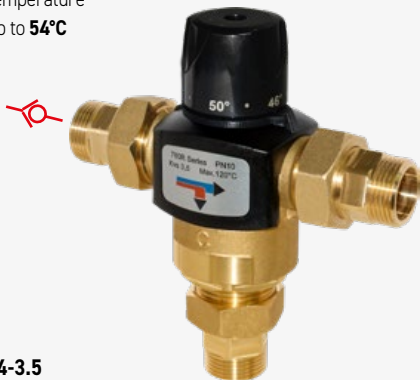

Code 3/4": **03789R-3854-3.5**

PED 2014/68/EU 4.3



In compliance to the Italian Ministerial Decree N°174/2004.

Following specific laboratory tests, the mixing valve, art 726, has been verified to comply with D.M. 174/2004. The other articles of the same family of thermostatic mixing valves are similar to the verified model, having the same components and equal contact surface.

Art. 786R

Thermostatic diverting valve with adjustable diverting temperature from 38°C up to 54°C by means of a graduated knob. Possibility of anti-rotation locking of the knob. Hot forged brass body. Yellow brass finish.

Available external connections: 1" male flat seal.

Technical features and available setting temperatures are the same as the ones of art. 789R.



Code 1": **04786R-3854-3.5**

PED 2014/68/EU 4.3

Set union connections

Set union connections for thermostatic diverting valve

It consists of: 1" coupling nuts, flat gaskets and 3/4" male union tail pieces. One tail piece, specific for the mixer inlet, is equipped with check valve and filter.

Maximum inlet temperature: 120°C.

Connection: 3/4" M x 1" Swivel nut.

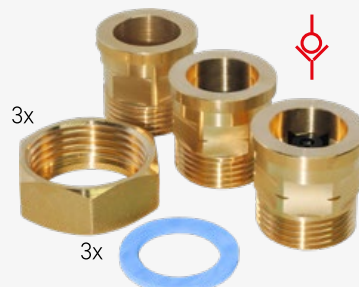

Code: **03789RSET**

Art. 1610
MOTORIZED ZONE VALVE

F/F full bore 2-way zone ball valve made of forged brass.

- Yellow brass finish.
- Threaded connections ISO 228 (DIN 259 BSP 2779).
- Bidirectional actuator with quick "clip" connection to the valve.
- Power supply 230 V AC.

PN 32. Working pressure: 16 bar.
Max differential pressure: 10 bar.
Fluid temperature: -20÷120°C

Codes: **see table**

PED 2014/68/EU 4.3



With bidirectional actuator



		DN15 ; 1/2" Kvs 23 Code: 021610	DN20 ; 3/4" Kvs 38,5 Code: 031610	DN25 ; 1" Kvs 76 Code: 041610	DN32 ; 1 1/4" Kvs 103 Code: 051610
	M11 2P, 5 Nm, 20" Code: M11	021610-M11	031610-M11	-	-

		DN15 ; 1/2" Kvs 23 Code: 021610	DN20 ; 3/4" Kvs 38,5 Code: 031610	DN25 ; 1" Kvs 76 Code: 041610	DN32 ; 1 1/4" Kvs 103 Code: 051610
	M15 2P, 15 Nm, 48" Code: M15	-	-	041610-M15	051610-M15

ROTARY MIXING VALVES

3-WAY

Art. 1055 / 1056

3-WAY ROTARY MIXING VALVE

Rotary mixing valve made of forged brass suitable for heating and cooling applications. Yellow finish. The valve is suitable for motor drive coupling by an actuator of the ModvlvS range or by others available on the market. The special proportional shape of the adjustment vane makes linear the working of the valve and allows always symmetrical installations. An easy numbering on the upper part of the valve helps to understand correctly the connection schemes indicated in the instruction sheet, without any possibility of mistake. As concerns the manual working an additional stained indicator fixes the working field and the working direction in an univocal way.

- PN 10. Maximum temperature 110°C (short time: 160°C for 20 s.)
- Maximum leakrate in % of flow rate: 0.05
- Working torque: < 3 Nm
- It works as a mixing or a diverting valve
- Codes: see the chart here below

Available external connections: Male threads flat seal and Female.



The kit of rotary mixing valve and 3-point actuator is available

Bidirectional, reversible, operating range of 90°, 140 s. Torque 5 Nm. 230V, IP40.
Please add the suffix **-NR** to the code of the valve.



Codes: see the chart here below



Available Kvs:
from 2.5 up to 25

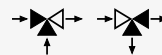

Working:
mixing, diverting

PED 2014/68/EU 4.3

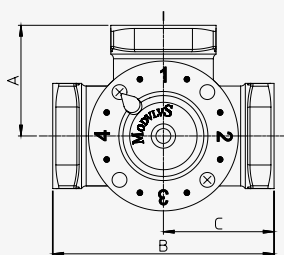

Art. 1055 - Female thread

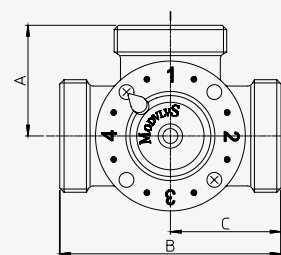

Art. 1056 - Male thread

Code	Model	DN	Kvs	Conn.	A	B	C
021055-2.5(-NR)	1055	15	2,5	G 1/2"	36	72	36
021055-4.0(-NR)	1055	15	4,0	G 1/2"	36	72	36
031055-4.0(-NR)	1055	20	4,0	G 3/4"	36	72	36
031055-6.3(-NR)	1055	20	6,3	G 3/4"	36	72	36
031055-10(-NR)	1055	20	10,0	G 3/4"	36	72	36
041055-10(-NR)	1055	25	10,0	G 1"	41	82	41
041055-16(-NR)	1055	25	16,0	G 1"	41	82	41
051055-16(-NR)	1055	32	16,0	G 1 1/4"	47	94	47
061055-25(-NR)	1055	40	25,0	G 1 1/2"	53	106	53

Code	Model	DN	Kvs	Conn.	A	B	C
031056-2.5(-NR)	1056	15	2,5	G 3/4"	36	72	36
031056-4.0(-NR)	1056	15	4,0	G 3/4"	36	72	36
041056-4.0(-NR)	1056	20	4,0	G 1"	36	72	36
041056-6.3(-NR)	1056	20	6,3	G 1"	36	72	36
041056-10(-NR)	1056	20	10,0	G 1"	36	72	36
051056-10(-NR)	1056	25	10,0	G 1 1/4"	41	82	41
051056-16(-NR)	1056	25	16,0	G 1 1/4"	41	82	41
061056-16(-NR)	1056	32	16,0	G 1 1/2"	47	94	47
071056-25(-NR)	1056	40	25,0	G 2"	53	106	53

Art. 1065 / 1066

4-WAY ROTARY MIXING VALVE

Rotary mixing valve made of forged brass suitable for heating and cooling applications. Yellow finish. The valve is suitable for motor drive coupling by an actuator of the ModvlvS range or by others available on the market. An easy numbering on the upper part of the valve helps to understand correctly the connection schemes indicated in the instruction sheet, without any possibility of mistake. As concerns the manual working an additional stained indicator fixes the working field and the working direction in an univocal way.

- PN 10. Maximum temperature 110°C (short time: 160°C for 20 s.)
- Maximum leakrate in % of flow rate: 0.05
- Working torque: < 3 Nm
- Suitable for heating, cooling and solar thermal systems
- Suitable to be used with antifreeze fluids (glycol < 50%)

Available external connections: Male threads flat seal and Female.



The kit of rotary mixing valve and 3-point actuator is available

Bidirectional, reversible, operating range of 90°, 140 s. Torque 5 Nm. 230V, IP40.
Please add the suffix **-NR** to the code of the valve.



Codes: [see the chart here below](#)



Available Kvs:
from 2.5 up to 25

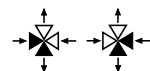

Working:
mixing

PED 2014/68/EU 4.3

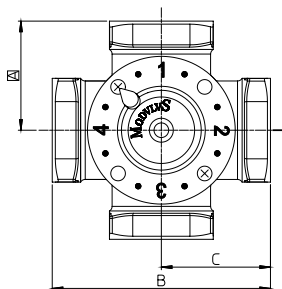

Art. 1065 - Female thread

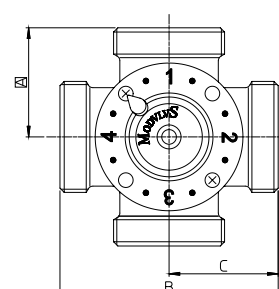

Art. 1066 - Male thread

Code	Model	DN	Kvs	Conn.	A	B	C
021065-2.5(-NR)	1065	15	2,5	G 1/2"	36	72	36
021065-4.0(-NR)	1065	15	4,0	G 1/2"	36	72	36
031065-4.0(-NR)	1065	20	4,0	G 3/4"	36	72	36
031065-6.3(-NR)	1065	20	6,3	G 3/4"	36	72	36
041065-10(-NR)	1065	25	10,0	G 1"	41	82	41
041065-14(-NR)	1065	25	14,0	G 1"	41	82	41
051065-16(-NR)	1065	32	16,0	G 1 1/4"	47	94	47
061065-25(-NR)	1065	40	25,0	G 1 1/2"	53	106	53

Code	Model	DN	Kvs	Conn.	A	B	C
031066-2.5(-NR)	1066	15	2,5	G 3/4"	36	72	36
031066-4.0(-NR)	1066	15	4,0	G 3/4"	36	72	36
041066-4.0(-NR)	1066	20	4,0	G 1"	36	72	36
041066-6.3(-NR)	1066	20	6,3	G 1"	36	72	36
051066-10(-NR)	1066	25	10,0	G 1 1/4"	41	82	41
051066-14(-NR)	1066	25	14,0	G 1 1/4"	41	82	41
061066-16(-NR)	1066	32	16,0	G 1 1/2"	47	94	47
071066-25(-NR)	1066	40	25,0	G 2"	53	106	53

ROTARY MIXING VALVES FOR DISTRIBUTION BOXES



Code 1" Swivel nut: **041031C-04**

PED 2014/68/EU 4.3



Layout: asymmetric



FIELD OF USE

For power up to 40 kW, with Δt 20 K, or up to 16 kW with Δt 8 K.
Maximum flow rate 1700 l/h. Kvs value: 6.8
Approximate data with a 6 m head circulating pump.

Test made at our laboratory, with a head loss of 0,5 mH₂O:
Th:55°C Tc:24°C Tmix:32°C → 18,6 l/min (Kv 5)

Art. 1031C

3-WAY ROTARY MIXING VALVE FOR DISTRIBUTION BOXES

Applications

Compact 3-way rotary mixing valve, specifically designed for heating interface units or distribution boxes for underfloor systems.

It is suitable for actuator drive coupling by a standard 3 point, a proportional, a fixed temperature actuator or by an integrated climatic controller. The special mixing chamber allows very high hydraulic performances with very low head losses. The external dimensions and the connections make the valve interchangeable with the thermostatic mixing valve Art. 731C DN25.

Technical features

3-way rotary mixing valve for medium and large surfaces.
Body made of hot pressed brass. Yellow brass finish.

- PN10. Maximum temperature 110°C;
- Kvs value: 6.8: Maximum leak rate in % of flow rate: 0.05;
- It can be motorized by ModvlvS range of actuators or by others on sale;
- Working torque: less than 3 Nm;
- Interchangeable with the thermostatic mixing valve Art. 731C DN25.

Available external connections: 1" Male x 1" Swivel Nut (mixed outlet).

Example of use for underfloor manifold

In this case the mixing valve has been motorized and it is a part of the kit **ModvlvS Art.687 MIX** equipped with Wilo circulation pump and Differential by-pass valve.

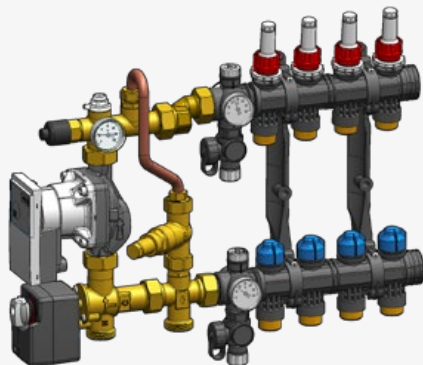

Art. 1031C

Motorized with
ModvlvS TRM20 actuator.



Art. 1036

Compact 3-way rotary mixing valve, specifically designed for heating interface units or distribution boxes for underfloor systems.

It is suitable for actuator drive coupling by a standard 3 point, a proportional, a fixed temperature actuator or by an integrated climatic controller. The external dimensions and the connections make the valve interchangeable with the thermostatic mixing valve Art. 736 DN25.

Available external connections: 1" Male flat gasket seal.

The technical features are the same indicated for the Art. 1031C.

Code 1": **041036**

PED 2014/68/EU 4.3





686L FIX
FIXED TEMPERATURE KIT BASIC SERIES

The control kit Art. 686L FIX, thanks to very small dimensions, can be set up straight into the distribution box of radiant heating systems. Its design allows the mounting on the right side or on the left side of the manifold.

The unit for 1/2" circulating pumps (130 mm) consists of:

- 3-way thermostatic mixing valve with piston shutter (Kvs 3.4) and adjustable temperature 20÷45°C (F3) or 35÷60°C (F5);
- Pre-wired high efficiency synchronous circulating pump (for the models that include it);
- Thermometer 0÷60°C;
- Air-vent valve;
- Direct connection to the manifold or by means of an eccentric piece 15 or 30 mm (manifold misalignment between the supply and the return).

Centre distance 210 mm

PN 10, maximum temperature 110°C (unit without circulating pump).

Connection to the manifold: 1" Male swivel connection or 1" swivel nut;

Connection to the circuit: 1" Male with 76 mm centre distance.

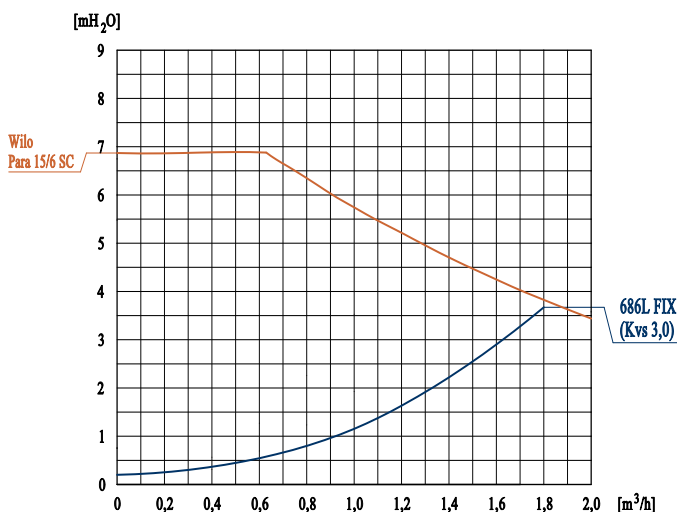

Codes: see table.

F3	20÷45°C
F5	35÷60°C



Available temperatures:

From 20°C to 45°C (code F3)

From 35°C to 60°C (code F5)

PED 2014/68/EU 4.3

FIELD OF USE

For power up to 8 kW (with Δt 8 K) and maximum flow rate 900 l/h. Kvs value: 3.0.

Approximate data calculated with a 6 m head circulating pump. For an accurate sizing or for higher flow rates, please refer to the curve.



Compact size,
easy installation



Approximate data for radiant heating systems: codes of the F3 version

Setting range	Δt	Approximate power and flow rate of the application	Circulating pump	Residual head	Approximate surface of the radiant system	Eccentric piece	1" swivel nut code	1" Male swivel connection code
20÷45°C	8 K	8 kW - 900 L/h	Wilo Para SC 15/6	5 mH ₂ O	Up to 90 m ²	-	104686LC-F3-P6	104686LG-F3-P6
						15 mm	104686LC-F3-15P6	104686LG-F3-15P6
						30 mm	104686LC-F3-30P6	104686LG-F3-30P6

Approximate data for radiant heating systems: codes of the F5 version

Setting range	Δt	Approximate power and flow rate of the application	Circulating pump	Residual head	Approximate surface of the radiant system	Eccentric piece	1" swivel nut code	1" Male swivel connection code
35÷60°C	8 K	8 kW - 900 L/h	Wilo Para SC 15/6	5 mH ₂ O	Up to 90 m ²	-	104686LC-F5-P6	104686LG-F5-P6
						15 mm	104686LC-F5-15P6	104686LG-F5-15P6
						30 mm	104686LC-F5-30P6	104686LG-F5-30P6

Codes variance: For the versions without the circulating pump, please skip the identification code of the pump P6

UNDERFLOOR HEATING CONTROL KIT KIT FOR DISTRIBUTION BOXES



HEATING AND COOLING

687 FIX FIXED TEMPERATURE KIT

The control kit Art. 687 FIX, thanks to very small dimensions, can be set up straight into the distribution box of radiant heating systems. Its design allows the mounting on the right side or on the left side of the manifold.

The unit for 1/2" (130 mm) circulating pumps consists of:

- 3-way thermostatic mixing valve with high hydraulic performances (Kvs 4.0) and adjustable temperature 20÷45°C (F3) or 35÷60°C (F5);
- Pre-wired high efficiency synchronous circulating pump (for the models that include it);
- Thermometer 0÷60°C;
- Air-vent valve;
- Safety thermometer pit with fixed setting temperature 55°C (it can be ordered separately);
- Ready for the addition of differential by-pass valve (it can be ordered separately);
- Direct connection to the manifold or by means of an eccentric piece 15 or 30 mm (manifold misalignment between the supply and the return).

Centre distance 210 mm

PN 10, maximum temperature 110°C (unit without circulating pump).

Connection to the manifold: 1" Male swivel connection or 1" swivel nut;

Connection to the circuit: 1" Male with 96 mm centre distance.

FIELD OF USE

For power up to 9 kW (with Δt 8 K) and maximum flow rate 1000 l/h. Kvs value: 3.4

Approximate data calculated with a 6 m head circulating pump. For an accurate sizing or for higher flow rates, please refer to the curve.

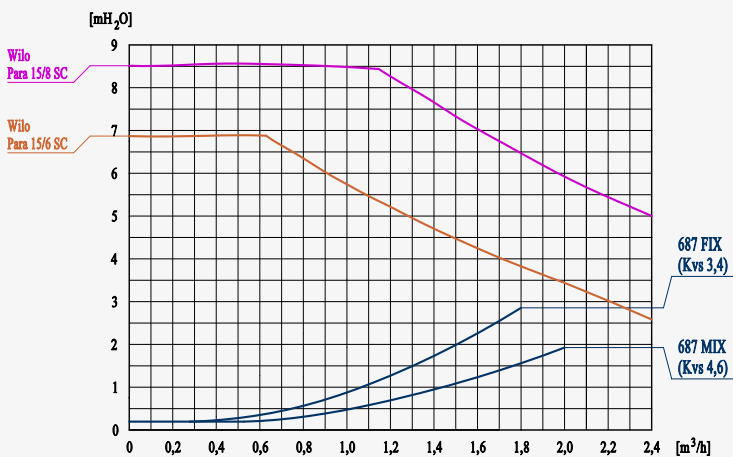

Approximate data for radiant heating systems: codes of the F3 version

Setting range	Δt	Approximate power and flow rate of the application	Circulating pump	Residual head	Approximate surface of the radiant system	Eccentric piece	1" swivel nut code	1" Male swivel connection code
20÷45°C	8 K	9 kW - 1000 L/h	Wilo Para 15/6 SC	5 mH_2O	Up to 100 m^2	-	104687C-F3-P6	104687G-F3-P6
						15 mm	104687C-F3-15-P6	104687G-F3-15-P6
						30 mm	104687C-F3-30-P6	104687G-F3-30-P6
		15 kW - 1600 L/h	Wilo Para 15/8 SC	5 mH_2O	Up to 150 m^2	-	104687C-F3-P8	104687G-F3-P8
						15 mm	104687C-F3-15-P8	104687G-F3-15-P8
						30 mm	104687C-F3-30-P8	104687G-F3-30-P8

Codici: see table below.



Available thermostatic mixing valves:

Temperature range 20-45°C (F3)

Temperature range 35-60°C (F5)



Available circulating pumps:

Wilo Para 15/6 SC (P6)

Wilo Para 15/8 SC (P8)

PED 2014/68/EU 4.3



Safety thermostat

Safety thermostat with fixed setting temperature 55°C. Connection 1/2" Male. NC. 10(1)A/250 VAC. Maximum temperature: 120°C, Maximum pressure 80 bar.



Code: BRC-55



Approximate data for radiant heating systems: codes of the F5 version

Setting range	Δt	Approximate power and flow rate of the application	Circulating pump	Residual head	Approximate surface of the radiant system	Eccentric piece	1" swivel nut code	1" Male swivel connection code
35+60°C	8 K	9 kW - 1000 L/h	Wilo Para 15/6 SC	5 mH ₂ O	Up to 100 m ²	-	104687C-F5-P6	104687G-F5-P6
						15 mm	104687C-F5-15-P6	104687G-F5-15-P6
						30 mm	104687C-F5-30-P6	104687G-F5-30-P6
		15 kW - 1600 L/h	Wilo Para 15/8 SC	5 mH ₂ O	Up to 150 m ²	-	104687C-F5-P8	104687G-F5-P8
						15 mm	104687C-F5-15-P8	104687G-F5-15-P8
						30 mm	104687C-F5-30-P8	104687G-F5-30-P8

Note. Code variance. For the versions without the circulating pump please skip the identification code of the pump "-P6" / "-P8".
For example: 1" swivel male connection, 20÷45°C without circulating pump with eccentric piece 15 mm: **code 104687G-F3-15**

687 MIX
3-WAY ROTARY MIXING VALVE KIT

The control kit Art. 687 MIX, thanks to very small dimensions, can be set up straight into the distribution box of radiant heating systems. Its design allows the mounting on the right side or on the left side of the manifold.

The unit for 1/2" (130 mm) circulating pumps consists of:

- Compact 3-way rotary mixing valve with very high hydraulic performances (Kvs 6.8).
- It can be motorized by the ModvlvS range of actuators or by others on sale;
- Pre-wired high efficiency synchronous circulating pump (for the models that include it);
- Thermometer 0÷60°C;
- Air-vent valve;
- Safety thermometer pit with fixed setting temperature 55°C (it can be ordered separately);
- Ready for the addition of differential by-pass valve (it can be ordered separately);
- Direct connection to the manifold or by means of an eccentric piece 15 or 30 mm (manifold misalignment between the supply and the return).

Centre distance 210 mm

PN 10, maximum temperature 110°C (unit without circulating pump).

Connection to the manifold: 1" Male swivel connection or 1" swivel nut;

Connection to the circuit: 1" Male with 96 mm centre distance.

FIELD OF USE

For power up to 11 kW (with Δt 8 K) and maximum flow rate 1200 l/h. Kvs value: 4.6

Approximate data calculated with a 6 m head circulating pump. For an accurate sizing or for higher flow rates, please refer to the curve.

Codici: **see table below.**



Available circulating pumps:

Wilo Para 15/6 SC (P6)

Wilo Para 15/8 SC (P8)

PED 2014/68/EU 4.3



687 MIX: approximate data for radiant heating systems

Δt	Approximate power and flow rate of the application	Circulating pump	Residual head	Approximate surface of the radiant system	Eccentric piece	1" swivel nut code	1" Male swivel connection code
8 K	11 kW - 1200 L/h	Wilo Para 15/6 SC	5 mH ₂ O	Up to 120 m ²	-	104687C-M3-P6	104687G-M3-P6
					15 mm	104687C-M3-15-P6	104687G-M3-15-P6
					30 mm	104687C-M3-30-P6	104687G-M3-30-P6
	17 kW - 1800 L/h	Wilo Para 15/8 SC	5 mH ₂ O	Up to 200 m ²	-	104687C-M3-P8	104687G-M3-P8
					15 mm	104687C-M3-15-P8	104687G-M3-15-P8
					30 mm	104687C-M3-30-P8	104687G-M3-30-P8

Note. Code variance. For the versions without the circulating pump please skip the identification code of the pump "-P6" / "-P8".
For example: 1" swivel male connection, without circulating pump with eccentric piece 15 mm: **code 104687G-M3-15**



Code: 103901-687

PED 2014/68/EU 4.3

Art. 901 Differential by-pass valve (Bypass)

Differential by-pass valve for the pressure balancing of the heating system, equipped with fittings for the direct mounting on the control unit of the radiant panels. Yellow brass finish.

Setting range: 0÷0.5 bar.
Centre distance 210 mm.
Kvs value: 5.0

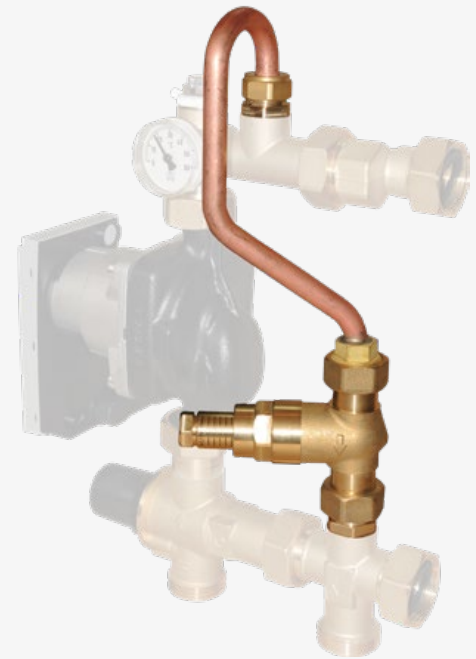

Example of use for underfloor manifold

in this case the mixing valve has been motorized and it is a part of the kit ModvlvS Art.687 MIX equipped with Wilo circulation pump and Differential by-pass valve.

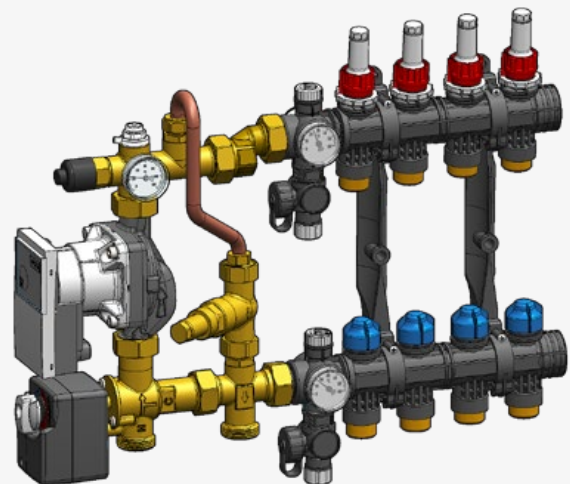

DomvS Clima

CONTROL UNIT FOR DISTRIBUTION MANIFOLDS
FOR APPLICATIONS WITH RADIANT HEATING
AND COOLING PANELS

Complete Kit:

- Room Controller
- Power Unit
- Circulating Pump
- Motorized or
Thermostatic mixing valve

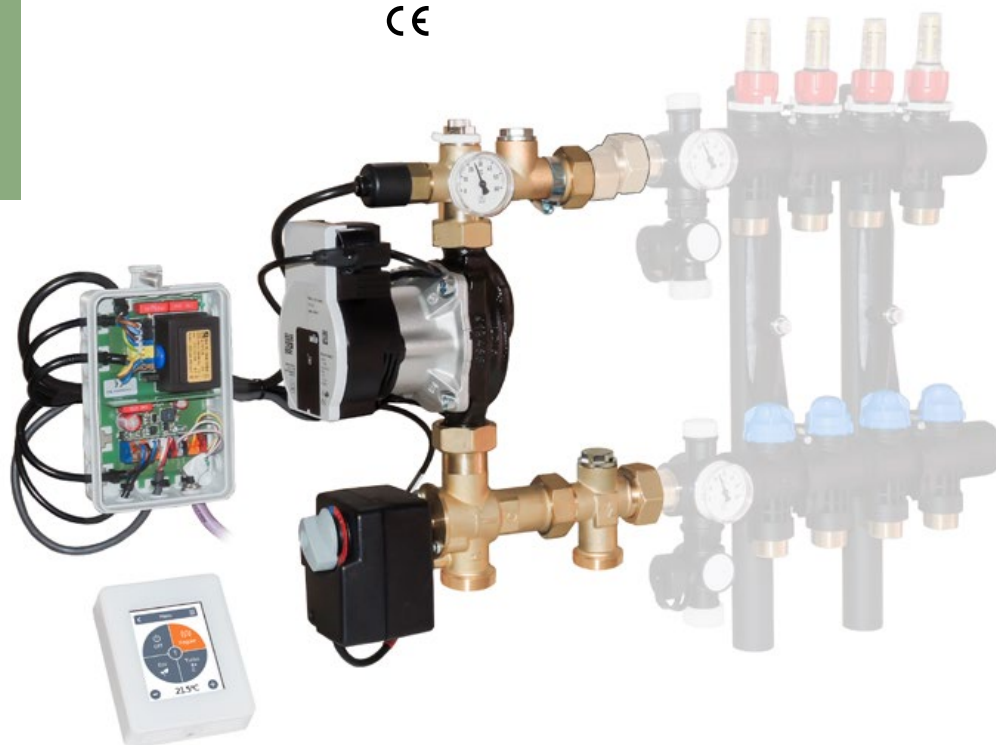

Codes: see table.

AVAILABLE UNTIL SELL-OUT

PED 2014/68/EU 4.3



Applications

Innovative control unit for distribution manifolds for applications with radiant systems.

It consists of:

- **Control unit, Art 687, with fixed point thermostatic mixing valve (heating) or motorized rotary mixing valve (heating and cooling);**
- **Power supply and control unit to be inserted into the distribution box; power cable, circulating pump, supply sensor, safety thermostat and possible actuator are already pre-wired;**
- **Elegant room control unit with TFT capacitive touch screen for remote control of the system.**

Reasons to choose DomvS Clima

- Extremely easy to install thanks to the factory pre-wired system. Only the room thermostat will be connected on site to the power unit with a multipolar cable;
- Guided start-up in the choice of the most suitable settings for the type of insulation (class) of the living unit;
- The intelligent logic intervenes adaptively to the tendential variation of the room temperature by acting on the speed of the circulating pump, in the thermostatic model, or on the flow temperature of the fluid in the version with motorized rotary mixing valve. In this way the system can manage different temperatures in the different set time bands - which is impossible with the normal on/off thermostatic systems.

Main features

Room controller

- Selectable insulation class of the housing unit for greater comfort and energy saving;
- Operating mode: Normal, Turbo, Eco and Off with specific setpoint temperature;
- Holiday program;
- Up to 8 selectable heating daily time bands.

Hydraulic module

- Fixed point thermostatic mixing valve or motorized rotary mixing valve;
- 8 meter head synchronous circulating pump for radiant surfaces up to 200 m²;
- Ready for the addition of differential by-pass valve;
- Direct connection to the manifold by means of an eccentric piece, 15 mm or 30 mm (manifold misalignment between supply and return).

Centre distance 210 mm

PN 10, maximum temperature 100°C.

Connection to the manifold: 1" Male swivel connection or 1" swivel nut

Connection to the circuit: 1" Male with 96 mm centre distance.

UNDERFLOOR HEATING CONTROL KIT KIT FOR DISTRIBUTION BOXES

Room controller with intelligent logic and adaptive action

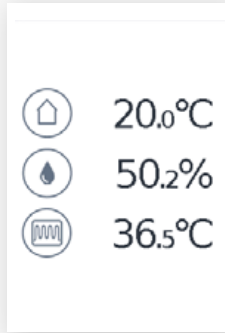

Info screen



Selection of the insulation class of the housing unit



Intuitive time switch for week program

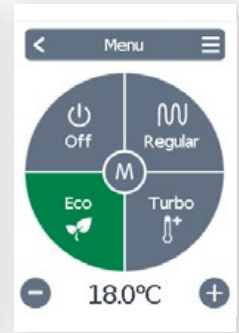

Saving-energy mode with reduced temperature

Field of use and codes for ordering

DomvS Clima provided with fixed point thermostatic mixing valve

Function	Setting range	Δt	Approximate power and flow rate of the application	Kvs	Residual lifting power head	Approximate surface of the radiant system	Connection end	Code
Heating	20-45°C	8 K	15 kW - 1600 L/h	3.4	5 mH ₂ O	Up to 150 m ²	1" M swivel conn.	104687G-RC-F3-P8
							1" F swivel nut	104687C-RC-F3-P8

AVAILABLE UNTIL SELL-OUT

DomvS Clima provided with rotary mixing valve with actuator

Function	Setting range	Δt	Approximate power and flow rate of the application	Kvs	Residual head	Approximate surface of the radiant installation	Connection end	Code
Heating	20-55°C (*)	8 K	17 kW - 1800 L/h	4.6	5 mH ₂ O	Up to 200 m ²	1" M swivel	104687G-RF-M3-P8
Cooling	(**)	3 K	6.5 kW - 1800 L/h				1" F swivel nut	104687C-RF-M3-P8

AVAILABLE UNTIL SELL-OUT

(*) Temperature limited by the safety thermostat

(**) Selectable temperature: fixed or calculated according to the condensation curve



Note: The manifold inlet connection, straight or eccentric, is not included. It must be ordered separately according to the manifold's connection type, male or female, and to the centre distance of the manifolds to be used.

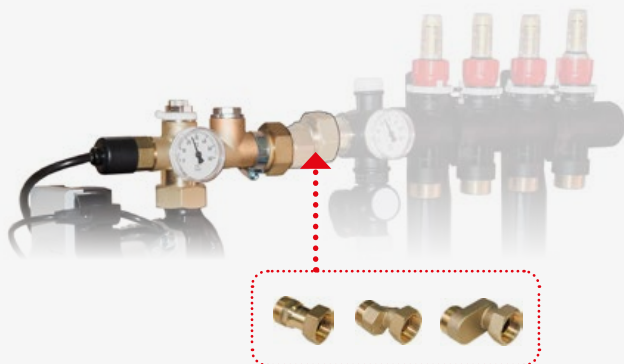

Connection to the manifold 1" swivel male



STRAIGHT
Code: **SET687G**

ECCENTRIC 15 mm
Code: **SET687G-15**

ECCENTRIC 30 mm
Code: **SET687G-30**

Connection to the manifold 1" swivel nut



STRAIGHT
Code: **SET687C**

ECCENTRIC 15 mm
Code: **SET687C-15**

ECCENTRIC 30 mm
Code: **SET687C-30**

Climatic controllers

Main features common to both models:

- Bright backlight high contrast display with full text notes and graphic mode;
- Pictograms showing the chosen hydraulic scheme highlighting the status of activity of the relays;
- Assistant to the start with step-by-step guided setups;
- Data storage with statistics and graphics diagrams for a long term monitoring of the outside and supply temperature, check function with error storage;
- CAN-BUS connection for connecting multiple hydraulic modules;
- Possibility of remote management and data storage with Connect system (the specific Datalogger is required, not included);
- Optional time bands, with performance curve corrector, for the working of the installation in day, night and comfort mode;
- Temperature limit, for day and night deactivation of the plant;
- Setting of performance curve, with linear or splitted slope;
- Antifreeze and daily or weekly anti-lock function;
- Setting of minimum and maximum supply temperature of the plant;
- Comfort function for quick heating;
- °Caleon room thermostat (non included);
- Menu lockout against undesired setting changes;
- 24 VDC outputs for external devices (e.g. °Caleon or actuators)
- Dimensions: 163 x 110 x 51 mm;
- IP 40 - protection class II.



MHCC - Climatic controller

Control of a mixed circuit with heat request

• 2 application schemes

- 3 inputs for PT1000 sensors;
- 1 input for remote control;
- 1 output for energy source management;
- 2 output relays 230V;
- 1 output 24 VDC, up to 2 W

It includes:

- 1 silicone temperature sensor TT/S4 PT1000;
- 1 outside temperature sensor TA/55 (PT1000);
- 1 contact sensor for supply pipe TR/S2 (PT1000).

Code: **MHCC-24**

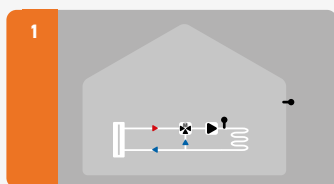

Mixed circuit

MHCC Hydraulic Variants



Mixed circuit + boiler (*)

(*) Boiler control is 0-10V or PWM. To change the signal into potential free please use the outside optional relay.

LHCC - Climatic controller

Control of various heating and cooling systems, DHW with anti-legionella function

• More than 22 application schemes, extensible with additional selectable functions

- 6 inputs for PT1000 sensors;
- 1 input for remote control;
- 2 inputs for flow direct sensors;
- 2 output 0-10 V / PWM;
- 3 output relays 230V
- 1 output with zero-potential contact;
- 1 output 24 DC, up to 6 W

It includes:

- 1 silicone temperature sensor TT/S4 PT1000;
- 1 outside temperature sensor TA/55 (PT1000);
- 1 contact sensor for supply pipe TR/S2 (PT1000).

Code: **LHCC-24**

LHCC Hydraulic variants

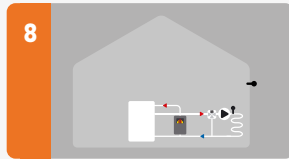
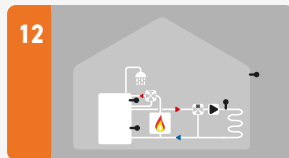
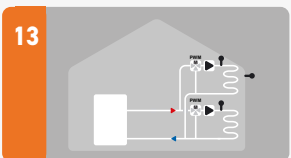
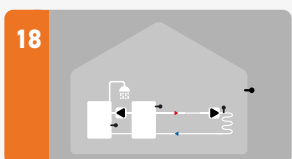
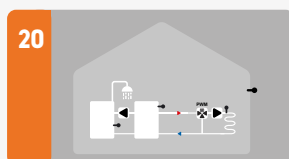
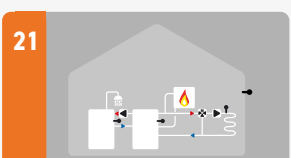
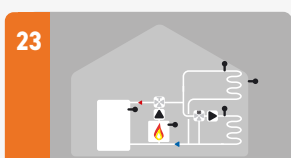
<p>1</p>  <p>Heating circuit and burner</p>	<p>2</p>  <p>Mixed heating circuit</p>	<p>3</p>  <p>Mixed PWM heating circuit</p>	<p>4</p>  <p>Mixed heating circuit and burner</p>																								
<p>5</p>  <p>Mixed heating circuit, burner and solar</p>	<p>6</p>  <p>Mixed heating circuit and heat pump</p>	<p>7</p>  <p>Mixed heating circuit, heat pump and solar</p>	<p>8</p>  <p>Mixed heating circuit and solid fuel boiler</p>																								
<p>9</p>  <p>Mixed heating circuit, heat pump and cooling function</p>	<p>10</p>  <p>2 heating circuits, combined water tank, DHW-valve and burner</p>	<p>11</p>  <p>Mixed heating circuit, unmixed heating circuit and burner</p>	<p>12</p>  <p>Mixed heating circuit, DHW-valve and burner.</p>																								
<p>13</p>  <p>2 mixed PWM heating circuit</p>	<p>14</p>  <p>Mixed PWM heating circuit, DHW, solar, burner and zone valve</p>	<p>15</p>  <p>Mixed heating circuit and solid fuel boiler</p>	<p>16</p>  <p>Mixed PWM heating circuit and solid fuel boiler</p>																								
<p>17</p>  <p>Mixed heating circuit, solid fuel boiler, and burner</p>	<p>18</p>  <p>Unmixed heating circuit, DHW, and heat transfer</p>	<p>19</p>  <p>Mixed heating circuit, DHW, and heat transfer</p>	<p>20</p>  <p>Mixed PWM heating circuit, DHW, and heat transfer</p>																								
<p>21</p>  <p>Mixed heating circuit, DHW, heat transfer, and burner</p>	<p>22</p>  <p>Mixed heating circuit, DHW, heat transfer and heat pump</p>	<p>23</p>  <p>Mixed heating circuit with unmixed heating circuit, solid fuel boiler</p>	<table border="1"> <tr> <td></td> <td>valve</td> <td></td> <td>exchanger</td> </tr> <tr> <td></td> <td>pump</td> <td></td> <td>mixing valve</td> </tr> <tr> <td></td> <td>sensor</td> <td></td> <td>energy source</td> </tr> <tr> <td></td> <td>heating circuit</td> <td></td> <td>heat pump</td> </tr> <tr> <td></td> <td>buffer storage</td> <td></td> <td>heating manifold</td> </tr> <tr> <td></td> <td>DHW storage</td> <td></td> <td></td> </tr> </table>		valve		exchanger		pump		mixing valve		sensor		energy source		heating circuit		heat pump		buffer storage		heating manifold		DHW storage		
	valve		exchanger																								
	pump		mixing valve																								
	sensor		energy source																								
	heating circuit		heat pump																								
	buffer storage		heating manifold																								
	DHW storage																										

LHCC: additional functions to expand preset schemes

The preset hydraulic schemes can be increased in a flexible and easy way, by means of free contacts. If the controller has several free outputs in comparison with the necessary schemes, the remaining free relays can be used to activate different additional functions. Some examples of the functions that can be managed by free relays:

System 1 +

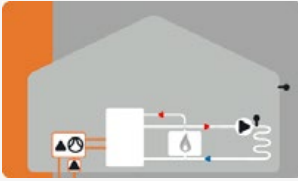

Combined storage with unmixed heating circuit **with additional functions glycol pump and compressor**

System 2 +

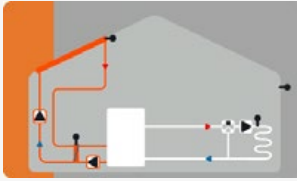

Combined storage with mixed heating circuit **with additional functions solar and heat exchangers**

System 8 +



Combined storage or buffer storage with mixed heating circuit **with additional function burner and boiler pump**

°Caleon Smart Room Controller

Stylish TFT capacitive touch panel for easy remote control of the heating system. Normal, Turbo, Eco and Off operation modes with specific temperature setpoint. Holiday program. Up to 8 adjustable daily heating time slot. CAN Bus connection for the system Connect. Data logging on MicroSD Card via data logger Connect.

Wi-Fi N 2.4 Ghz connection for remote control by °Caleon app

Main features

- For Weather-Compensated Heating Controllers 24VDC: MHCC and LHCC
- Room temperature sensor 0÷60°C, accuracy 0.1°C
- Relative humidity sensor 0÷100%, accuracy 0.1%
- Daily heating time slot: 8 for each room / area
- CAN Bus connection for the Connect system
- TFT Color display 2.8" with Glass front and Capacitive touch panel.
- Dimensions: 75 x 95 x 19 mm
- Power consumption: 0.5-1.0 W
- IP 20.



Code: **RC50**

AVAILABLE UNTIL SELL-OUT



Remote control by app
for smartphone and tablet



°Caleon Clima Smart Room Controller

Same features as Art. RC50 with additional cooling system Management (combined with LHCC controller).

Supplementary Features

- Cooling Mode
- Output: 2x 0-10V



Code: **RC55**

AVAILABLE UNTIL SELL-OUT



°Caleon Smart Thermostat

Elegant chrono-thermostat with TFT capacitive touch panel. Normal, Turbo, Eco and Off operation modes. Holiday program. Up to 8 daily heating time slots can be selected.

Wi-Fi N 2.4 Ghz connection for remote control by °Caleon app

Main features

- Room temperature sensor 0÷60°C, accuracy 0.1°C
- Relative humidity sensor 0÷100%, accuracy 0.1%
- 1 dry contact (or 230 VAC switching selectable by means of internal jumper)
- Daily heating slots: 8
- TFT Color display 2.8" with Glass front and Capacitive touch panel
- Dimensions: 75 x 95 x 19 mm
- Power supply 230 V AC
- Power consumption: max 2.5 W
- IP 20.



Code: **RC51**

AVAILABLE UNTIL SELL-OUT



Remote control by °Caleon app

°Caleon Room Controller and °Caleon Thermostat can be monitored and controlled remotely, via the internet, using the **dedicated app available for Android and Apple systems.** The application can monitor one or more °Caleon devices connected to the internet (Wi-Fi coverage is required in the installation rooms).

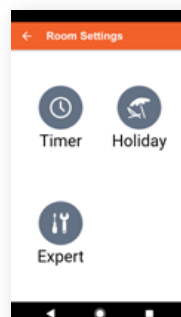
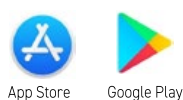

Functionality



Weekly time schedule



Management of multiple devices

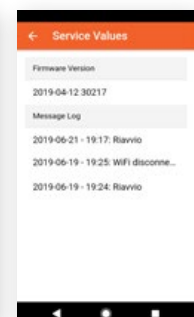

History of events. Log messages

M21D Actuator

3 point actuator for mixing valve. Bidirectional, reversible with fixed limit switches for an operating range of 90°. 2 min., torque: 5 Nm. Power supply 230V. IP42. Quick fixing system to the mixing valve.

Code: **M21D**

M41D Actuator

3 point actuator for mixing valve. Bidirectional, reversible with fixed limit switches for an operating range of 90°. 2 min., torque: 5 Nm. Power supply 24V AC. IP42. Quick fixing system to the mixing valve.

Code: **M41D**

M51D Proportional actuator

Proportional actuator for mixing valve. Control signal 0-10V / 2-10V - 0-20 mA / 4-20 mA. Bidirectional, reversible with fixed limit switches for an operating range of 90°. 1 min., torque: 5 Nm. Power supply 24V DC or 24V AC. IP42. Quick fixing system to the mixing valve.

Code: **M51-05D**



ACD10 Fixed temperature actuator

Actuator for mixing valve with electronic control of fluid temperature at fixed temperature. Bidirectional, reversible with switcher, limited operating range 90°; torque: 6 Nm. Power supply 230 V. Protection: IP42.

- Setting range of target temperature: 5 up to 90°C;
- Setup wizard on first start with a multilingual interface;
- 2 selectable hydraulic schemes;
- Reversible TFT 240x240 pixel display, with visualization of hydraulic scheme and main information;
- Selectable clockwise or anticlockwise direction of rotation in opening/closing;
- Personalized operative parameters;
- Heating or cooling working modes;
- Junction box for easy connection of the sensors;
- 1 Pt1000 deep sensor (ø5x40 mm, 1 m length, included) or with fixing kit to the pipe.
- Quick fixing system to the mixing valve.



Code: **ACD10**

AHD20 Advanced climatic controller with built-in actuator

Modern climatic controller with built-in actuator. It allows, through the choice of the desired climatic curve, an accurate control of the mixed circuit, optimizing the energy consumption.

Bidirectional, reversible with switcher actuator, limited operating range 90°, torque 6 Nm. Power supply 230 V. Protection: IP42.

Some of the main functions:

- Setup wizard on first start with a multilingual interface;
- 2 selectable hydraulic schemes;
- Reversible TFT 240x240 pixel display, with visualization of hydraulic scheme and main information;
- Heating or cooling working modes;
- Junction box for easy connection of the sensors;
- Weekly program with time bands, Party functions, Eco and Holiday mode;
- Summer/winter automatic selection;
- Temperature adjustment by means of climatic curves (0.2÷2.6);
- Heating circuit control with maximum temperature limit for underfloor heating systems;
- Antifreeze protection and anti-lock circulating pump function;
- Optimization of the regulation of system by means of RCD20 (optional);
- 2 Pt1000 deep sensor (ø5x40 mm, 1 m and 3 m length, included) or with fixing kit to the pipe;
- Outside temperature sensor included;
- Quick fixing system to the mixing valve.



Code: **AHD20**



RCD20 Remote control

RCD20 room unit is the remote control of the heating system, designed to select the room temperature and the operating mode of the climatic controller AHD20 in an easy and comfortable way. The best placing is in the centre of the house, where there are the most significant climatic conditions of the building. The wide backlit display shows information about the temperatures and the operating mode. Moreover it is possible to select personalized functions such as Party, Eco, DHW heating.

Some of the main functions

- Room heating control by means of the time planning set on the climatic controller;
- Setting of the daily temperature and night temperature reduction;
- Party and Eco functions with adjustable time length;
- Note of the user's request of intervention and of damages signal;
- Automatic pairing with climatic controller;
- Power supply through the bus connection to climatic controller;
- Dimensions: 81 x 81 x 24,5 mm.
- IP 20.



Code: **RCD20**



BRC thermostat

Bimetallic unipolar thermostat with contact on interruption or on switching. Fastening of thermostat is made by means of a spring clamp for a constant sealing which guarantees a very good adherence to the pipes. ENEC approval.

- Setting range: 20÷90°C;
- Differential: 8 ± 3 K (adjustable);
- Power on contacts: 16 (2.5) A / 250 VAC;
- Protection: IP20.

Code: **BRC**



Dip temperature sensor

Temperature sensor PT1000, in PVC, for climatic controllers. 4 m long.

Code: **TT/P4**



Temperature contact sensor

Temperature sensor PT1000, in PVC, for supply pipes, for climatic controllers. 4 m long.

Code: **TR/P4**



°Caleon Cable

Bus cable copper shielded for the connection of °Caleon room controller to the controller. 6 wire twisted pair: 3 x 2 x 0.22 mm². Available in lengths per meters.

Code: **CABLE-CALEON**



External temperature sensor

External temperature sensor PT1000 for climatic controller.

Code: **TA/55**



BRV ModvSol range, thanks to the versatility of ModvS, offers a complete range of pump units and accessories for solar systems.

In order to give a better service to our Customers, our products are tested and checked at our factory.

ModvSol stands out for ease and speed of installation.

The unit has a supply and a return way, it is preassembled and it is housed into an elegant insulation box. A special metal back plate allows a fast fitting to the wall or to a solar buffer tank.

The several models offer important advantages, such as a safety unit CE and TÜV approved, a pressure gauge specifically made for solar installations and a convenient flowmeter that allows easy commissioning of the system.

SOLAR THERMAL

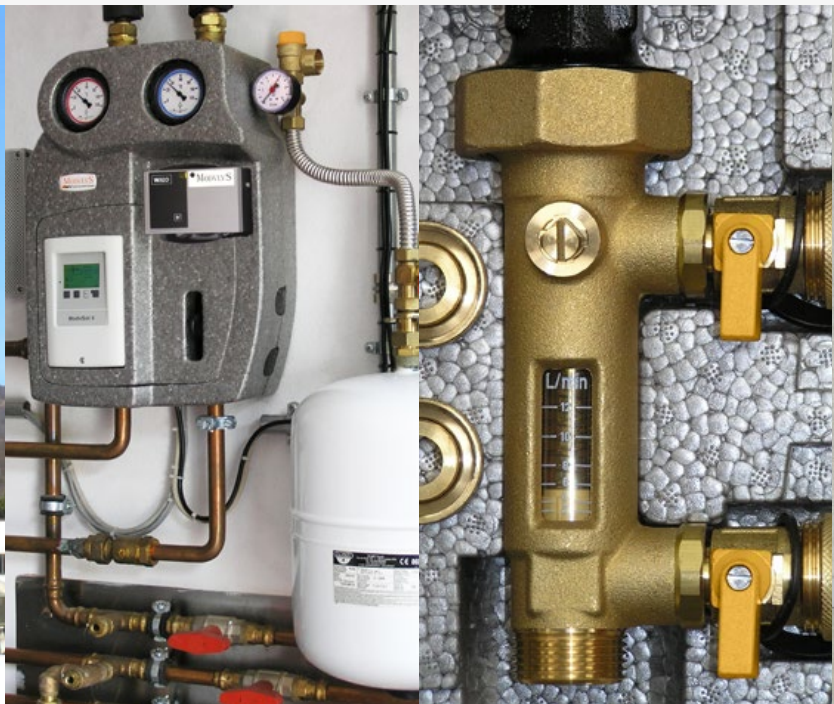

The flow regulator has the filling and draining valves very close to each other; this allows to minimize the residual air in circulation after the filling operations.

The ball valves before and after the circulating pump allow its easy removal without draining the system. All sealing joints are glycol resistant. The solar unit has a working temperature of 120°C and 160°C for a short time. Connections of different sizes are available.

The picture below shows a “pilot” installation with low voltage circulating pump.

The pump is powered by a PV panel and is completely autonomous energetically. It is used daily to check its functionality and it is installed in a company room available to customers and visitors.

The deaerator, standard on most models, continuously and effectively eliminates the air bubbles present in the circuit.

In fact when the heat-conducting fluid goes through the deaerator, the important difference of diameter between it and the remaining components of the circuit gives rise to a reduction of the speed of the circulation of the fluid, so helping the separation of the air bubbles that go towards the deaerator.

The constant search for quality led BRV to test the deaerator: Test report available on request.



Product installed in 2005 and working up to the present.

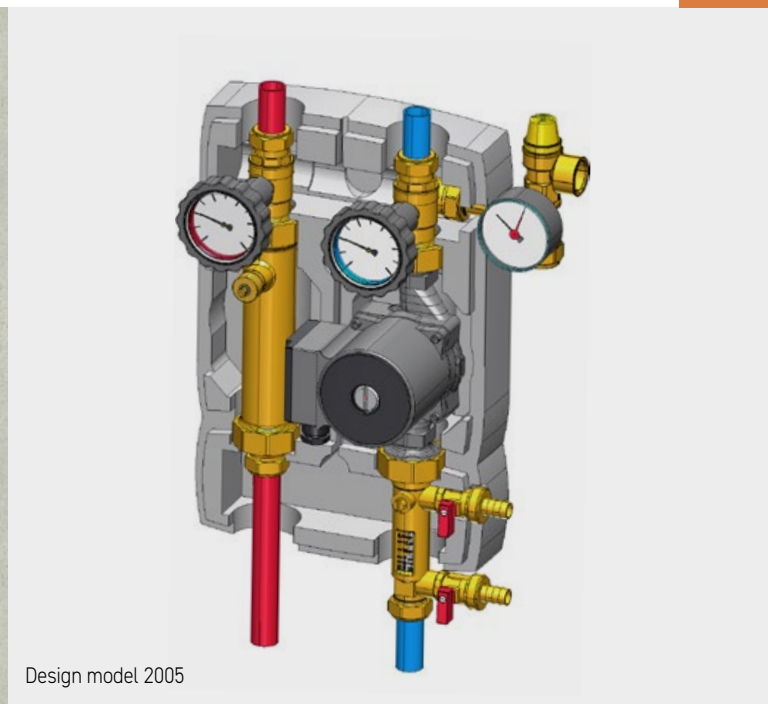

Design model 2005

Since 1999

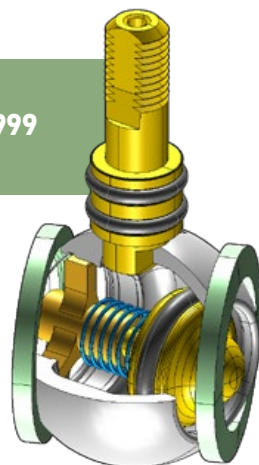

Supplied for the first time by BRV on the European market in 1999, the special “Solar” check valve mounted both in the supply and in the return way, prevents the migration of energy from the water tank to the solar collector in any working condition, together with very low headlosses with an advantage for the efficiency of the system.

It is also possible to exclude it in case of service (e.g. to drain the installation) by rotating the thermometer handle by 45°. Now the “Solar” ball, used all over the world by several manufacturers, is an important point of reference for many forced circulation solar thermal systems.

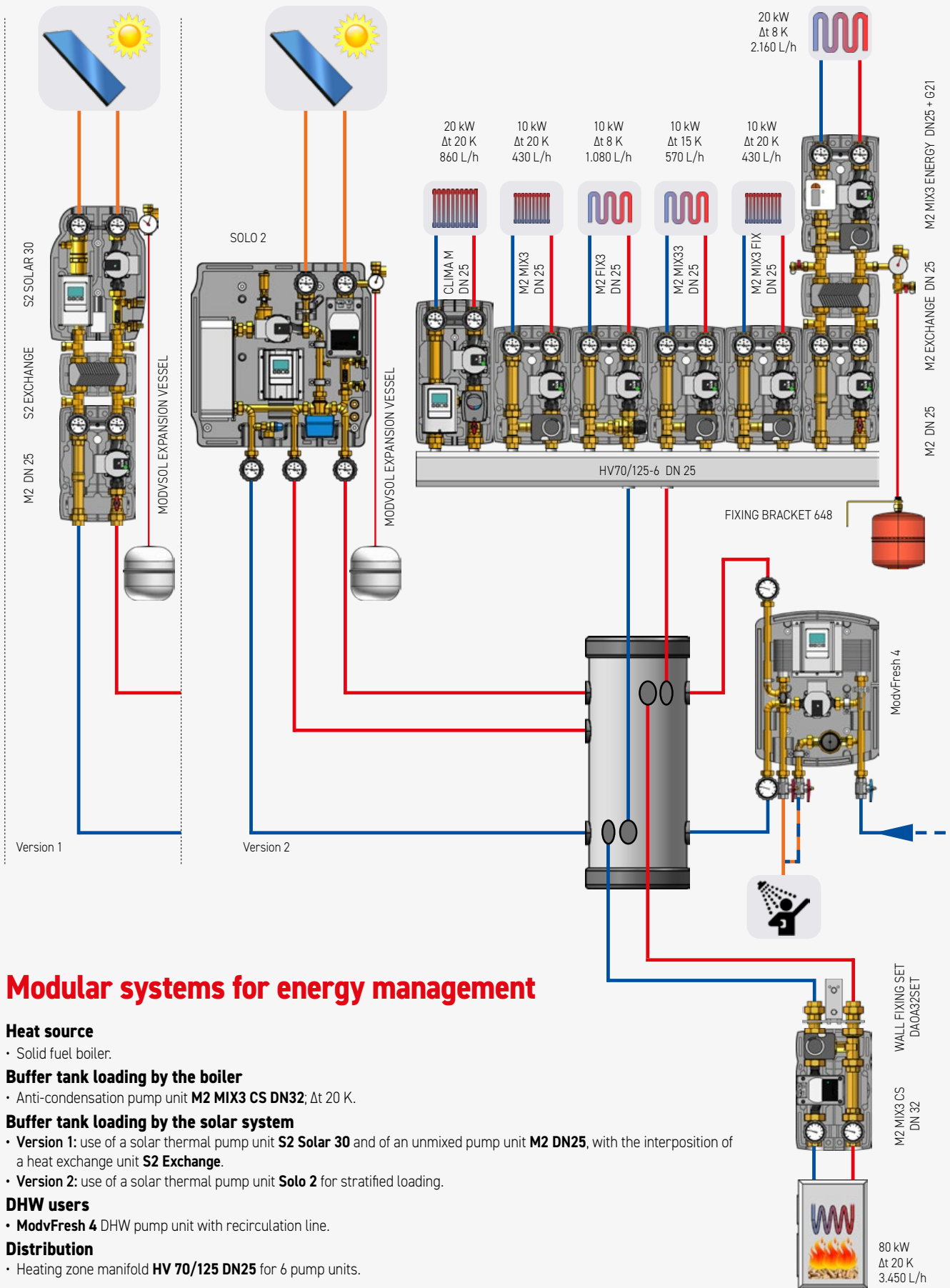

Modular systems for energy management

Heat source

- Solid fuel boiler.

Buffer tank loading by the boiler

- Anti-condensation pump unit **M2 MIX3 CS DN32**; Δt 20 K.

Buffer tank loading by the solar system

- **Version 1**: use of a solar thermal pump unit **S2 Solar 30** and of an unmixed pump unit **M2 DN25**, with the interposition of a heat exchange unit **S2 Exchange**.
- **Version 2**: use of a solar thermal pump unit **Solo 2** for stratified loading.

DHW users

- **ModvFresh 4** DHW pump unit with recirculation line.

Distribution

- Heating zone manifold **HV 70/125 DN25** for 6 pump units.

Note: the representations are to be considered just as an indication and they have no completeness pretension.

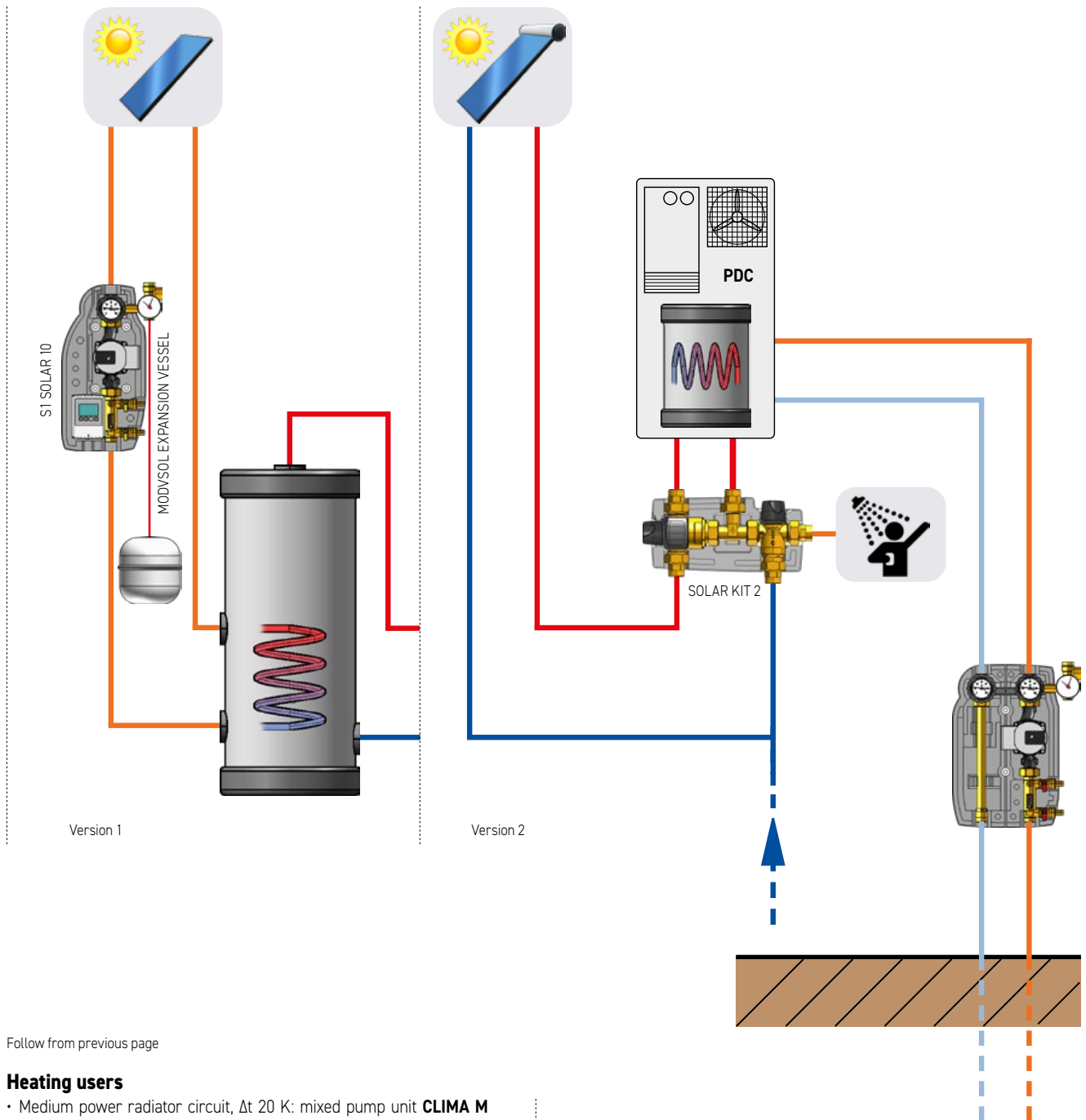

SOLAR THERMAL

Follow from previous page

Heating users

- Medium power radiator circuit, Δt 20 K: mixed pump unit **CLIMA M DN25**;
- Low power radiator circuit, Δt 20 K: mixed pump unit **M2 MIX3 DN25**;
- Low power underfloor heating circuit, Δt 8 K: fixed temperature pump unit **M2 FIX3 DN25**;
- Low power underfloor heating circuit, Δt 15 K: mixed pump unit **M2 MIX33 DN25**;
- Low power radiator circuit, Δt 20 K: mixed pump unit with electronic control for constant temperature **M2 MIX3 FIX DN25**;
- Medium power wall radiant heating circuit, Δt 8 K: use of a heat exchange unit **M2 Exchange** to separate hydraulically the user circuit (to keep the piping clean). Unmixed pump unit **M2 DN25** on the primary line and mixed pump unit **M2 MIX3 Energy DN25 with G21** on the secondary line, to meter the produced heat/cooling energy.

Modular systems for solar and geothermal energy

Heat source

- Solar and geothermal energy.
- **Version 1:** forced circulation solar thermal system with the use of a solar pump unit **S1 Solar 10** to load a DHW tank.
- **Version 2:** natural circulation solar installation with the use of solar collectors with DHW tank included.

Distribution

- **Solar Kit 1**, solar-boiler connection kit, for use of DHW.

Note: the representations are to be considered just as an indication and they have no completeness pretension.

SOLAR THERMAL

SOLAR PUMP UNITS UP TO 38 L/min

SINGLE LINE

S1 Solar 1

SINGLE LINE SOLAR PUMP UNIT

The unit with 1" (180 mm) solar circulating pump, fully assembled and tested, consists of:

Return

- Flowmeter with flow regulation with filling and draining valves.
- Synchronous solar high efficiency circulating pump with cables.
- Flanged 3-way ball valve with 10 mbar check valve (which can be excluded by rotating the handle by 45°) supplied with in-handle thermometer (blue ring, range 0°C-120°C).
- Safety unit 6 bar with ø50 mm 0-10 bar pressure gauge with 3/4" Male connection to the expansion vessel. End of drain side: 3/4" F.

EPP insulation box (Dimensions: 155x425x150 mm).

A special back plate fixes the unit to the insulation box and allows a quick fitting to the wall or to the storage tank.

PN 10. Constant temperature 120°C; (short time temperature: 160°C for 20 s).

External connections: 22 mm compression, 3/4" Male or 1" Male

FIELD OF USE

For power up to 50 kW



Code 22 mm: **122641R-xx-(PST6/PST8/US75)**
 Code 3/4" Male: **103641R-xx-(PST6/PST8/US75)**
 Code 1" Male: **104641R-xx-(PST6/PST8/US75)**



Available flowmeters:

06 = 1-6 l/min
12 = 2-12 l/min
28 = 8-28 l/min
38 = 8-38 l/min



Available circulating pumps:

Wilo Para ST 25/6 iPWM (**PST6**)
 Wilo Para ST 25/8 iPWM (**PST8**)
 Grundfos UPM3 Hybrid 25-70 (**US75**)



S1 Solar 10

SINGLE LINE SOLAR PUMP UNIT WITH BUILT-IN CONTROLLER

The unit with 1" (180 mm) solar circulating pump, fully assembled and tested, consists of:

Return

- Flowmeter with flow regulation with filling and draining valves.
- Synchronous solar high efficiency circulating pump.
- Flanged 3-way ball valve with 10 mbar check valve (which can be excluded by rotating the handle by 45°) supplied with in-handle thermometer (blue ring, range 0°C-120°C).
- Safety unit 6 bar with ø50 mm 0-10 bar pressure gauge with 3/4" Male connection to the expansion vessel. End of drain side: 3/4" F.

Solar controller ModvSol S pre-wired including 2 silicone sensors, to control basic systems with only one loop and one buffer tank. Controller power cable with Schuko plug. Power cable and PWM control cable for the circulating pump. As regards the technical features of the controller please see the dedicated section.

EPP insulation box (Dimensions: 215x440x150 mm).

A special back plate fixes the unit to the insulation box and allows a quick fitting to the wall or to the storage tank.

PN 10. Constant temperature 120°C; (short time temperature: 160°C for 20 s).

External connections: 22 mm compression, 3/4" Male or 1" Male.

FIELD OF USE

For power up to 50 kW



Code 22 mm: **122-xx-(PST6/PST8/US75)-STDC**
 Code 3/4" Male: **103-xx-(PST6/PST8/US75)-STDC**
 Code 1" Male: **104-xx-(PST6/PST8/US75)-STDC**



Available flowmeters:

06 = 1-6 l/min
12 = 2-12 l/min
28 = 8-28 l/min
38 = 8-38 l/min



Available circulating pumps:

Wilo Para ST 25/6 iPWM (**PST6**)
 Wilo Para ST 25/8 iPWM (**PST8**)
 Grundfos UPM3 Hybrid 25-70 (**US75**)



Available controllers:
 ModvSol S (**STDC**)

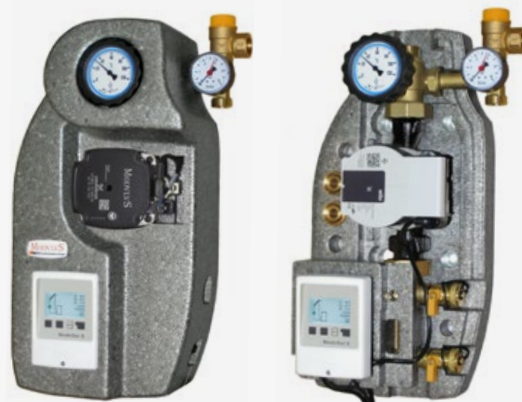

Code composition: the suffix "xx" shows the flow, followed by the circulating pump (e.g. **122641R-12-PST6**) and, where present, by the controller model.

S1 Solar 10 T
SINGLE LINE SOLAR PUMP UNIT WITH
BUILT-IN CONTROLLER AND THERMOSTAT FUNCTION

The unit with 1" (180 mm) solar circulating pump, fully assembled and tested, consists of:

Return

- Flowmeter with flow regulation with filling and draining valves.
- Synchronous solar high efficiency circulating pump.
- Flanged 3-way ball valve with 10 mbar check valve (which can be excluded by rotating the handle by 45°) supplied with in-handle thermometer (blue ring, range 0°C-120°C).
- Safety unit 6 bar with ø50 mm 0-10 bar pressure gauge with 3/4" Male connection to the expansion vessel. End of drain side: 3/4" F.

Solar controller ModvSol S+T pre-wired including 3 silicone sensors, for the control of solar systems, with supplement to the tank, thanks to the thermostat function. Pre-wired control unit with external power box designed for powering the control unit and connection to the relay managing the supplement (boiler, pump or valve, electric resistance max. 3 kW)

EPP insulation box (Dimensions: 215x440x150 mm).

A special back plate fixes the unit to the insulation box and allows a quick fitting to the wall or to the storage tank.

PN 10. Constant temperature 120°C; (short time temperature: 160°C for 20 s).

External connections: 22 mm compression, 3/4" Male or 1" Male.

FIELD OF USE

For power up to 50 kW



Code 22 mm: **122-xx-PST(6/8)-S+T**
 Code 3/4" Male: **103-xx-PST(6/8)-S+T**
 Code 1" Male: **104-xx-PST(6/8)-S+T**



Available flowmeters:

- 06** = 1-6 l/min
- 12** = 2-12 l/min
- 28** = 8-28 l/min
- 38** = 8-38 l/min



Available circulating pumps:

- Wilo Para ST 25/6 iPWM (**PST6**)
- Wilo Para ST 25/8 iPWM (**PST8**)



Available controllers:

- ModvSol S+T (**S+T**)



ModvSol S+T hydraulic schemes

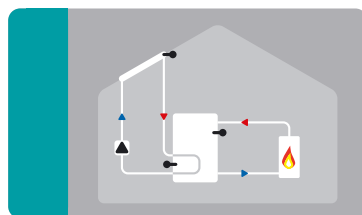

Solar with supplement
(boiler or pump/valve)

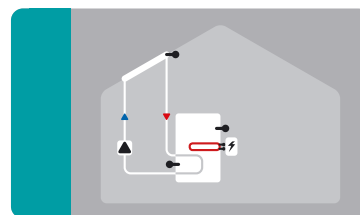

Solar with electrical supplement

SOLAR THERMAL

SOLAR PUMP UNITS UP TO 38 L/min

TWIN LINE

S2 Solar 2

TWIN LINE SOLAR PUMP UNIT

The unit with 1" (180 mm) solar circulating pump, fully assembled and tested, consists of:

Return

- Flowmeter with flow regulation with filling and draining valves.
- Synchronous solar high efficiency circulating pump with cables.
- Flanged 3-way ball valve with 10 mbar check valve (which can be excluded by rotating the handle by 45°) supplied with in-handle thermometer (blue ring, range 0°C-120°C).
- Safety unit 6 bar with ø50 mm 0-10 bar pressure gauge with 3/4" Male connection to the expansion vessel. End of drain side: 3/4" F.

Supply

- Ball valve with compression fitting and 10 mbar check valve (which can be excluded by rotating the handle by 45°) supplied with in-handle thermometer (red ring, range 0°C-120°C).
- Pipe with end connection.

Centre distance 125 mm. EPP insulation box (Dimensions: 277x425x150 mm). A special back plate fixes the unit to the insulation box and allows a quick fitting to the wall or to the storage tank.

PN 10. Constant temperature 120°C; (short time temperature: 160°C for 20 s).

External connections: 22 mm compression, 3/4" Male or 1" Male.

FIELD OF USE

For power up to 50 kW



Code 22 mm: **322647AR-xx-(PST6/PST8/US75)**
 Code 3/4" Male: **303647AR-xx-(PST6/PST8/US75)**
 Code 1" Male: **304647AR-xx-(PST6/PST8/US75)**



Available flowmeters:

06 = 1-6 l/min
12 = 2-12 l/min
28 = 8-28 l/min
38 = 8-38 l/min



Available circulating pumps:

Wilo Para ST 25/6 iPWM (**PST6**)
 Wilo Para ST 25/8 iPWM (**PST8**)
 Grundfos UPM3 Hybrid 25-70 (**US75**)



S2 Solar 20

TWIN LINE SOLAR PUMP UNIT WITH BUILT-IN CONTROLLER

The unit with 1" (180 mm) solar circulating pump, fully assembled and tested, consists of:

Return

- Flowmeter with flow regulation with filling and draining valves.
- Synchronous solar high efficiency circulating pump.
- Flanged 3-way ball valve and 10 mbar check valve (which can be excluded by rotating the handle by 45°) supplied with in-handle thermometer (blue ring, range 0°C-120°C).
- Safety unit 6 bar with ø50 mm 0-10 bar pressure gauge with 3/4" Male connection to the expansion vessel. End of drain side: 3/4" F.

Supply

- Ball valve with compression fitting with 10 mbar check valve (which can be excluded by rotating the handle by 45°) supplied with in-handle thermometer (red ring, range 0°C-120°C).
- Pipe with end connection.

Solar controller ModvSol M pre-wired including 3 silicone sensors to control systems with 2 loops and 1 or 2 buffer tanks. Controller power cable with Schuko plug. Power cable and PWM control cable for the circulating pump. As regards the technical features of the controller please see the dedicated section.

Centre distance 125 mm. EPP insulation box (Dimensions: 308x434x169 mm). A special back plate fixes the unit to the insulation box and allows a quick fitting to the wall or to the storage tank.

PN 10. Constant temperature 120°C; (short time temperature: 160°C for 20 s).

External connections: 22 mm compression, 3/4" Male or 1" Male.



Code 22 mm: **322-xx-(PST6/PST8/US75)-M3S**
 Code 3/4" Male: **303-xx-(PST6/PST8/US75)-M3S**
 Code 1" Male: **304-xx-(PST6/PST8/US75)-M3S**



Available flowmeters:

06 = 1-6 l/min
12 = 2-12 l/min
28 = 8-28 l/min
38 = 8-38 l/min



Available circulating pumps:

Wilo Para ST 25/6 iPWM (**PST6**)
 Wilo Para ST 25/8 iPWM (**PST8**)
 Grundfos UPM3 Hybrid 25-70 (**US75**)



Available controllers:

ModvSol M (**M3S**)

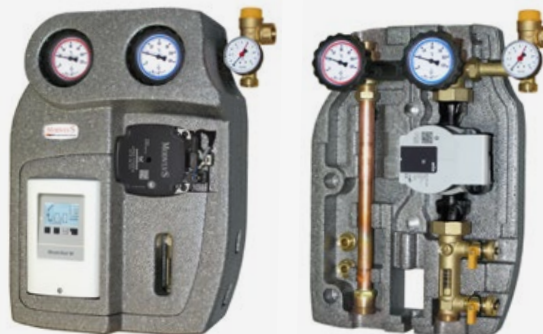

FIELD OF USE

For power up to 50 kW

Code composition: the suffix "xx" shows the flow, followed by the circulating pump (e.g. **322647AR-12-PST6**) and, where present, by the controller model.

S2 Solar 3

TWIN LINE SOLAR PUMP UNIT WITH DEAERATOR

The unit with 1" (180 mm) solar circulating pump, fully assembled and tested, consists of:

Return

- Flowmeter with flow regulation with filling and draining valves.
- Synchronous solar high efficiency circulating pump with cables.
- Flanged 3-way ball valve with 10 mbar check valve (which can be excluded by rotating the handle by 45°) supplied with in-handle thermometer (blue ring, range 0°C-120°C).
- Safety unit 6 bar with ø50 mm 0-10 bar pressure gauge with 3/4" Male connection to the expansion vessel. End of drain side: 3/4" F.

Supply

- Flanged ball valve with 10 mbar check valve (which can be excluded by rotating the handle by 45°) supplied with in-handle thermometer (red ring, range 0°C-120°C).
- Deaerator made of brass provided with manual bleeder.
- Pipe with end connection.

Centre distance 125 mm. EPP insulation box (Dimensions: 277x425x150 mm). A special back plate fixes the unit to the insulation box and allows a quick fitting to the wall or to the storage.

PN 10. Constant temperature 120°C; (short time temperature: 160°C for 20 s).

External connections: 22 mm compression, 3/4" Male or 1" Male.

FIELD OF USE

For power up to 50 kW



Code 22 mm: **322651AR-xx-(PST6/PST8/US75)**
Code 3/4" Male: **303651AR-xx-(PST6/PST8/US75)**
Code 1" Male: **304651AR-xx-(PST6/PST8/US75)**



Available flowmeters:

06 = 1-6 l/min
12 = 2-12 l/min
28 = 8-28 l/min
38 = 8-38 l/min



Available circulating pumps:

Wilo Para ST 25/6 iPWM (**PST6**)
Wilo Para ST 25/8 iPWM (**PST8**)
Grundfos UPM3 Hybrid 25-70 (**US75**)



S2 Solar 30

TWIN LINE SOLAR PUMP UNIT WITH DEAERATOR AND BUILT-IN CONTROLLER

The unit with 1" (180 mm) solar circulating pump, fully assembled and tested, consists of:

Return

- Flowmeter with flow regulation with filling and draining valves.
- Synchronous solar high efficiency circulating pump.
- Flanged 3-way ball valve with 10 mbar check valve (which can be excluded by rotating the handle by 45°) supplied with in-handle thermometer (blue ring, range 0°C-120°C).
- Safety unit 6 bar with ø50 mm 0-10 bar pressure gauge with 3/4" Male connection to the expansion vessel. End of drain side: 3/4" F.

Supply

- Flanged ball valve with 10 mbar check valve (which can be excluded by rotating the handle by 45°) supplied with in-handle thermometer (red ring, range 0°C-120°C).
- Deaerator made of brass provided with manual bleeder.
- Pipe with end connection.

Solar controller ModvSol M pre-wired including 3 silicone sensors to control systems with 2 loops and 1 or 2 buffer tanks. Controller power cable with Schuko plug. Power cable and PWM control cable for the circulating pump. As regards the technical features of the controller please see the dedicated section.

Centre distance 125 mm. EPP insulation box (Dimensions: 308x434x169 mm). A special back plate fixes the unit to the insulation box and allows a quick fitting to the wall or to the storage tank.

PN 10. Constant temperature 120°C; (short time temperature: 160°C for 20 s).

External connections: 22 mm compression, 3/4" Male or 1" Male.



Code 22 mm: **322D-xx-(PST6/PST8/US75)-M3S**
Code 3/4" Male: **303D-xx-(PST6/PST8/US75)-M3S**
Code 1" Male: **304D-xx-(PST6/PST8/US75)-M3S**



Available flowmeters:

06 = 1-6 l/min
12 = 2-12 l/min
28 = 8-28 l/min
38 = 8-38 l/min



Available circulating pumps:

Wilo Para ST 25/6 iPWM (**PST6**)
Wilo Para ST 25/8 iPWM (**PST8**)
Grundfos UPM3 Hybrid 25-70 (**US75**)



Available controllers:

ModvSol M (**M3S**)

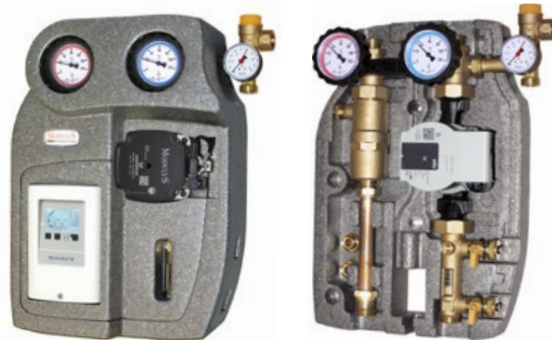

FIELD OF USE

For power up to 50 kW

Code composition: the suffix "xx" shows the flow, followed by the circulating pump (e.g. **322651AR-28-PST6**) and, where present, by the controller model.

SOLAR THERMAL

SOLAR PUMP UNITS UP TO 40 L/min

ENERGY METERING

S2 Solar 30L

TWIN LINE SOLAR PUMP UNIT WITH DEAERATOR AND BUILT-IN CONTROLLER WITH ADVANCED FUNCTIONS

The unit with 1" (180 mm) solar circulating pump, fully assembled and tested, consists of:

Return

- Flowmeter with flow regulation with filling and draining valves.
- Synchronous solar high efficiency circulating pump.
- Flanged 3-way ball valve with 10 mbar check valve (which can be excluded by rotating the handle by 45°) supplied with in-handle thermometer (blue ring, range 0°-120°C).
- Safety unit 6 bar with ø50 mm 0-10 bar pressure gauge with 3/4" male connection to the expansion vessel. End of drain side: 3/4" F.

Supply

- Flanged ball valve with 10 mbar check valve (which can be excluded by rotating the handle by 45°) supplied with in-handle thermometer (red ring, range 0°-120°C).
- Deaerator made of brass provided with manual bleeder.
- Pipe with end connection.

Solar controller ModvSol L pre-wired including 3 silicone sensors, to control complex systems with 3 loops ad 1 up to 3 buffer tanks. Controller power cable with Schuko plug. Power cable and PWM control cable for the circulating pump. As regards the technical features of the controller please see the dedicated section.

Center Distance 125 mm. EPP insulation box (Dimensions: 308x434x169 mm). A special back plate fixes the unit to the insulation box and allows a quick fitting to the wall or to the storage tank.

PN 10. Constant temperature 120°C; (short time temperature: 160°C for 20 s).

External connections: 22 mm compression, 3/4" Male or 1" Male.

Code composition: the suffix "xx" shows the flow, followed by the circulating pump and by the controller model (e.g. **303D-28-PST6-L3S**).



Code 22 mm: **322D-xx-(PST6/PST8/US75)-L3S**
 Code 3/4" Male: **303D-xx-(PST6/PST8/US75)-L3S**
 Code 1" Male: **304D-xx-(PST6/PST8/US75)-L3S**



Available flowmeters:

06 = 1-6 l/min
12 = 2-12 l/min
28 = 8-28 l/min
38 = 8-38 l/min



Available circulating pumps:

Wilo Para ST 25/6 iPWM (**PST6**)
 Wilo Para ST 25/8 iPWM (**PST8**)
 Grundfos UPM3 Hybrid 25-70 (**US75**)



Available controllers:

ModvSol L (**L3S**)

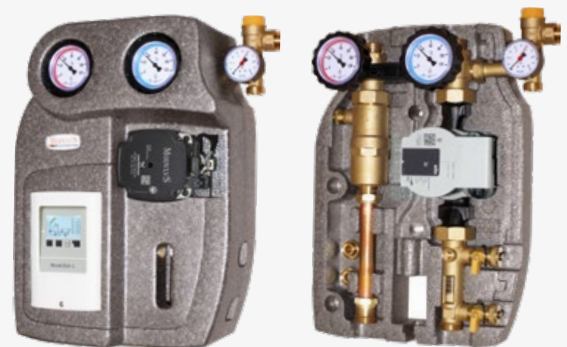

FIELD OF USE
 For power up to 50 kW

S2 Solar 30L VFS

TWIN LINE SOLAR PUMP UNIT WITH DEAERATOR AND BUILT-IN CONTROLLER WITH ADVANCED FUNCTIONS AND ENERGY METERING

The pump unit, supplied with 1" synchronous solar high efficiency circulating pump (180 mm) fully assembled and tested, is different from the model S2 Solar 30L in the VFS digital sensor (flow 2-40 L/min) suitable to count simultaneously the flow and the return way temperature. These data, together with those supplied by an additional supply contact sensor (TR/S1), allow the ModvSol L controller to count the energy produced by the solar system and to "certify" the thermic efficiency. In that way it'll be possible to get government loans and incentives.

PN 10. Constant temperature 120°C; (short time temperature: 160°C for 20 s).

Return way: the record of the temperature is made between 0°C and 100°C. (A short time up to +120°C, during which the VFS is not recording the temperature, is allowed).

External connections: 22 mm compression, 3/4" Male or 1" Male.

Display of the solar energy produced by the solar system:

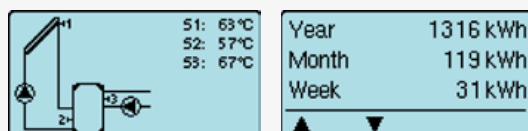

Code 22 mm: **322D-40-PST8-L4S**
 Code 3/4" Male: **303D-40-PST8-L4S**
 Code 1" Male: **304D-40-PST8-L4S**



Available flowmeters:

40 = VFS 2-40 l/min



Available circulating pumps:

Wilo Para ST 25/8 iPWM (**PST8**)



Available controllers:

ModvSol L (**L4S**)



On demand, a test report of the VFS is available. It shows the result of the tests made directly in the Grundfos Lab.



3/4" connection to fit between the flexible hose and the expansion vessel. It is possible to fill the installation trough the side valve.

S2 Solar 2
TWIN LINE SOLAR PUMP UNIT
FOR HIGH FLOW SYSTEMS

The unit with 1" (180 mm) solar circulating pump, fully assembled and tested, consists of:

Return

- Flowmeter with flow regulation 5-42 L/min or 20-70 L/min.
- Synchronous solar high efficiency circulating pump.
- Flanged ball valve with check valve 18 mbar (the valve can be excluded by rotating the handle by 45°) supplied with in-handle thermometer (blue ring, range 0-120°C).
- "T" connection for safety unit.
- Safety unit 6 bar with $\varnothing 50$ mm 0-10 bar pressure gauge with 3/4" male connection to the expansion vessel. End of drain side: 1" F.

Supply

- "T" connection with sensor holder pit $\varnothing 6$ mm.
- Flanged ball valve with check valve 18 mbar (the valve can be excluded by rotating the handle by 45°) supplied with in-handle thermometer (red ring, range 0-120°C).
- Pipe with end connection.

Center Distance 125 mm. EPP insulation box (Dimensions: 285x500x170 mm). A special metallic back plate fixes the unit to the insulation box and allows a quick fitting to the wall or to the solar buffer tank.

PN 10. Constant temperature 120°C (short time temperature: 160°C for 20 s).

External connections: 1"1/4 Male, 1"1/2 Male or 1" pipe union Female.

FIELD OF USE

For power up to 100 kW



Code 1" Femmina: **304F647-xx-PA1-8**
 Code 1"1/4 Male: **305647-xx-PA1-8**
 Code 1"1/2 Male: **306647-xx-PA1-8**



Available flowmeters:
42 = 5-42 l/min
70 = 20-70 l/min



Available circulating pumps:
 Wilo Para Maxo 25-180-08 (**PA1-8**)



SOLAR THERMAL

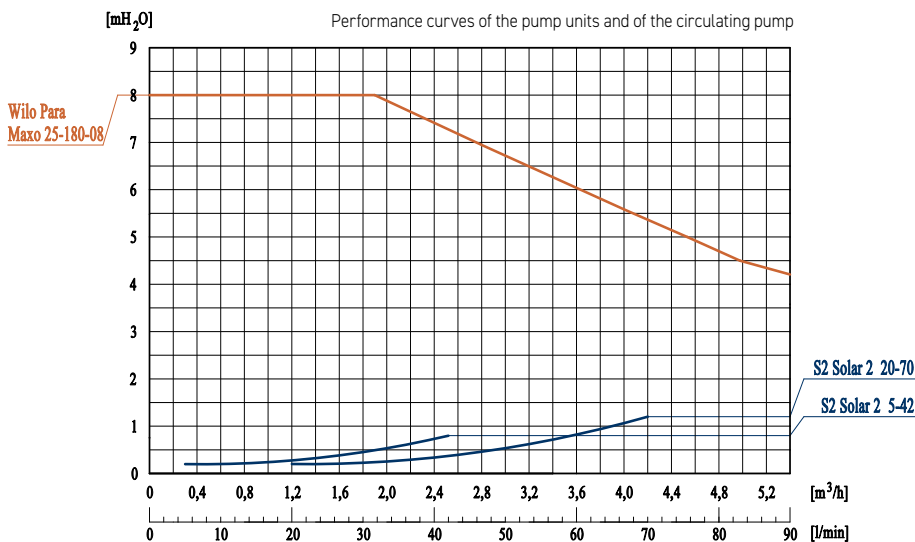

Art. 525 ISO

Ball valve in hot forged brass to fill and drain solar thermal systems.
 For more information please refer to pages dedicated to ModvSol "Equipments and accessories".

Code composition: the suffix "xx" shows the flow.

SOLAR THERMAL

SOLAR PUMP UNITS UP TO 28 L/min DRAIN-BACK

S2 Solar 20 Drain-Back

TWIN LINE SOLAR PUMP UNIT FOR DRAIN-BACK APPLICATIONS WITH BUILT-IN CONTROLLER AND HIGH EFFICIENCY SOLAR CIRCULATING PUMP

The unit with 1" (180 mm) solar circulating pump, fully assembled and tested, consists of:

Return

- Flowmeter with flow regulation with filling and draining valves.
- Synchronous solar high efficiency circulating pump.
- Flanged 3-way ball valve with side 3rd port capped (can be used for additional connections), supplied with in-handle thermometer (blue ring, range 0°-120°C).

Supply

- Ball valve with compression fitting, supplied with in-handle thermometer (red ring, range 0°-120°C).
- Pipe with end connection.

Pre-wired ModvSol M or ModvSol L solar controller including 3 silicone sensors. Controller power cable with Schuko plug. Power cable and PWM control cable for the circulating pump. As regards the technical features of the controller please see the dedicated section.

Centre Distance 125 mm. EPP insulation box (Dimensions: 308x434x169 mm) A special metallic back plate fixes the unit to the insulation box and allows a quick fitting to the wall or to the solar buffer tank.

PN 10. Constant temperature 120°C; (short time temperature: 160°C for 20 s).

External connections: 22 mm compression, 3/4" Male or 1" Male.



Code 22 mm: **422-xx-PST(8/13)-(M3S/L3S)**
 Code 3/4" Male: **403-xx-PST(8/13)-(M3S/L3S)**
 Code 1" Male: **404-xx-PST(8/13)-(M3S/L3S)**



Available flowmeters:
06 = 1-6 l/min
12 = 2-12 l/min
28 = 8-28 l/min



Available circulating pumps:
 Wilo Para ST 25/8 iPWM (**PST8**)
 Wilo Para ST 15/13 iPWM (**PST13**)



Available controllers:
 ModvSol M (**M3S**)
 ModvSol L (**L3S**)



SOLAR THERMAL

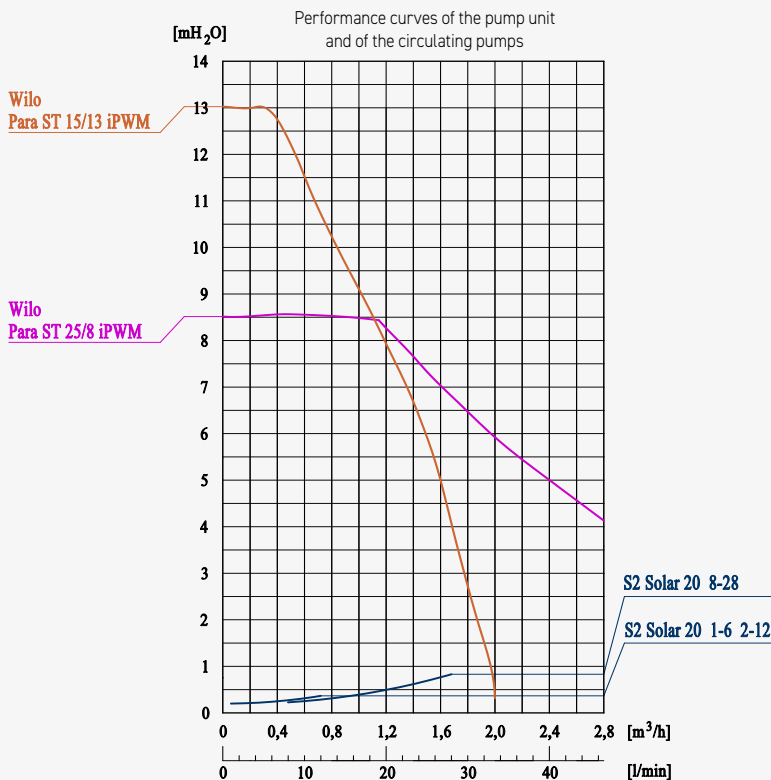
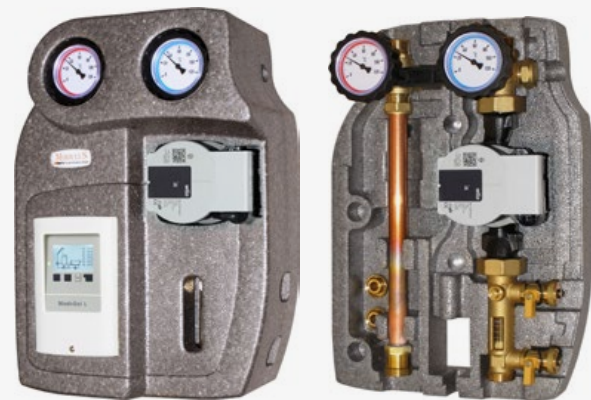

Circulating Pump

High Efficiency: Wilo Para ST iPWM with a permanent magnet motor. The pump uses synchronized electronic communication and it saves on power consumption by matching the output of the pump with the needs of the solar circuit.

Sole circulating pump. Thanks to the high head produced by the Wilo Para ST 15/13 iPWM, just a single circulating pump is enough to carry out the functions of filling the circuit and flowing the fluid through the solar panels. The ModvSol L controller fills the system quickly by exploiting the pump's high head and the circuit's low flow rates. In cases where an initial high head is not required but the overall system requires the head also at higher flow rates then it is recommended to use the Wilo Para ST 25/8 iPWM pump instead. It is important that the size of pump is accurately assessed in combination with the overall solar thermal system.



Code composition: the suffix "xx" shows the flow, followed by the circulating pump and the controller (e.g. **403-12-PST8-L3S**).

Operating principle

Once there is enough solar radiation and the buffer tank is able to get additional heat, the controller first switches on the circulating pump. The first phase lasts a number of minutes, (this time can be set depending on features of the plant), where the controller uses the high head of the pump to fill the circuit by pushing water directly into the solar panels. The second phase, following a short transition period, sees the controller using the pump as it would a pump in any standard pressurized solar thermal system. However, thanks to the high efficiency of the pump, the electricity consumption is much lower than a standard system.

The system works in an unpressurized state and as a result the following components are not required – pressure safety valve, solar pressure gauge, expansion vessel, check valves and manual deaerator. When the target temperature is reached, or in the case of there not being enough solar radiation, the controller stops fluid circulation and the circuit empties back to the drain-back tank.

Advice for correct operation

To enable proper draining of the system, suitably designed solar panels must be installed with a minimum slope of 2 cm/m towards the panel return pipe that is located in the bottom part of the solar collectors. In addition, all pipes must have a minimum slope of 5 cm/m towards the drain-back tank.

The drain-back tank must have an air volume of at least 1.5 times the part of the air volume of loop overlooking the tank (including solar panels); it must be positioned at a height that is lower than the height of the solar panels to ensure complete draining of the circuit.



Warning: The drain-back tank must have an air volume of at least 1.5 times the part of the air volume of loop overlooking the tank (including solar panels). The solar pump must be positioned at a height that is always lower than the drain-back tank so as to prevent pump starvation.

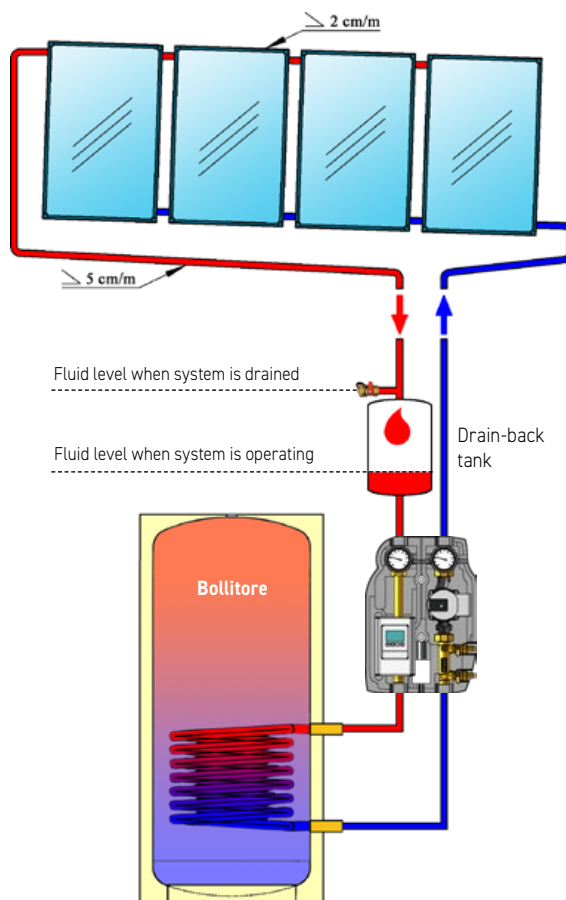

SOLAR THERMAL

ModvSol M and Modvsol L controllers

The ModvSol differential temperature controllers have, as current specification, all the functions necessary to manage a high efficiency circulating pump in a drain-back installation.

- Regulation of pump operation using synchronized PWM signal;
- User setting of solar loop filling time;
- User setting of complete cycle period;
- User setting of target temperatures.

The ModvSol L controller has more additional functions than the version ModvSol M: for more information please refer to the section "Differential solar controllers".



Temperature sensors and cables for high efficiency circulating pumps

PT1000 temperature sensors

Temperature sensors with PT1000 sensor elements with guaranteed accuracy of detection, according to DIN EN60751 (IEC751); they ensure a precise acquisition of the temperature and an excellent exploitation of the energy.



TT/S2

Deep temperature sensor with silicone cable 2 m long, 180°C.

Code: **TT/S2**

TT/T2,5

Deep temperature sensor with special Teflon cable 2.5 m long, 220°C (short time 300°C).

Code: **TT/T2.5**

Power supply and PWM control cables for solar circulating pumps

Wilo Para



Power supply cable for Wilo Para circulating pumps. Length: 1 m.

Code: **CAVOCIRC-A**

PWM control cable for Wilo Para circulating pumps. Length: 1 m.

Code: **PRESAPR71B**

Grundfos UPM3 / Wilo Para Maxo

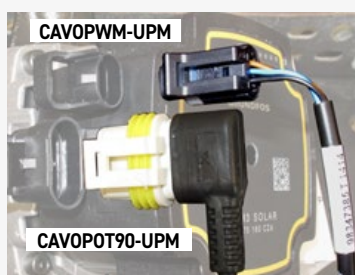

Power supply cable for Grundfos UPM3 Hybrid, UPM3S and Wilo Para Maxo circulating pumps. Length: 1 m.

Code: **CAVOPOT90-UPM**

PWM control cable for Grundfos UPM3 Hybrid and Wilo Para Maxo circulating pumps. Length: 1 m.

Code: **CAVOPWM-UPM**

ModvSol S controller (pre-wired)

Compact differential temperature controller to control basic solar systems with only one loop and 1 buffer tank.

9 hydraulic schemes

Connections:

- 3 inputs for PT 1000 temperature sensors;
- 1 230V output relay with changover contact;
- 1 PWM-10V output for high efficiency circulating pumps.

Supplied pre-wired with the solar pump unit in this configuration:

- 2 Pt1000 silicone temperature sensors (TT/S2) 2 m length;
- 2 control cables for circulating pump: power supply and PWM signal;
- power supply cable with Schuko plug.

S+T version has also the "thermostat function" (2 relays and 3 PT1000 sensors).



Outlets (Out)

- 1 relay 230V
- 1 PWM / 0-10V output



Inputs (In)

- 3 Pt1000 sensors



Supplied pre-wired with the solar pump unit

ModvSol M controller

Differential temperature controller to manage solar systems with 3 loops and 1 or 2 buffer tanks. Possibility to increase the preset schemes, with the activation of additional functions, by means of free unemployed relays.

Connect system: data logging on MicroSD card for data backup and analysis, connection to local network by means of CAN-Bus or Ethernet (Data logger Connect is required).

More than 25 hydraulic schemes

Connections:

- 4 inputs for PT1000 sensors;
- 2 outputs relays 230 V;
- 1 PWM-10V output for high efficiency circulating pumps;
- External connection by means of CAN-Bus or Ethernet.

Supplied into an individual packing that includes:

- 3 PT1000 silicone temperature sensors (TT/S2) 2 m length.

Supplied pre-wired with the solar pump unit in this configuration:

- 3 PT1000 silicone temperature sensors (TT/S2) 2 m length;
- 2 control cables for circulating pump: power supply and PWM signal;
- Power supply cable with Schuko plug.



Supplied into an individual packing

Code: **MTDC.SET3**



Outlets (Out)

- 2 relays 230V
- 1 PWM / 0-10V output



Inputs (In)

- 4 Pt1000 sensors



ModvSol L controller

Differential temperature controller to manage complex solar systems with 3 loops and 1 up to 3 buffer tanks. Possibility to increase the preset schemes, with the activation of additional functions, by means of free unemployed relays. Monitoring of flow and pressure by means of VFS and RPS sensors.

Connect system: data logging on MicroSD card for data backup and analysis, connection to local network by means of CAN-Bus or Ethernet (Data logger Connect is required).

More than 41 hydraulic schemes

Connections:

- 6 inputs for PT1000 temperature sensors;
- 2 inputs for VFS and RPS sensors;
- 3 outputs relays 230V, one with changover contact;
- 2 PWM-10V outputs for high efficiency circulating pumps;
- External connection by means of CAN-Bus or Ethernet.

Supplied into an individual packing that includes:

- 4 PT1000 silicone temperature sensors (TT/S2) 2 m length.

Supplied pre-wired with the solar pump unit in this configuration:

- 3 PT1000 silicone temperature sensors (TT/S2) 2m length; 4 PT1000 silicone temperature sensors in the version with VFS;
- 2 control cables for circulating pump: power supply and PWM signal;
- Power supply cable with Schuko plug.



Supplied into an individual packing

Code: **LTDC.SET4**



Outlets (Out)

- 3 relays 230V
- 2 PWM / 0-10V outputs



Inputs (In)

- 6 Pt1000 sensors
- 2 VFS o RPS sensors



Different hydraulic schemes ModvSol S, ModvSol M and ModvSol L

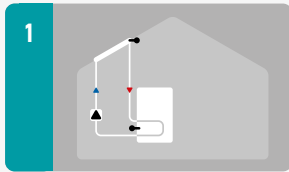

1 Solar + buffer tank

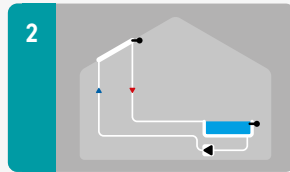

2 Solar + swimming pool

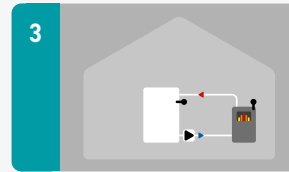

3 Solid fuel boiler + buffer tank

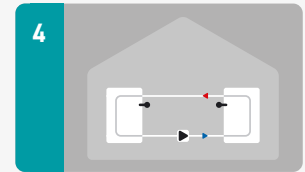

4 Buffer tank loading

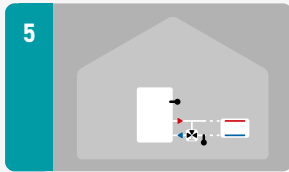

5 Return temperature increase



6 Thermostat function



7 Universal ΔT

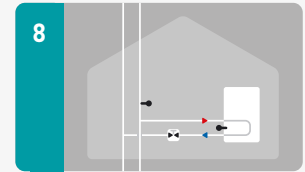

8 Shutting valve

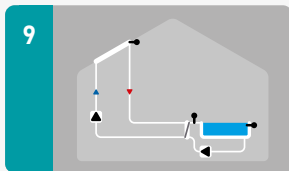

9 Solar + heat exchanger (sensor on secondary) + swimming pool

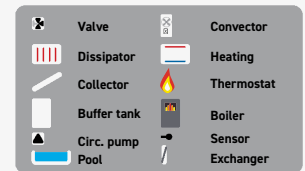

Different hydraulic schemes ModvSol M and ModvSol L

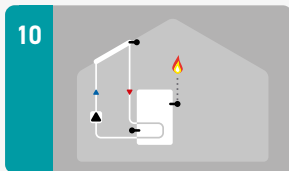

10 Solar + thermostat (supplementary heating)

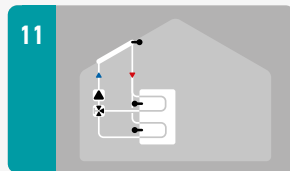

11 Solar + 2 levels buffer tank

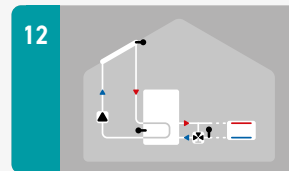

12 Solar + heating system

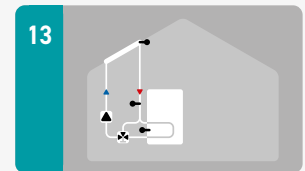

13 Solar + by-pass

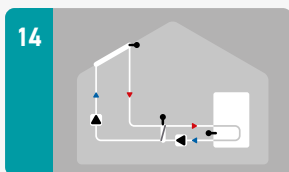

14 Solar + heat exchanger

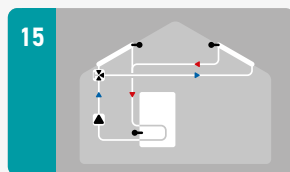

15 Solar + 2 collectors

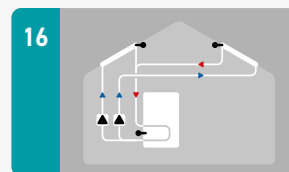

16 Solar + 2 collectors and 2 pumps

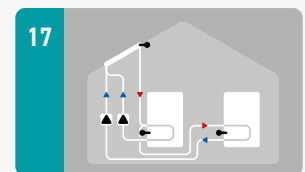

17 Solar + 2 buffer tanks and 2 pumps

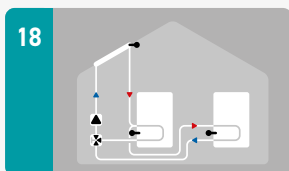

18 Solar + 2 buffer tanks and valve

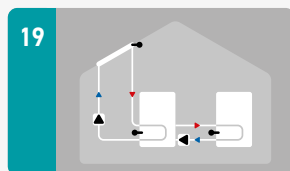

19 Solar + buffer tank loading

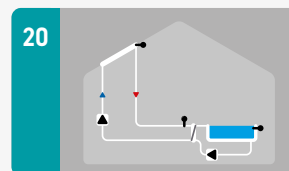

20 Solar + swimming pool and heat exchanger

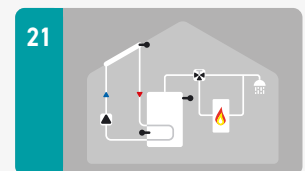

21 Solar + thermostat and valve

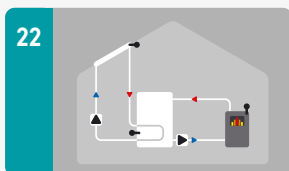

22 Solar + solid fuel boiler

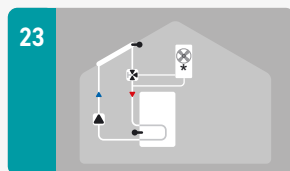

23 Solar + cooling 1 (collector cooling)

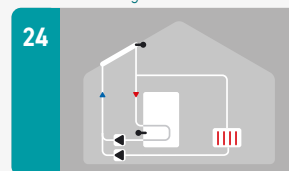

24 Solar + cooling 2 (collector cooling)

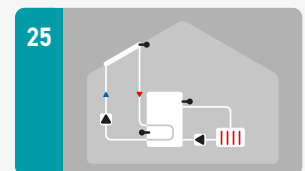

25 Solar + cooling 3 (collector cooling)



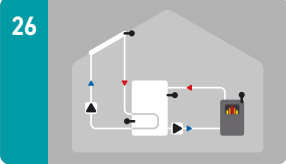
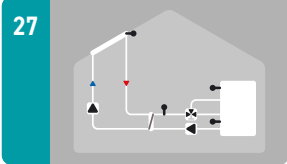
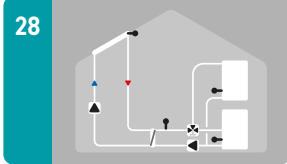
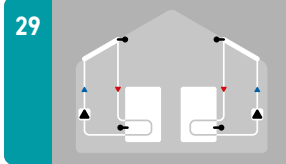
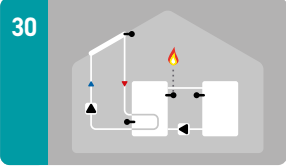
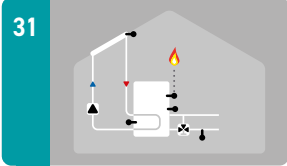
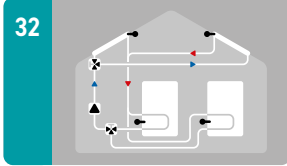
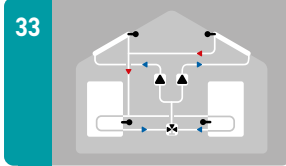
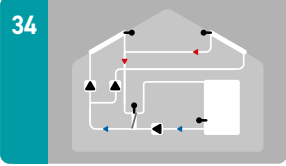
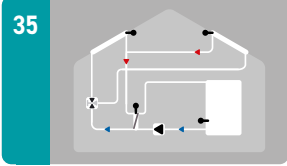
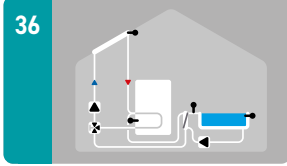
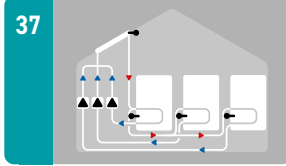
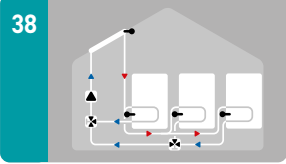
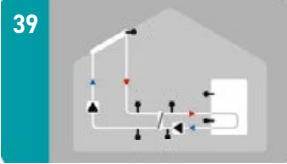
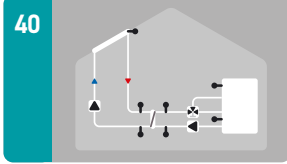
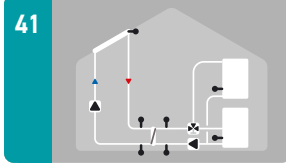











Different hydraulic schemes ModvSol L







<p>26</p>  <p>Solar + buffer tank and solid fuel boiler</p>	<p>27</p>  <p>Solar + heat exchanger and zone valve</p>	<p>28</p>  <p>Solar + heat exchanger and 2 buffer tanks</p>	<p>29</p>  <p>2x solar</p>
<p>30</p>  <p>Solar + thermostat and buffer tank loading</p>	<p>31</p>  <p>Solar + thermostat and return temperature increase</p>	<p>32</p>  <p>Solar + 2 collectors, 2 buffer tanks, 2 valves</p>	<p>33</p>  <p>Solar + 2 collectors, 2 buffer tanks, 2 pumps</p>
<p>34</p>  <p>2x Solar with storage, heat exchanger and 3 pumps</p>	<p>35</p>  <p>2x Solar with storage, heat exchanger and valve</p>	<p>36</p>  <p>Solar + swimming pool, buffer tank, heat exchanger and valve</p>	<p>37</p>  <p>Solar + 3 buffer tanks and 3 pumps</p>
<p>38</p>  <p>Solar + 3 buffer tanks and 2 valves</p>	<p>39</p>  <p>Solar with storage and heat exchanger for large systems</p>	<p>40</p>  <p>Solar with storage, heat exchanger and valve for large systems</p>	<p>41</p>  <p>Solar with 2 storages, heat exchanger and valve for large systems</p>

SOLAR THERMAL

The preset hydraulic schemes of **ModvSol M** and **Modvsol L** controllers can be increased in a flexible and easy way, by means of free contacts. If the controller has several free outputs in comparison with the necessary schemes, the remaining free relays can be used to activate different additional functions. User is guided step by step to set the correspondent parameters. Complementary functions can be managed by the same relay. The sensors too can be used for several complementary functions. In this way user can set up its own system in an easy and fast way.

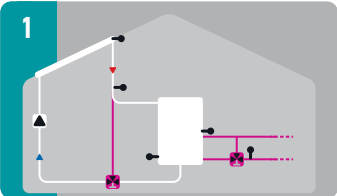
Functions that can be managed by free relays:

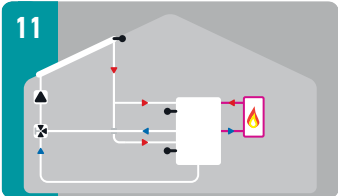
- | | | |
|--|--|--|
|  Differential temp. |  Always on |  Anti legionnaire's disease |
|  Heating system |  Cooling |  Return temp. increase |
|  Heat transfer |  Solid fuel boiler |  Booster pump |
|  Error message |  Parallel working with R1 or R2 |  Solar by-pass |
|  Additional heating |  Pressure control |  Collector field cooling |

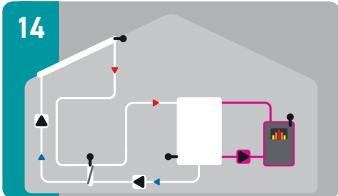
<p>System 1 +  + </p>  <p>Solar + buffer tank with additional solar by-pass function and return temperature increase.</p>	<p>System 11 + </p>  <p>Solar + 2 levels buffer tank and diverting valve with additional thermostat function.</p>	<p>System 14 + </p>  <p>Solar + heat exchanger with additional solid fuel boiler function.</p>
---	--	---

Art. 520 Solar

F/F ball valve in hot forged brass for solar installations. Yellow finish.
Ends threaded to ISO 228 (DIN 259 BSP 2779).
Provided with steel handle yellow PVC covered.

PN 10. Constant temperature 120°C; (short time temperature 160°C for 20 sec).
Available sizes: 3/4", 1" and 1 1/4".

Code 3/4": **03520SOL**
Code 1": **04520SOL**
Code 1 1/4": **05520SOL**



The 620 series valves, specifically developed for use in solar systems, are equipped with the renowned "Solar" ball, a distinctive element of ModvSol pump units. The ball is appreciated on the market thanks to its careful design that allows a perfect seal and low headlosses. The particular profile of the shutter allows the check valve to be blocked in the open position for system drainage or maintenance operations.

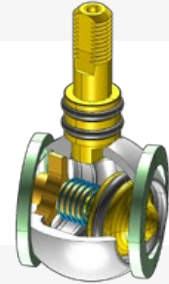

Art. 620 ISO

VALVE WITH SOLAR BALL

F/F ball valve in hot forged brass for solar installations. Yellow finish.
Ends threaded to ISO 228 (DIN 259 BSP 2779).
Provided with insulation T-handle with flow direction indication.
The check valve can be excluded by rotating the handle by 45°.

PN 10. Constant temperature 120°C; (short time temperature 160°C for 20 sec).
Available sizes: 3/4" and 1".

Code 3/4": **03620ISO**
Code 1": **04620ISO**



Art. 620 TER

VALVE WITH SOLAR BALL AND THERMOMETER

F/F ball valve in hot forged brass for solar installations. Yellow finish.
Ends threaded to ISO 228 (DIN 259 BSP 2779).
Supplied with in-handle thermometer, red ring (range 0°C-120°C, TER-R) and blue ring (range 0°C-120°C, TER-B) with flow direction indication.
The check valve can be excluded by rotating the handle by 45°.

PN 10. Constant temperature 120°C; (short time temperature 160°C for 20 sec).
Available sizes: 3/4" and 1".

Code 3/4": **03620TER-(R/B)**
Code 1": **04620TER-(R/B)**



620TER-R



620TER-B

Headlosses curves

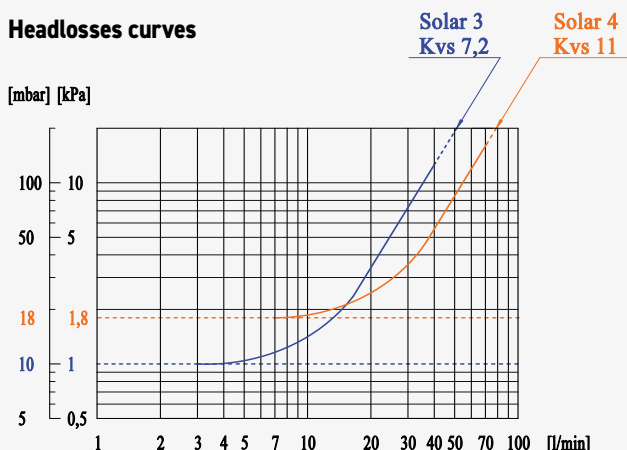

Solar 3 ball

3/4" - DN20
Kvs: 7,2

Minimum check valve opening pressure:
10 mbar

Solar 4 ball

1" - DN25
Kvs: 11

Minimum check valve opening pressure:
18 mbar

Art. 690
SOLAR SAFETY VALVE

Membrane valve for solar thermal systems, for power up to 50 kW.
CE marking according to Directive 97/23/CE. TÜV certified.
Made to work at high temperature with glicole fluid (max. 50%).
Setting pressure: 6 bar.
Working temperature: from -20°C up to +160°C.

Available sizes: 1/2" x 3/4"



Individual packing code: **02690-03**
Multiple packing code: **02690-030EM**

Art. 525 ISO
FILLING/DRAINING VALVE

Ball valve in hot forged brass to fill and drain solar thermal systems.
One-piece-body provided with two side 3/4" hose union valves with plug.
DN20, flow rate up to 70 L/min.
End thread 1" Female to ISO 228 (DIN 259 BSP 2779).
Supplied with insulating T handle.

PN 10. Constant temperature 120°C; (short time temperature: 160°C for 20 s).
External connections: 1" Female x 1" Female, 15 mm, 18 mm, 22 mm
and 28 mm for copper pipe with adapters.
Kvs Value: 17.0



Code 15 mm: **15525ISO**
Code 18 mm: **18525ISO**
Code 22 mm: **22525ISO**
Code 28 mm: **28525ISO**
Code 1": **04525ISO**

Art. 654 Adapters for capillary welding

The set consists of 3/4" nut, welding connection for copper pipe 15 mm
and fiber plain gasket.

Code for pipe 15 mm: **03654SET**

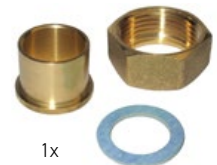

The set consists of 1" nut, welding connection for copper pipe 22 mm
and fiber plain gasket.

Code for pipe 22 mm: **04654SET**

Reduction adapter set for copper pipe

The set consists of 4 nuts and 4 adapter connections for the reduction from
22 mm to 18 mm or 15 mm compression.

Code 15 mm: **AJCA43SET**
Code 18 mm: **AJCA44SET**



Adapter set from 3/4" to 1"

The set consists of 4 adapters 3/4" F x 1" M and 4 fiber gaskets.
Yellow brass finish.

Code: **CYNV04SET**



Set nut 1 1/2" and EPDM gasket

Special gasket specific for solar intallations.
Yellow brass finish.

Code: **AYHT26SET**



Deaerator

Deaerator made of brass to be used in forced circulation solar thermal systems. The air separator divides the air into the thermo-conveyer fluid and then it can be purged by means of an automatic air-vent valve to be connected to the 3/8" female threaded end. It is suitable for the wall fastening by means of a threaded plug M8.

PN 6. Constant temperature 150°C.

Available connections: 22 mm compression and 3/4" Male.



Code 22 mm: **2277851**

Code 3/4" Male: **0377851**

Flexible set for the expansion vessel

DN15 AISI 304 stainless steel flexible hose (0.3 mm thickness) to connect the expansion vessel to the safety unit.
Ends threaded 3/4" nut x 3/4" nut.
The set includes: flexible pipe and fiber sealing joint.

Available lengths: 50 cm and 100 cm.



Code Flexible kit 3/4" x 3/4" - 50 cm: **FLEX0350SETB**

Code Flexible kit 3/4" x 3/4" - 100 cm: **FLEX03100SETB**

Air-vent valve

Automatic air-vent valve provided with isolating valve suitable for forced circulation solar thermal systems. Body made of brass. The plastic components are high temperature resistant (PPSU).
3/8" male connection provided with EPDM O-Ring gasketed.

The automatic air-vent valve, once operations to fill the system have been completed, must be isolated from the circuit, by closing the ball valve.

PN 6. Constant temperature 150°C.

Connection: 3/8" Male.



Code: **0177996**

Connection set of the expansion vessel

Connection set of the expansion vessel to the system. Thanks to the two check valves it is possible to disconnect without draining the system and the expansion vessel.



Code: **03648SET**

Fixing bracket for the expansion vessel with connector

"L" bracket to fix the expansion vessel to the wall.

The 3/4"M x 3/4"F connector is provided with a double check valve made of brass to replace the expansion vessel without draining the system.

The wall plugs and the packing are also included.

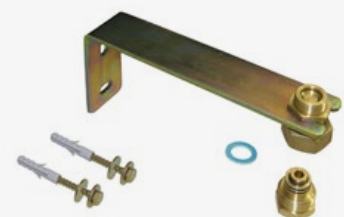

Code: **DA0ASOLVE**

Set ModvSol pressure expansion vessel with fixing bracket

Pressure expansion vessel suitable for solar systems, in compliance with the European Directive 97/23/CE about pressure devices (PED).

Provided with special antiscala SBR rubber bladder, which separates the "air" side from the "liquid" side. Formed in inox steel, with anticorrosive treatment of the internal surface of the "liquid" side.

The set is consists of:

- ModvSol pressure expansion vessel, capacity 8 L, 18 L o 24 L, with water inlet connection situated into the upper part and turned towards the height;
- "L" bracket to fix the expansion vessel to the wall;
- 3/4"M x 3/4"F connector provided with a double check valve made of brass to replace the expansion vessel without draining the system;
- Wall plugs and packing.

Maximum pressure 8 bar, 3 bar precharged.

Working temperature: from -10°C up to 110°C.

Maximum constant temperature for the membrane: 100°C.



Code Capacity 8 L: **SETVEMODVSOL8**
Code Capacity 18 L: **SETVEMODVSOL18**
Code Capacity 24 L: **SETVEMODVSOL24**



Art. 1090 3-WAY ZONE VALVE

Motorized 3-way zone valve with spring return for closed hydraulic systems. Suitable for: heating, cooling and solar thermal (glycol max 50%).

- Power supply: 230 VAC, 50 Hz. Absorbed power 6 W;
- Protection: IP22;
- Nominal pressure: PN 10;
- Room temperature: Max. 60°C;
- Fluid temperature: 5÷120°C; short time: 150°C;
- Nominal opening time: 20 s. Springclosing: 6 s.

Available external connections: 1" Male flat sealing.



Kvs: 12,6

Differential pressure: max. 0,63 bar



Without power:

AB → B



Code: **041090**

Main components and operation principle

Flowmeter: it allows to adjust the flow to the requirements of the installation, by a 3-way ball valve. If the valve is in closed position the flow is cut off, and it is possible to use the side tap to fill the plant. There is also another side tap, to drain the plant. The proximity of the two taps helps these operations minimizing the distance between the filling and the draining. The flow rate is measured and shown by the special sliding cursor: the feedback is immediate thanks to the proximity to the regulation valve. The flowmeter, and consequently the pump unit, must only be mounted in a vertical position.

SOLAR THERMAL

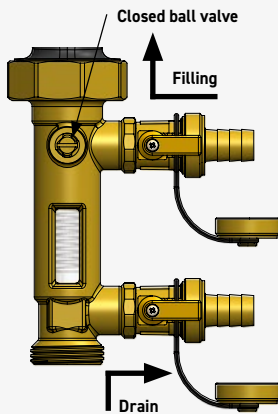

(1) - Filling/draining the installation

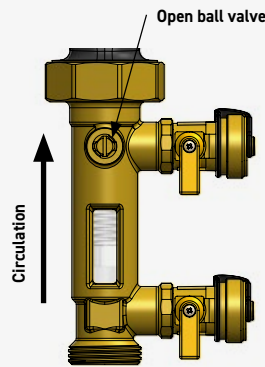

(2) - Starting the installation. To avoid any casual opening of the side valves, it is better to lock the levers in the close position, as shown here aside.

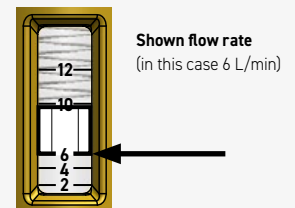
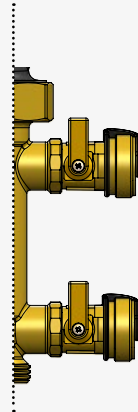

(3) - The flow rate is shown taking as reference the lower edge of the sliding cursor (see picture).

The integrated ball valve also allows fine adjustment of the system flow rate. However, it is recommended and preferable to adjust the flow rate by controlling the high efficiency synchronous circulating pump.

Solar checkball

It is built into the ball valve. It ensures the seal and low head losses. To exclude the checkball valve, for instance in case of system drainage, rotate the handle by 45° clockwise.

Safety unit

The safety unit, CE and TÜV certified, protects the system from overpressures. It is calibrated at 6 bar, over this pressure the unit comes into operation. It is also provided with a pressure gauge and with a connection to the expansion vessel by a 3/4" flexible kit.

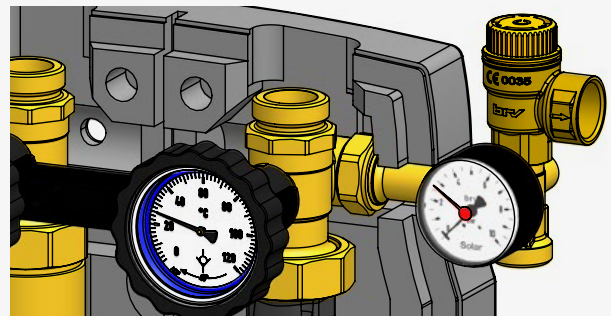

Model with deaerator

The deaerator is a device that separates continuously the air that is possibly in circulation together with the fluid. The air goes to the upper part of the deaerator and can be eliminated through the special bleeder while the system is working. Unscrew the knurled metal ring lock for not more than half turn. This operation has to be done at intervals.

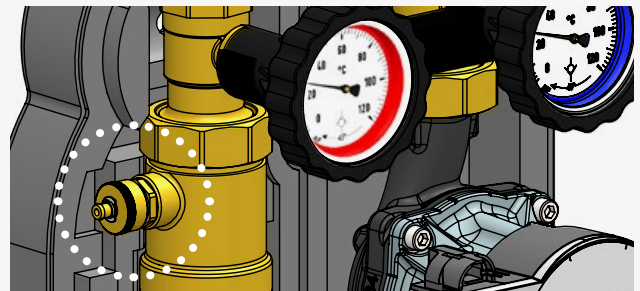

Warning: to avoid any leakage of the fluid, taking into consideration the very high working temperature, we recommend to fasten a pipe to the end of the bleeder.



The incessant search for the quality pushed BRV to make a test of the deaerator. Test report available on request.

A careful design has made it possible to reduce the head losses due to the deaerator, obtaining a Kvs equal to 14.

The design of a solar thermal system

The size of a solar system is fundamentally different from the size of a traditional heating system. The sun does not supply the whole necessary energy: only a part of it. A proper energy storage will make up for the lacking of irradiation during the short periods, while during the long periods it will be necessary to turn to an auxiliary heat source. It is important to know which part of the thermic requirement the solar installation is able to satisfy. The part of the usable energy collected depends on several parameters, first of all on the efficiency of the solar collectors.

This efficiency is related to the features of the collector (optical properties, insulation), to the temperature of utilization, to the inclination and the orientation of the collector, to the incoming solar radiation, to the outside temperature, to the speed of the wind. The efficiency of the solar collector is determined as the ratio between the usable energy collected Fr and the solar radiation cutting on the plane I_{β} .

The usable energy can be calculated as the difference between the absorbed and the lost energy, taking into consideration the product transmissibility-absorption $\tau\alpha$ and the coefficient of thermic leakage Uc .

In conclusion the instantaneous efficiency of a solar collector can be couched in that way:

$$\eta = Fr(\tau\alpha) - \frac{Fr(T_i - T_a)}{I_{\beta}}$$

where T_i is the inlet fluid temperature and T_a is the ambient temperature.
All the collectors are tested under working conditions and the testing points are transferred on the diagram:

$$\left(\frac{T_i - T_a}{I_{\beta}} ; \eta \right)$$

By connecting the points we obtain the instantaneous efficiency straight line (Draw. 1)

Draw. 1 - Efficiency straight line of the zone manifold

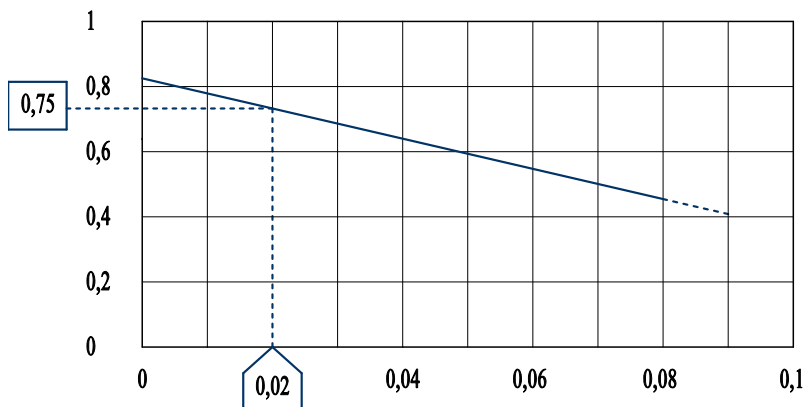

$$\frac{T_i - T_a}{I_{\beta}} \left[\frac{m^2 K}{W} \right]$$

The incoming solar radiation on the collector directed towards the equator and inclined of a β angle can be calculated as 800 W/m^2 (* see notes). From the diagram it is clear that, T_a being equal (e.g. 10°C) and T_i being low (e.g. 26°C), the efficiency is:

$$\frac{26 - 10}{800} = 0,02 \longrightarrow \eta = 0,75$$

otherwise, being the T_i high (e.g. 80°C) $\eta \cong 0,4$.

(*) Note: The density of the average power of the solar radiation outside the earth's atmosphere is about 1367 W/m^2 . On the earth's surface the maximum power is hardly ever more than 1100 W/m^2 , owing to the filter effect of the atmospheric components (gas, vapour, atmospheric dust) that absorb and disperse a part of the energy. More realistically, in the sizings, it is usual to assume from an average limit radiation of 800 W/m^2 up to a maximum limit radiation of 1000 W/m^2 , taking into consideration several pejorative factors that can reduce the radiation absorbed by the solar collector.

Obviously there are two working points with very different efficiencies. For this reason it is necessary to take into consideration an intermediate working point (by convention $0,04 \rightarrow \eta \cong 0,62$ as shown in draw. 1). According to these remarks the energy, that is really tapped from the fluid and brought to the installation, is only the 62% (Draw. 2).

Draw. 2 - Picture of a solar installation

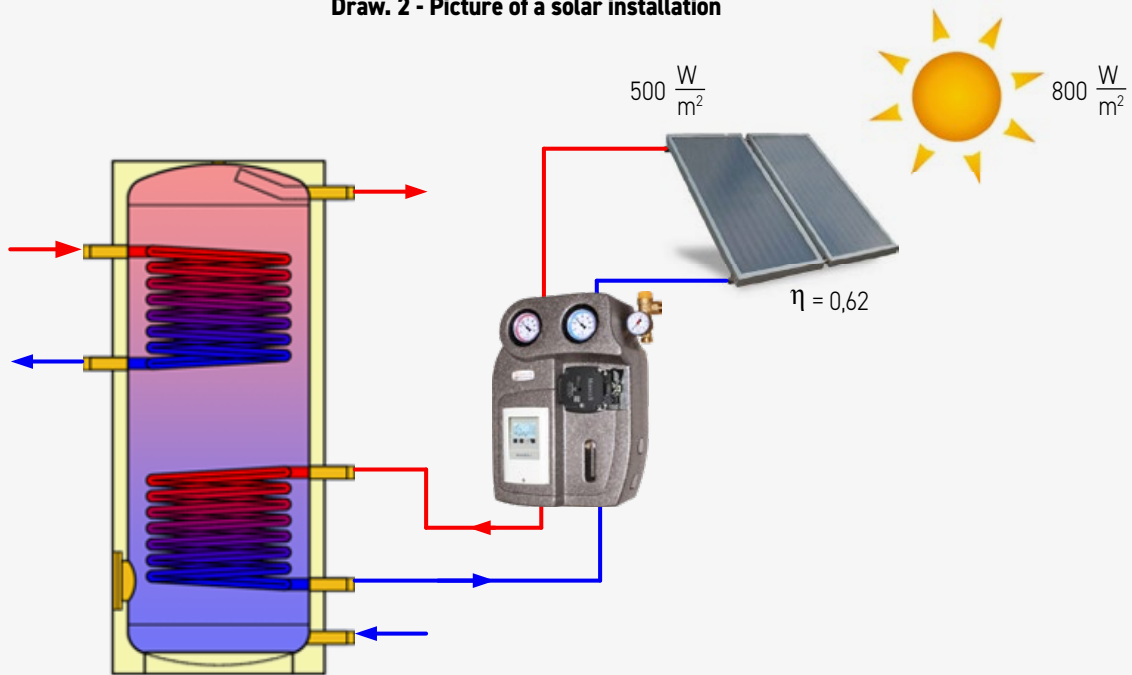

Therefore the solar collector must provide a thermic capacity qa of above 500 W every m^2 of tapping surface. It is advisable that, at the outlet of the collector the temperature Tu is not 6-9 K more than the inlet temperature. If we consider that the specific heat of the fluid is equal to $c=4000 \text{ J/kg K}$ the flow rate of the collector is:

$$qm = \frac{qa \times 60}{c \times \Delta t} = \frac{400 \times 60}{4000 \times 9} \cong 0,7 \text{ l/min} \cdot m^2$$

Our solar pump units are provided with six different models of flowmeter: for small size installations 1÷6 L/min and 2÷12 L/min (0.36 m^3/h and 0.72 m^3/h); for medium size installations 8÷28 L/min and 8÷38 L/min (1.7 m^3/h and 2.3 m^3/h); for high flow installations 5÷42 L/min and 20÷70 L/min (2.5 m^3/h and 4.2 m^3/h). To make an example, in the first case it is possible to install up to 8.5 m^2 of solar collectors, in the second case up to 17 m^2 , etc.

In designing a solar system it is very important to calculate the headlosses caused by the friction resistance of the fluid. It is necessary to know the headlosses of all the components of the installation. More than the solar pumping station we must take into consideration the heat exchanger inside the buffer tank, the solar collectors and the pipe fittings. The headlosses are connected to the flow rate.

If for example we consider an installation of 22.5 m^2 . Therefore qt is: $qt = 16 \text{ l/min} \cong 1000 \text{ kg/h}$. Considering this datum the headlosses will be the following.

As concerns the headlosses of the heat exchanger, the manufacturer should give this value.

In the absence of definite data, taking into consideration a coil of proper size (section and length) we can consider the following $\Delta ps = 200 \text{ mm H}_2\text{O}$.

The same for the solar collectors: even for them we consider a headloss of about 75 mm/m^2 . Therefore: $\Delta pc = 75 \times 22,5 = 1600 \text{ mm H}_2\text{O}$.

The headlosses due to the pipe fittings, if for instance there is a copper pipe 22×1 on two lengths of 20 m each, are easily calculable by using the diagram of the Draw. 3, taking into consideration an increase of 25%, due to localized headlosses (bends and all kinds of pipe fittings).

Draw. 3 - Headlosses of the copper pipes

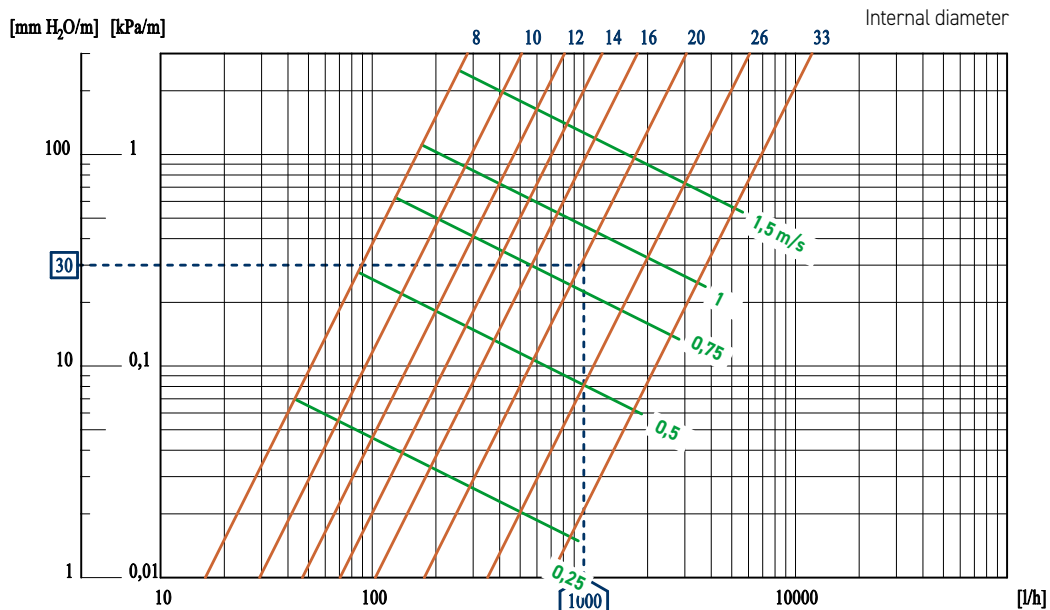

$$\Delta p_t = (40 \times 30) + 25\% = 1500 \text{ mm H}_2\text{O}$$

The total headloss up to here calculated brings to the following value:

$$\Delta p = \Delta p_s + \Delta p_c + \Delta p_t = 200 + 1600 + 1500 = 3300 \text{ mm H}_2\text{O}$$

At this point it is necessary to consider the presence of the solar station, to define the appropriate model of circulating pump which has to be used. Taking into consideration a *qt* always 1000 l/h and using, for example, a S2 Solar 3 8-28 L/min (480-1680 l/h) solar station, its total headloss is $\cong 400 \text{ mm H}_2\text{O} \cong 0,4 \text{ m H}_2\text{O}$ (Draw. 4).

Altogether the headloss is $\cong 3700 \text{ mm H}_2\text{O} \cong 3,7 \text{ m H}_2\text{O}$.

Draw. 4 - Performance curves of the pumping stations and of the circulating pumps

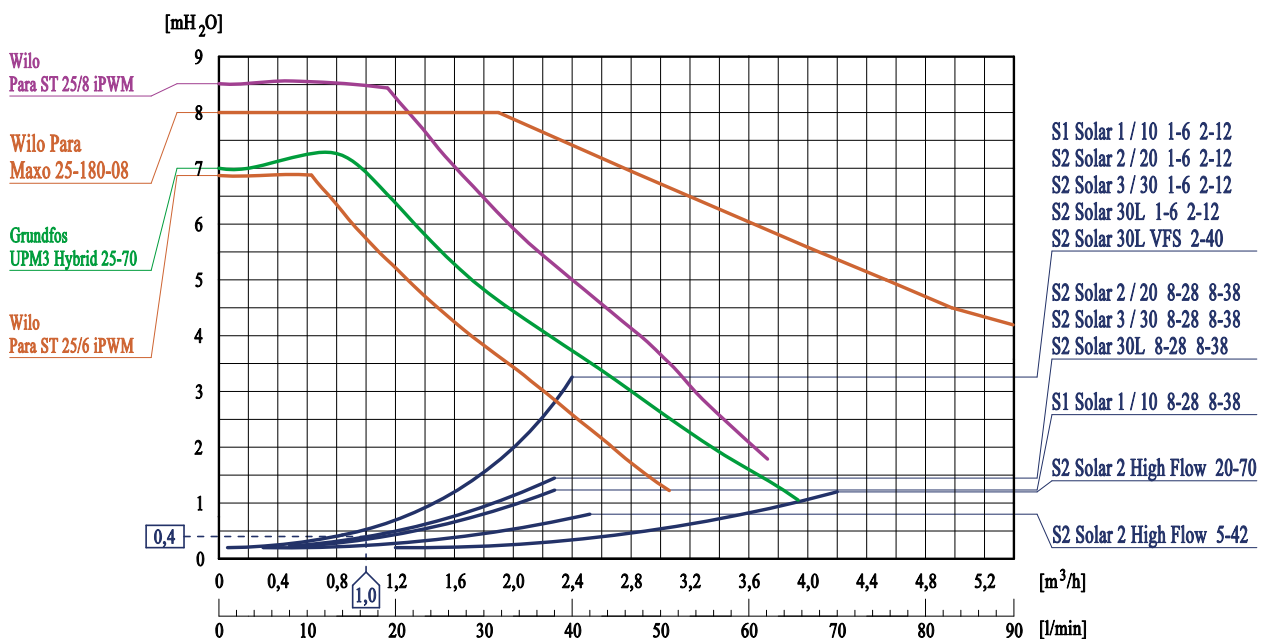

The model of circulating pump to be used is determined by the typical curve that is getting the closest to the calculated working point by excess; therefore the choice is for a circulating pump with a maximum nominal head of 6 m. So there is a margin to adjust its performance to the features of the installation. Operating the speed switch of the circulating pump (e.g. from III to II) or the flow regulator, it is possible to take the working back to the flow value previously determined: 1000 kg/h \cong 16 l/min.

The reliability of a solar thermal system depends on the quality and on the life of the components and of the used materials.

Of course you must be sure that all the materials conform with the plan and with the prescriptions of the manufacturer. Of course you must be sure that all the materials conform with the plan and with the prescriptions of the manufacturer. It is also better to verify the accuracy of the course of the pipes as concerns the balance of the installation; on this purpose a test of the compensation of the circuit must be done.

Then it is necessary to pay attention to the regulation of the plant, by checking that the collector sensor is correctly connected, the buffer tank sensor is sufficiently dipped, the controller has been installed following the instructions. The working tests usually foresee a circulation test of the fluid and a wet seal test. The late regulations concerning the energy saving and the obligatoriness of the use of the alternative energy establish the check of the installation even in the case of a solar plant.

The thermic check of a solar system is made to verify the efficiency and the quantity of energy transferable to the users. The data to be taken into consideration for this check are the following:

- The inlet and the outlet fluid temperature of the solar collectors;
- The inlet and the outlet fluid temperature of the heat exchanger, filling side (domestic and heating);
- The fluid flow in the solar circuit and in the filling circuit.

The average efficiency of the solar installation η_m can be calculated as follows:

$$\eta_m = \frac{Qu}{H \times Ac}$$

where $Qu = qm \times c \times \Delta t$ is the power expressed in [kW]; H is the solar energy incident on the solar collector during the determined time [kJ/m² · period]; Ac is the area of the tapping surface.

Some remarks on the High Flow and Low Flow systems

According to the working conditions the solar installations can be fundamentally classified in two kinds: **high flow** and **low flow**; the element that decides the belongings to one or another category is the specific flow that is circulating into the solar collectors. In the first case it is about 0.5÷0.85 l/(min×m²), while in the second case it is about 0.25÷0.35 l/(min×m²).

To do a general sizing like the one of the previous example, it is necessary to take into consideration that, starting from the available tapping surface (therefore from the real power supplied by the collectors) the choice of one or another technology brings to get a big ΔT difference in the exchanger: the **high flow** installations are working with a maximum 10 K meanwhile in the **low flow** installations the ΔT is up to 25 K.

Starting from the above considerations and taking as exemplifying values of specific flow respectively 0.7 l/(min×m²) and 0.3 l/(min×m²) for the two system technologies, the table at side shows the maximum transferable powers according to the different "sizes" of the installation.

The sizing described in the previous pages is pertinent to a **high flow** installation. If, on the contrary, it had opted for a **low flow** system, it would have been necessary to reconsider also all the section of the calculation concerning the estimation of the headlosses and the consequent selection of the circulating pump.

The **high flow** systems are mainly used, meanwhile **low flow** technology, thanks to the high Δt peculiar of this system, it is possible to get good results in case they want to push significantly the stratification of the water tank.

Maximum transferable heating power*

Flow of the solar installation	Low Flow system Q = 0,3 l/min×m ² $\Delta T = 25 K$	High Flow system Q = 0,7 l/min×m ² $\Delta T = 10 K$
1-6 l/min	20 kW	8,5kW
2-12 l/min	40 kW	17 kW
8-28 l/min	93 kW	40 kW
8-38 l/min	127 kW	54 kW
5-42 l/min	140 kW	60 kW
20-70 l/min	233 kW	99 kW



* **Warning:** during the sizing, please check that the heat exchanger is compatible with the requested power and/or subdivide the buffer tanks.

Art 776

SOLAR ANTI-SCALD THERMOSTATIC MIXING VALVE

Anti-scald thermostatic mixing valve with 1" Male connection for solar applications. DZR brass body. Adjustable user temperature from 30°C up to 65°C by means of a knob.

- Max static pressure 10 bar (PN 10); dynamic 5 bar.
- Max ratio between pressures 2:1.
- Max inlet temperature: constant 100°C; (short time: 120°C for 20 s).
- Setting range: 30÷65°C. Accuracy ± 2°C.

External connections: 3/4" or 1" Male flat seal.



Available Kvs:

1,5 (3/4" code 03776-1.5-S) Up to 31 l/min (1,5 bar)
1,7 (1" code 04776-1.7-S) Up to 35 l/min (1,5 bar)
2,4 (1" code 04776-2.4-S) Up to 49 l/min (1,5 bar)



Available temperatures:

Adjustable temperature
from **30°C to 65°C**



Layout: symmetric

Code 3/4": **03776-1.5-S**
Code 1": **04776-1.7-S**
Code 1": **04776-2.4-S**



PED 2014/68/EU 4.3



The safety anti-scald device automatically stops the hot water flow in case of failure of the cold water line.

Art 776 C

SOLAR ANTI-SCALD THERMOSTATIC MIXING VALVE FOR OEM

Anti-scald thermostatic mixing valve with male connection for solar applications. DZR brass body. Adjustable user temperature from 30°C up to 65°C by means of a cartridge.

- Max static pressure 10 bar (PN 10); dynamic 5 bar.
- Max ratio between pressures 2:1.
- Max inlet temperature: constant 100°C; (short time: 120°C for 20 s).
- Setting range: 30÷65°C. Accuracy ± 2°C.
- Supplied calibrated at the temperature of 48°C and stopped by special nut.
- Protection cap.
- Supplied on blister pack (multiple packaging).

External connections: 3/4" or 1" Male flat seal.



Available Kvs:

1,5 (3/4" code 03776C-OEM-1.5-S) Up to 31 l/min (1,5 bar)
1,7 (1" code 04776C-OEM-1.7-S) Up to 35 l/min (1,5 bar)

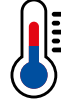

Available temperatures:

Adjustable temperature
from **30°C to 65°C**



Layout: symmetric

Code 3/4": **03776C-OEM-1.5-S**
Code 1": **04776C-OEM-1.7-S**



PED 2014/68/EU 4.3

Available with 3/4" Male union connections: Art. 779

Anti-scald thermostatic mixing valve for solar applications with 3/4" Male union connections. High temperature check valves and filters, built into fittings, at both inlets of hot and cold water. DZR brass body and connections.
Same features as art. 776.

Code 1/2": **02779-1.5-S**
Code 3/4": **03779-1.7-S**
Code 3/4": **03779-2.4-S**



Available Kvs:

1,5 (1/2" code 02779-1.5-S) Up to 31 l/min (1,5 bar)
1,7 (3/4" code 03779-1.7-S) Up to 35 l/min (1,5 bar)
2,4 (3/4" code 03779-2.4-S) Up to 49 l/min (1,5 bar)

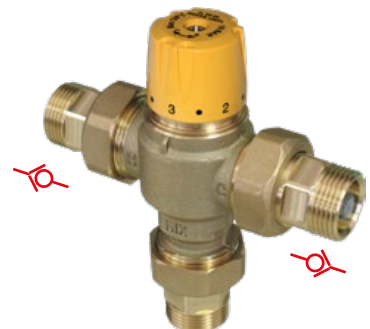

PED 2014/68/EU 4.3



In compliance to the Italian Ministerial Decree N°174/2004.

Following specific laboratory tests, the mixing valve, art 726, has been verified to comply with D.M. 174/2004. The other articles of the same family of thermostatic mixing valves are similar to the verified model, having the same components and equal contact surface.

THERMOSTATIC MIXING AND DIVERTING VALVES

DIVERTING VALVE 48°C

Art 786

SOLAR THERMOSTATIC DIVERTING VALVE

Thermostatic diverting valve with 1" Male connection for solar applications with pre-setting temperature at 48°C. DZR brass body. The valve proportionally and automatically diverts water between outlets 1 and 2 marked on the body, depending upon inlet temperature: temperatures less than 48°C are diverted to outlet 1, higher temperatures to outlet 2.

- Max static pressure 10 bar (PN 10); dynamic 5 bar.
- Max ratio between pressures 2:1.
- Max inlet temperature: constant 100°C (short time: 120°C for 20 s).
- Fixed calibration: 48°C ± 2°C (not adjustable).

External connections: 1" Male flat seal.



Available Kvs:

- 1,7 (1" code **04786-1.7-S**) Up to 35 l/min (1,5 bar)
- 2,4 (1" code **04786-2.4-S**) Up to 49 l/min (1,5 bar)

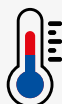

Diverting temperature:

Temperature **48°C** (not adjustable)



Layout: symmetric

Code 1": **04786-1.7-S**

Code 1": **04786-2.4-S**

PED 2014/68/EU 4.3

Available with 3/4" Male union connections: Art. 789

Thermostatic diverting valve for solar applications with 3/4" Male union connections. High temperature check valve and filter, built into hot water inlet fitting coming from solar circuit. DZR brass body and connections.

Same features as art. 786.



Available Kvs:

- 1,7 (3/4" code **03789-1.7-S**) Up to 35 l/min (1,5 bar)
- 2,4 (3/4" code **03789-2.4-S**) Up to 49 l/min (1,5 bar)

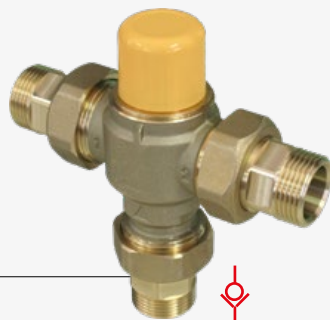

Code 3/4": **03789-1.7-S**

Code 3/4": **03789-2.4-S**

PED 2014/68/EU 4.3

Serie 780R

HIGH PERFORMANCE ADJUSTABLE THERMOSTATIC DIVERTING VALVES

Thermostatic diverting valves with adjustable diverting temperature from 38°C up to 54°C by means of a graduated knob. Kvs 3.5. Available external connections: 3/4" Male pipe unions and 1" male flat seal.

See the section "Thermostatic Diverting Valves".



Layout: asimmetrico



Check valve union connection set

The set consists of: nut, high temperature resistant gasket and solar male union.

- Built-in 20 mbar check valve specific for solar applications.
- Built-in filter.
- Max temperature: 120°C.

Available sizes: 1/2" x 3/4" Nut or 3/4" x 1" Nut.



Code 1/2" x 3/4" Nut: **DBO102S/SET**

Code 3/4" x 1" Nut: **DBO103S/SET**



Warning: as the check valve is inside the union, it can be fitted only to the inlet connections indicated below: Mixing valves Art. 776 and 776C: hot water inlet (H) and cold water inlet (C). Diverting valves Art. 786: water inlet, marked with an arrow.

Union connection set

The set consists of: nut, high temperature resistant gasket and solar male union.

Available sizes: 1/2" x 3/4" Nut or 3/4" x 1" Nut.



Code 1/2" x 3/4" Nut: **DBO102/SET**

Code 3/4" x 1" Nut: **DBO103/SET**



In compliance to the Italian Ministerial Decree N°174/2004.

Following specific laboratory tests, the mixing valve, art 726, has been verified to comply with D.M. 174/2004. The other articles of the same family of thermostatic mixing valves are similar to the verified model, having the same components and equal contact surface.

Solar thermostatic mixing valves

The thermostatic mixing valve is used in solar thermal systems for delivering domestic hot water and it controls temperature to preset value. It allows to keep constant mixed water temperature for the end user, regardless of inlet conditions both of hot and cold water.

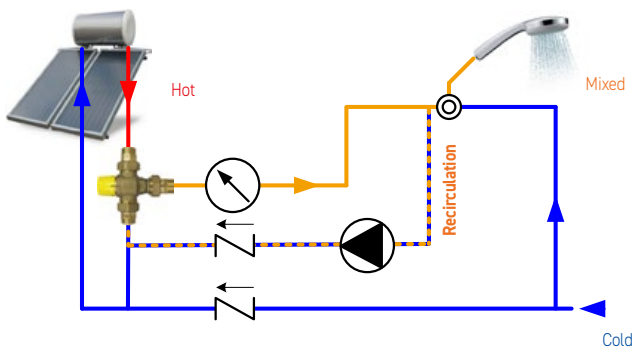

The hydraulic scheme is to be considered just an indication

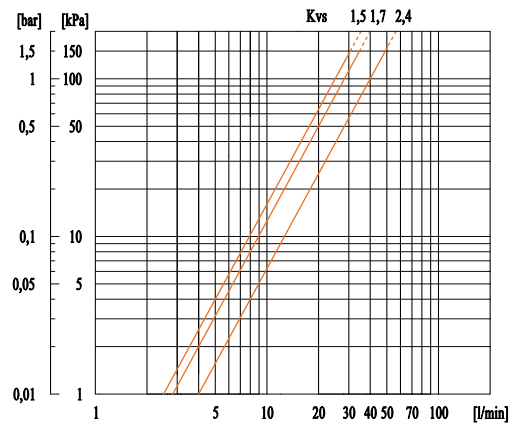

Knob: reference temperatures

MIN	1	2	3	4	5	MAX
~25°C	30°C	40°C	49°C	57°C	65°C	~70°C

$T_H = 65^\circ\text{C}$

$T_c = 15^\circ\text{C}$

$P = 3 \text{ bar}$

Max recommended flow rate for a constant flow within $\pm 2^\circ\text{C}$.

Kvs	Max l/min
1,5	31
1,7	35
2,4	49

Not applicable for art. 776C

Solar thermostatic diverting valves

The function of the valve is to divert hot water, coming from the solar buffer tank, into the boiler buffer tank, when the temperature of the solar buffer tank is less than 48°C (factory fixed calibration). On the contrary if, as it happens during the summer, the temperature is over 48°C , hot water is directly sent to the thermostatic mixing valve. Thanks to the diverting valve the working time of the boiler is reduced to the minimum, avoiding intermittent startings.

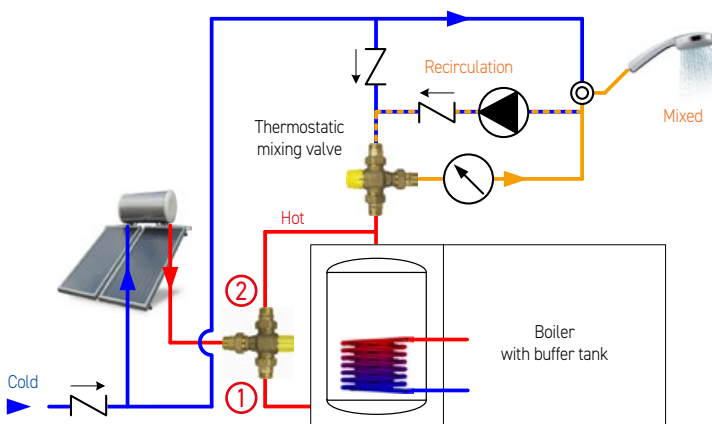

The hydraulic scheme is to be considered just an indication

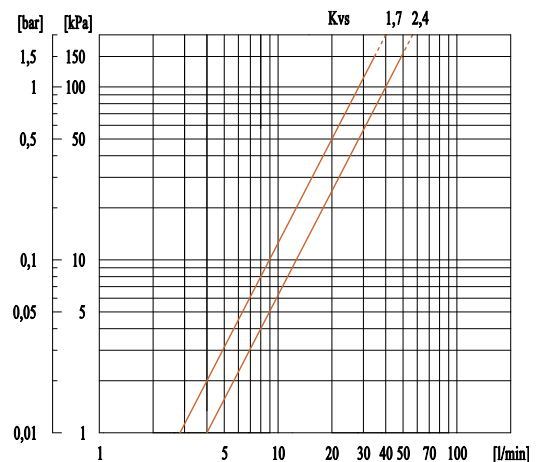

DANGER OF SCALDS - Adjustment temperatures of the mixed water at the user more than 55°C can cause scalds in short time, particularly to kids. In this case we recommend to install a safety anti-scald device before the outlets considered dangerous (showers, etc.).

SOLAR - BOILER KIT

FIX TEMPERATURE DIVERTING VALVE: 48°C

Solar Kit 1

SOLAR-BOILER THERMOSTATIC CONNECTION KIT

The kit, fully assembled and tested, consists of:

Inlet

- Thermostatic diverting valve 1" Male with fixed setting temperature at 48°C. Body made of DZR brass.
- Solar check valve and filter built in the connection pipe to the solar buffer tank.
- T-shaped swivel connection to the boiler with buffer tank.

Outlet

- Anti-scald thermostatic mixing valve 1" Male. Body made of DZR brass. Control of the user temperature adjustable by means of a knob from 30°C up to 65°C.
- Solar check valve and filter built in the connection pipe to the cold water.

Centre Distance 136 mm.

EPP insulation box (Dimensions: 234x128x100 mm).

T-shaped central connection with adjustable angular position of the connections. In some positions it'll be necessary to remove the insulation box.

- **Maximum static pressure 10 bar (PN 10); dynamic 5 bar.**
- **Maximum ratio between pressures 2:1.**
- **Inlet maximum temperature: constant temperature 100°C; (short time temperature: 120°C for 20 s).**
- **Temperature adjustment field: 30÷65°C. Accuracy ± 2°C.**

External connections: 3/4" Male (swivel connection).



Code 3/4" Kvs 1,2: **103685-1.2**
Code 3/4" Kvs 1,7: **103685-1.7**



Available Kvs:

- 1.2** = Small water consumption; max. 35 L/min (3 bar)
- 1.7** = Middle water consumption; max. 49 L/min (3 bar)

PED 2014/68/EU 4.3



Scheme of a solar thermal system, gravity or forced circulation

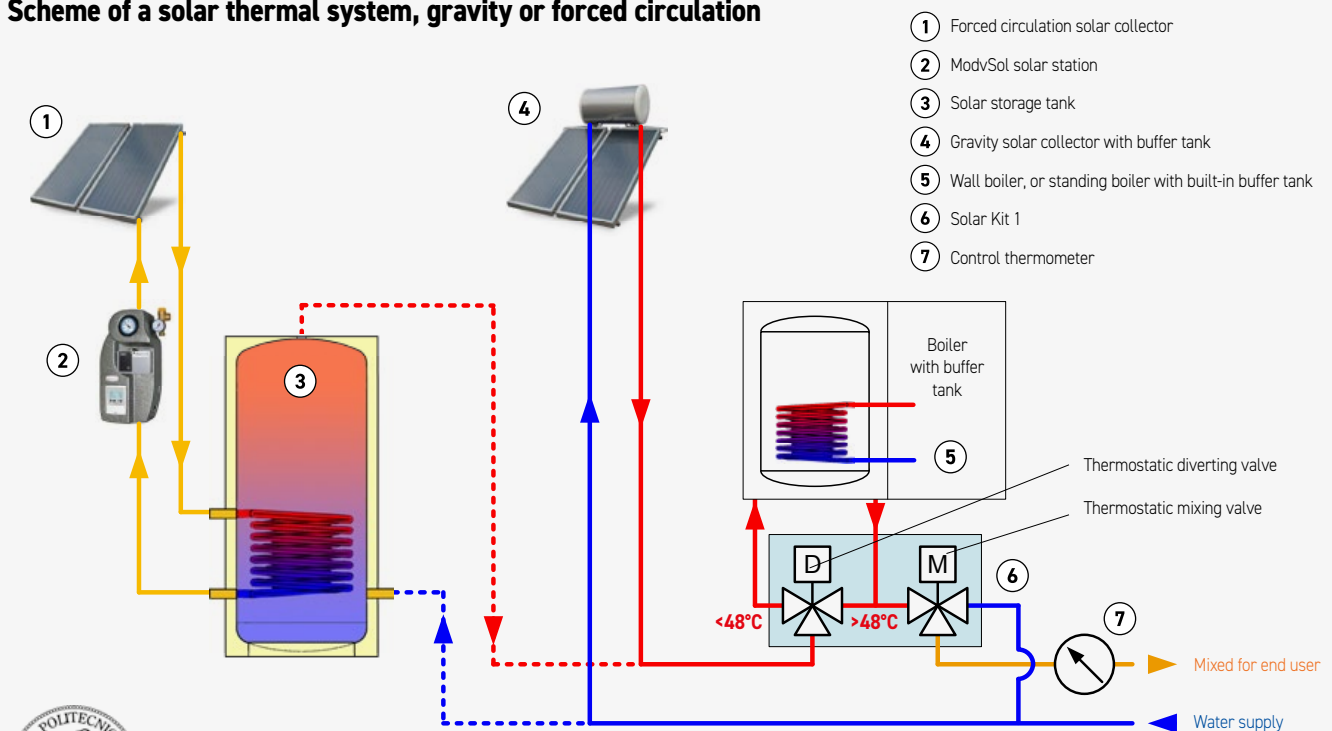

- ① Forced circulation solar collector
- ② ModvSol solar station
- ③ Solar storage tank
- ④ Gravity solar collector with buffer tank
- ⑤ Wall boiler, or standing boiler with built-in buffer tank
- ⑥ Solar Kit 1
- ⑦ Control thermometer



In compliance to the Italian Ministerial Decree N°174/2004.

Operation principle

The solar kit for boiler allows to manage automatically and to exploit at its best the thermal energy delivered by a solar thermal system during any time of the year and to supply domestic hot water for end user, at a controlled temperature.

The kit, supplied in a suitable and smart EPP insulating box, works in two ways:

In case the temperature of water coming from solar buffer tank, either a gravity or a forced loop with glycol, is high enough, for example in summer, the first device of the kit, a diverting valve, diverts fluids towards the mixing valve (scheme 1). Then the mixing valve mixes the fluid with cold water from mains, up to presetted temperature.

On the contrary, as it happens in winter, if the temperature of water in solar water tank is low (less than 48°C; note: diverting valve is factory calibrated to divert from 48°C), diverting valve proportionally diverts pre-heated fluid towards the boiler buffer tank. In this case solar energy is fully exploited and intervention time for boiler to increase temperature is reduced to minimal, (scheme 2). The anti-scald mixing valve checks and regulates the temperature of the water to the end user.

The anti-scald function automatically stops the hot water flow in case of failure in the cold water line.

Most popular solar hydraulic schemes

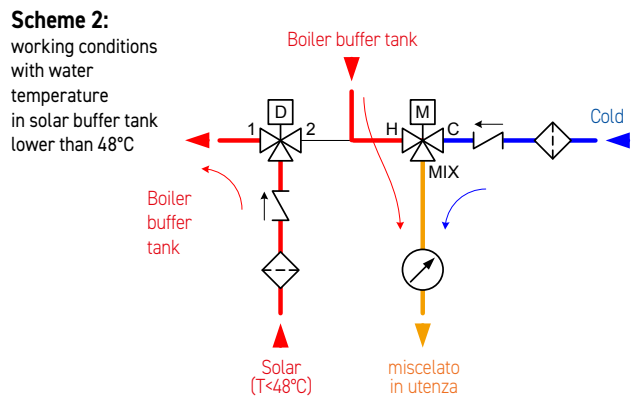
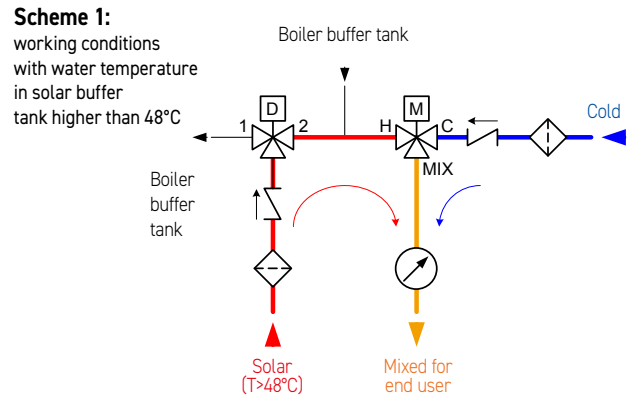
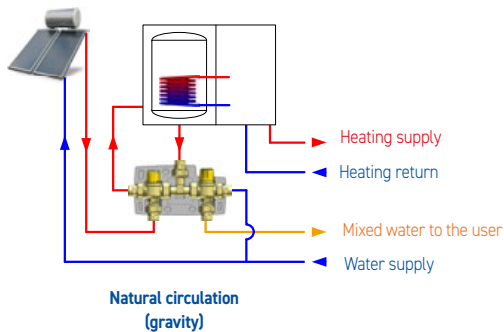
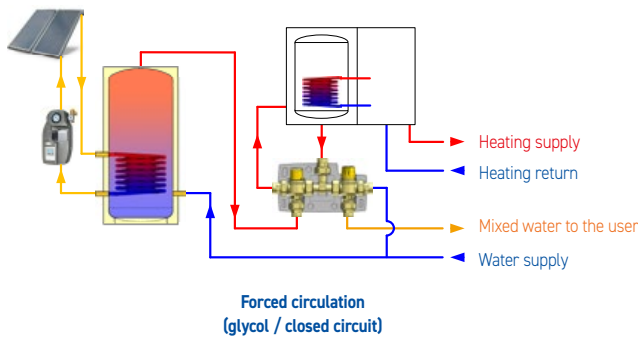

- Diverting valve with fixed calibration;** exit towards **port 1** with temperature < 48°C; towards **port 2** with temperature > 48°C.
- Anti scald thermostatic mixing valve, adjustable from 30°C to 65°C;** **H** inlet hot water from the brass fitting; **C** inlet cold water from mains; **MIX** exit mixed hot water towards end user.
- Solar check valve**
it is built into the 3/4" male fitting
- Filter**
it is built into the 3/4" male fitting

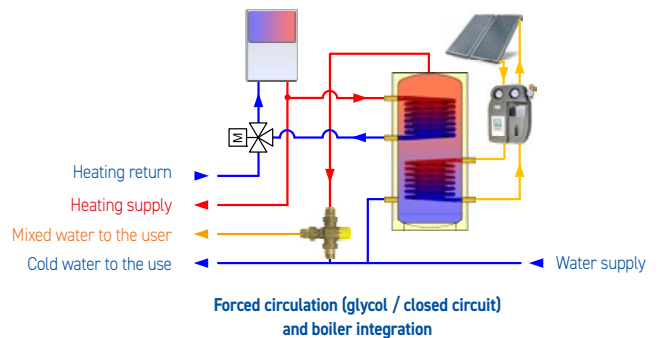

! DANGER OF SCALDS - Adjustment temperatures of the mixed water at the user more than 55°C can cause scalds in short time, particularly to kids. In this case we recommend to install a safety anti-scald device before the outlets considered dangerous (showers, etc.).

SOLAR THERMAL

SOLAR - BOILER KIT ADJUSTABLE DIVERTING VALVE 38÷54°C

Solar Kit 2

SOLAR-BOILER THERMOSTATIC CONNECTION KIT WITH ADJUSTABLE DIVERTING TEMPERATURE

The kit, fully assembled and tested, consists of:

Inlet

- Thermostatic diverting valve 1" Male with adjustable diverting temperature from 38°C up to 54°C, by means of a graduated knob - Kvs 3.5.
- Solar check valve and filter built in the connection pipe to the solar buffer tank.
- T-shaped swivel connection to the boiler with buffer tank.

Outlet

- Anti scald thermostatic mixing valve 1" Male - Kvs 2.5. Control of the user temperature adjustable by means of a knob from 35°C up to 60°C.
- Solar check valve and filter built in the connection pipe to the cold water.

Centre distance 163 mm (95 mm boiler).

EPP insulation box (Dimensions: 255x125x100 mm).

T-shaped central connection with adjustable angular position of the connections. In some positions it'll be necessary to remove the insulation box.

- **Maximum static pressure 10 bar (PN 10); dynamic 5 bar.**
- **Maximum ratio between pressures 2:1.**
- **Inlet maximum temperature: constant temperature 100°C; (short time temperature: 120°C for 20 s).**
- **Diverting valve temperature setting range: 38°÷54°.**
- **Commutating field 4K (between 42 and 52°C)**
- **Users temperature setting range: 35°÷60°C.**
- **Accuracy ±1°C.**

External connections: 3/4" Male (swivel connection).



Code 3/4" Kvs 1.7: **103736-1.7**



Available Kvs:

1.7 = Middle water consumption; max. 49 L/min (3 bar)



Diverting temperature:

Adjustable from **38°C** up to **54°C**

PED 2014/68/EU 4.3



Scheme of a solar thermal system, gravity or forced circulation

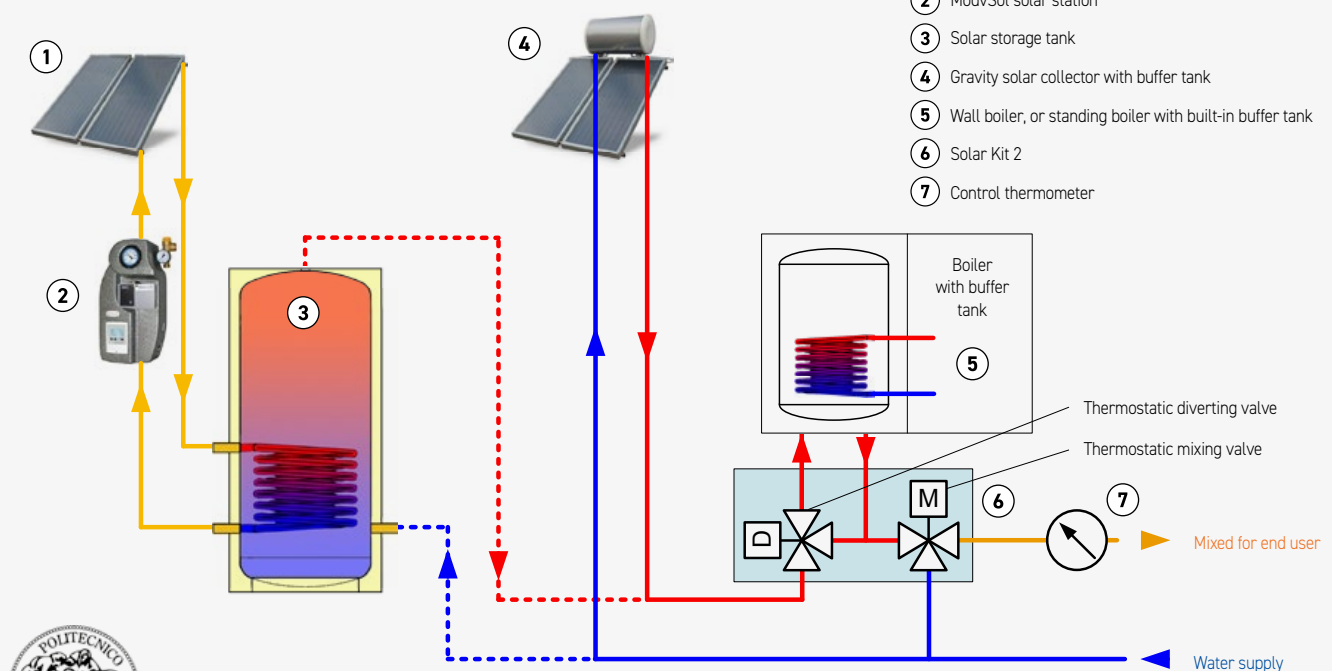

- ① Forced circulation solar collector
- ② ModvSol solar station
- ③ Solar storage tank
- ④ Gravity solar collector with buffer tank
- ⑤ Wall boiler, or standing boiler with built-in buffer tank
- ⑥ Solar Kit 2
- ⑦ Control thermometer



In compliance to the Italian Ministerial Decree N°174/2004

Operation principle

The adjustable solar kit for boiler allows to manage automatically and to exploit at its best the thermal energy delivered by a solar thermal system and to supply domestic hot water for the end user, at a controlled temperature. The adjustable diverting valve allows to maximize the exploitation being able to adapt the diverting temperature to the installation features, geographic location and user's habits. It is also possible to change the diverting temperature in accordance with the seasons of the year: lower temperature in summer time or higher temperature in winter time.

The kit, supplied in a suitable and smart EPP insulating box, works in two ways:

In case the temperature of water coming from solar buffer tank, either a gravity or a forced loop with glycol, is high enough, for example in summer, the first device of the kit, the adjustable thermostatic diverting valve, at the selected temperature, diverts the fluid towards the thermostatic mixing valve, so avoiding ineffective boiler startings (scheme 1). Then the mixing valve mixes the fluid with cold water from mains, up to presetted temperature.

On the contrary, as it happens in winter, if the temperature of water in solar water tank is low (lower then the selected temperature) the first valve diverts in a proportional way the pre heated fluid towards the boiler buffer tank, so exploiting to the maximum its energy and reducing to the minimum the boiler intervention time (scheme 2). The anti-scald thermostatic mixing valve, placed at the outlet of the kit, always controls and limits the water temperature to the user.

! The anti-scald function automatically stops the hot water flow in case of failure in the cold water line.

Most popular solar hydraulic schemes

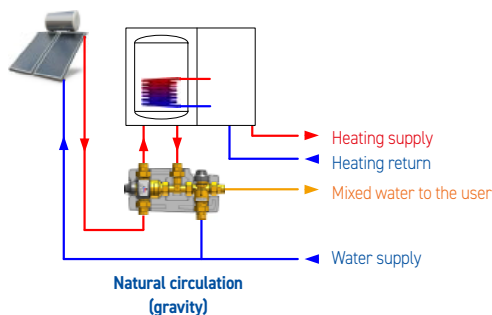
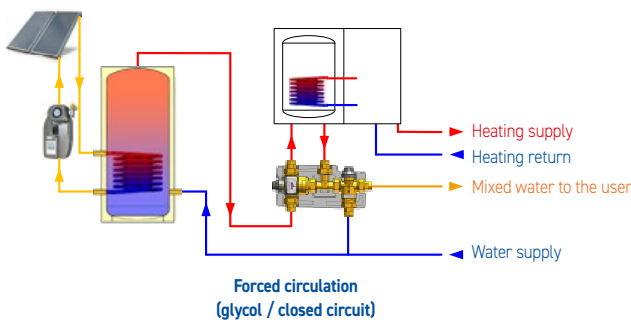

! **DANGER OF SCALDS** - Adjustment temperatures of the mixed water at the user more than 55°C can cause scalds in short time, particularly to kids. In this case we recommend to install a safety anti-scald device before the outlets considered dangerous (showers, etc.).

Scheme 1:
working conditions
at a diverting
temperature of 42°C
(summer time setting)

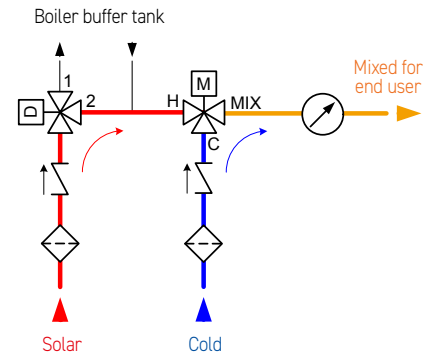

Scheme 2:
working conditions
at a diverting
temperature of 48°C
(winter time setting)

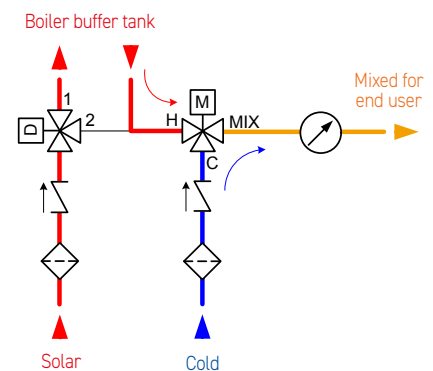

Adjustable thermostatic diverting valve: outlet towards the **port 1** if the temperature is lower than the selected temperature; outlet towards the **port 2** if it is higher than the selected value.



Anti scald thermostatic mixing valve, adjustable from 30°C to 65°C; **H** inlet hot water from the brass fitting; **C** inlet cold water from mains; **MIX** exit mixed hot water towards end user.



Solar check valve
it is built into the 3/4" male fitting



Filter
it is built into the 3/4" male fitting

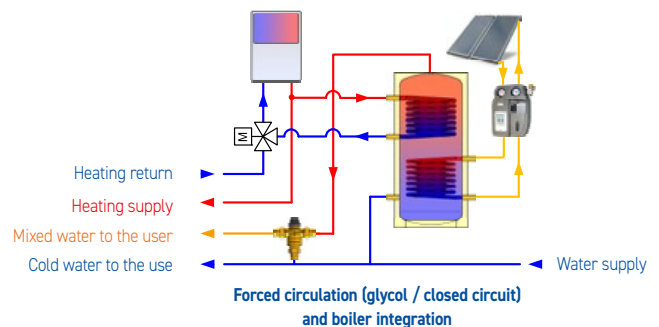

S2 HEAT EXCHANGE SOLAR UNIT HEAT EXCHANGE

S2 Exchange HEAT EXCHANGE SOLAR UNIT

Heat exchange unit for solar circuits with insulation box, made of hot forged brass. By means of this unit it is possible to connect a solar plant without using a dedicated storage tank (double coil) or to connect it directly to the buffer tank. Asymmetric weld-braided plate heat exchanger made of stainless steel AISI 316. Designed for direct connection to the 2-way 1" solar pumping stations by means of a swivel nut. It is also possible to connect several fittings to the "T" connectors; a $\varnothing 6$ mm sensor holder pit is provided on the supply way of the solar circuit (primary).

Centre distance 125 mm.

EPP insulation box (Dimensions: 250x143x218 mm).

PN 10. Constant temperature 120°C (short time temperature: 160°C for 20 s).

External connections: 1" nut (solar primary circuit) x 1" Male (buffer tank secondary circuit).

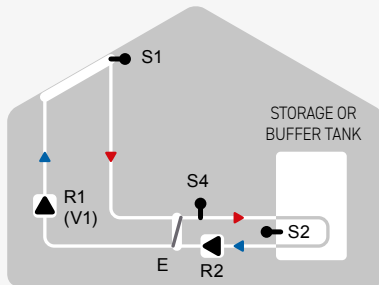

Standard scheme

- **S1:** Collector temperature sensor.
- **S2:** Water storage temperature sensor.
- **S4:** Temperature sensor on supply way to storage.
- **R1(V1):** Solar high efficiency circulating pump (primary). The flow is adjusted and set by the flowmeter.
- **R2:** Variable speed high efficiency circulating pump for the buffer tank (secondary).
- **E:** Plate heat exchanger.



Code: see below table

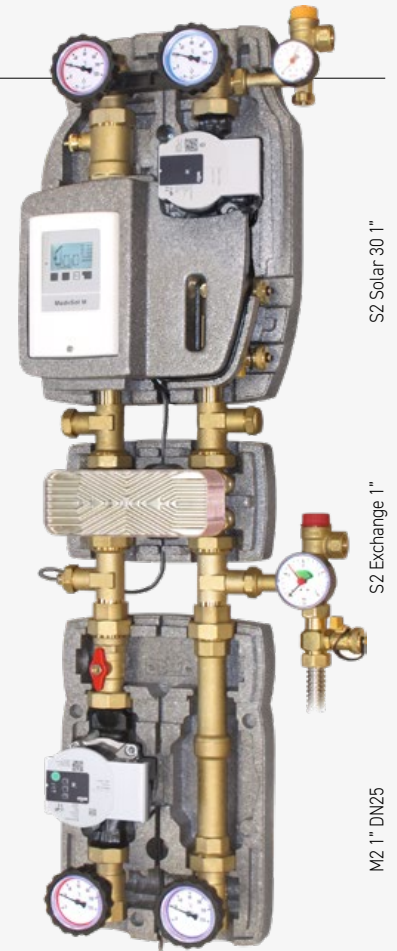

Standard installation controlled by the ModvSol M solar controller.

Field of use

For power up to:	3,5 kW	5 kW	10 kW	20 kW
Collector surface (max.):	7,5 m ²	10 m ²	20 m ²	40 m ²
Solar circuit flow rate (max.): "High Flow" technology	5 l/min	7 l/min	15 l/min	28 l/min
Solar side head loss (primary) * :	0,1 mH ₂ O	0,2 mH ₂ O	0,3 mH ₂ O	0,5 mH ₂ O
Secondary side flow rate:	400 l/h	690 l/h	1.460 l/h	2.720 l/h
Secondary side head loss * :	0,4 mH ₂ O	1,2 mH ₂ O	1,6 mH ₂ O	2,3 mH ₂ O
Code:	304646-5KW	304646-5KW	304646-10KW	304646-20KW

* : Head loss of the heat exchanger alone at the maximum flow rate, with reference to the corresponding loop.

Note: These data must be considered just as an indication. They are based on the considerations made of the section "The design of a solar thermal system" of the Modvlvs catalogue, in conformity with the "High Flow" technology and on the average performances of the circulating pumps. The data must be checked taking into consideration the specifications of the installation that is to be carried out.

Safety unit

Safety unit for the solar tank circuit (secondary) provided with CE and TÜV certified 3 bar safety valve and a $\varnothing 50$ mm 0-4 bar pressure gauge. 3/4" Male connection for the flexible pipe or the draining set (103647P). End of drain side: 3/4" F. The connection to the "T" connector is allowed by means of a special seal kit with precharged EPDM OR that does not need any seal paste, hemp or other sealants.

50 kW safety valve.
PN 10. Max Temperature 110°C.

Code: **03647D-3C-4SET**

CE



Filling/draining valve

Ball valve suitable for solar or heating use made of brass, to fill/drain the installation. The connection to the "T" connector is allowed by means of a special seal kit with precharged EPDM O-Ring that does not need any sel paste, hemp or other sealants.

End of drain side 3/4" Male.
PN 10. Constant temperature 120°C (short time temperature: 160°C for 20 s).

Code: **01646R-430SCASET**



Draining set for safety unit

Hot forged brass connection with ball valve to fill/drain the installation.
3/4" Nut for the connection to the safety unit.
3/4" Male for the connection to the expansion vessel.

End of drain side 3/4" Male.
PN 10. Constant temperature 120°C (short time temperature: 160°C for 20 s).

Code: **103647P**



Sensor holder pit

Sensor holder pit $\varnothing 6$ mm for TT series sensors.
Equipped with a M4 screw to fix the temperature sensor.
The connection to the "T" connector is allowed by means of a special seal kit with precharged EPDM O-Ring that does not need any seal paste, hemp or other sealants.

PN 10. Constant temperature 120°C; (short time temperature: 160°C for 20 s).

Code: **POZ-646-6SET**



Solo 1
PUMP UNIT TO LOAD A BUFFER TANK

Compact fully assembled pump unit to supply the heat produced by a solar thermal system with High Flow or Low Flow operating mode. Suitable to be used with 1 buffer tank. It is supplied fully insulated and pre-wired, with pre-programmed controller and it allows a fast and easy mounting. The unit consists of:

Primary solar circuit

- Flowmeter with flow regulation with filling and draining valves. Alternatively a digital flowmeter is also available.
- Synchronous solar high efficiency circulating pump.
- 3-way return ball valve with 10 mbar check valve supplied with in-handle thermometer.
- Safety unit 6 bar with ø50 mm 0-10 bar pressure gauge with 3/4" male connection to the expansion vessel. End of drain side: 3/4" F.
- Supply ball valve with 10 mbar check valve supplied with in-handle thermometer.
- Deaerator made of brass with automatic air-vent valve and isolating valve.

Heat exchanger

- Weld-braised plate heat exchanger made of stainless steel AISI 316 suitable for several powers.

Secondary circuit

- TÜV safety valve 3 bar, 50 kW. End of drain side: 3/4" F
- High efficiency synchronous circulating pump.

EPP insulation box (Dimensions: 576x585x190 mm).

A special back plate fixes the unit to the insulation box and allows a quick fitting to the wall.

PN 10. Constant temperature on the solar circuit 120°C; (short time: 160°C for 20 s). **Maximum temperature on the secondary circuit 110°C.**

Available external connections

- 1" Male for solar circuit.
- 3/4" Male pipe union for the secondary circuit.

FIELD OF USE

For power up to 35 kW. One buffer tank.
Kvs value: see the diagram below.

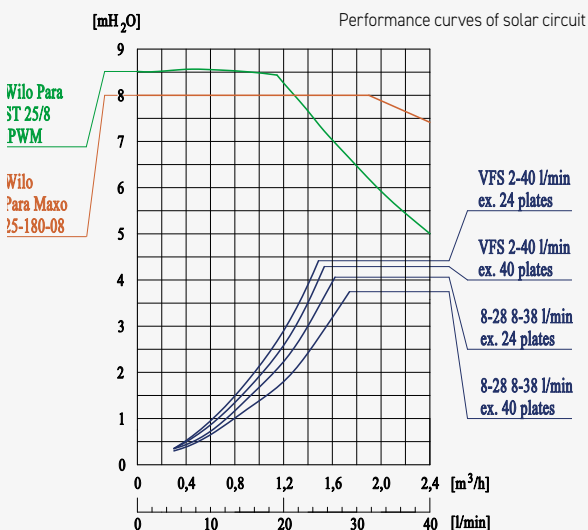

Codes: see next page.

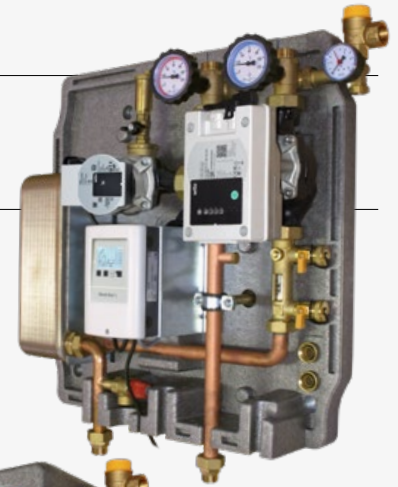

Pump unit assembled with optional ball valve kit

Ball valve kit

A special ball valve kit, available upon request (to be ordered) completes the unit.
Code: **031200SET**

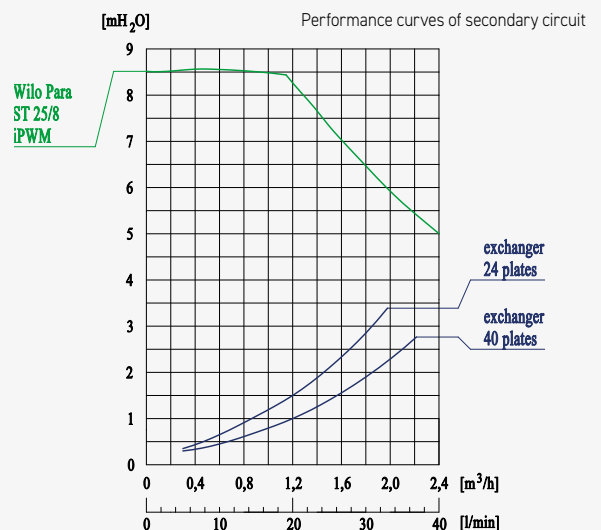

SOLO UP TO 70 m² HEAT SUPPLY

Heat supply pump unit to load a buffer tank. Suitable for a solar collector surface up to 70 m².

The pump unit, as shown in the side scheme at side, gets the heat from the primary circuit (solar) and delivers it to the heat exchanger. Then the thermal energy is transferred to the secondary circuit, and in the specific case of **ModvSol Solo 1**, the loading of the buffer tank is done in only one point, because the pump unit cannot manage the control of the stratification.

To do the loading in stratification, use the pump unit **ModvSol Solo 2**.

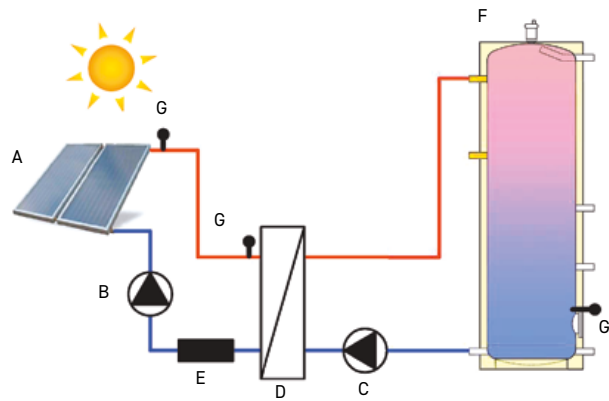

- A - Solar collectors
- B - Circulating pump of primary circuit
- C - Circulating pump of secondary circuit
- D - Heat exchanger
- E - Mechanical flowmeter or digital VFS sensor
- F - Buffer tank
- G - Temperature sensors

Note: the schemes are incomplete and to be considered just as an indication.

Solo 1 High Flow

Article code	Absorbing surface of solar collectors	Delivered thermal power	Δt	Primary circuit circulating pump	Secondary circuit circulating pump
031200-24-(28/40)-LT	30 m ²	15 kW	10 K	Wilo Para ST 25/8 iPWM	Wilo Para ST 25/8 iPWM
031200-40-(38/40)-LT	46 m ²	23 kW	10 K	Wilo Para Maxo 25-180-08	Wilo Para ST 25/8 iPWM

Solo 1 Low Flow

Article code	Absorbing surface of solar collectors	Delivered thermal power	Δt	Primary circuit circulating pump	Secondary circuit circulating pump
031200-24-(28/40)-LT	50 m ²	25 kW	25 K	Wilo Para ST 25/8 iPWM	Wilo Para ST 25/8 iPWM
031200-40-(38/40)-LT	70 m ²	35 kW	25 K	Wilo Para Maxo 25-180-08	Wilo Para ST 25/8 iPWM

It is possible to select two versions for each model indicated in the above table: one with mechanical flowmeter, another with digital VFS sensor.

- **Models with mechanical flowmeter:** the flowmeter has a measuring range of 8-28 or 8-38 l/m, default value according to the specific model selected. Product codes of these models show options 28 or 38 respectively. For example: Solo 1, High Flow, with an exchanged power of 23 kW: **code 031200-40-38-LT**.
- **Models with digital VFS sensor:** all these models have the VFS sensor with a measuring range of 2-40 L/min. Product code of these models show the option 40.
- For example: Solo 1, High Flow, with an exchanged power of 23 kW: **code 031200-40-40-LT**.

Solo 1 ACS

PUMP UNIT TO LOAD A DHW STORAGE TANK

Compact fully assembled pump unit to supply the heat produced by a solar thermal system with High Flow or Low Flow operating mode. Suitable to be used with 1 DHW storage tank. It is supplied fully insulated and pre-wired, with pre-programmed controller and it allows a fast and easy mounting.

The unit consists of:

Primary solar circuit

- Flow meter with flow regulation with filling and draining valves. Alternatively a digital flowmeter is also available.
- Synchronous solar high efficiency circulating pump.
- 3-way return ball valve with 10 mbar check valve supplied with in-handle thermometer.
- Safety unit 6 bar with $\varnothing 50$ mm 0-10 bar pressure gauge with 3/4" male connection to the expansion vessel. End of drain side: 3/4" F.
- Supply ball valve with 10 mbar check valve supplied with in-handle thermometer.
- Deaerator made of brass with automatic air-vent valve and isolating valve.

Heat exchanger

- Weld-braised plate heat exchanger made of stainless steel AISI 316 suitable for several powers.

Secondary circuit (INOX AISI 316 pipes)

- TÜV safety valve 6 bar 50 kW, for drinking water. End of drain side: 3/4" F. Other pressures available on demand.
- Asynchronous circulating pump for DHW.

EPP insulation box (Dimensions: 576x585x190 mm).

A special back plate fixes the unit to the insulation box and allows a quick fitting to the wall.

PN 10. Constant temperature on the solar circuit 120°C; (short time: 160°C for 20 s). **Maximum temperature on the secondary circuit 110°C.**

Available external connections

- 1" Male for solar circuit.
- 3/4" Male pipe union for the secondary circuit.

FIELD OF USE

For power up to 35 kW. One buffer tank for DHW.

Kvs value: see the diagram below.

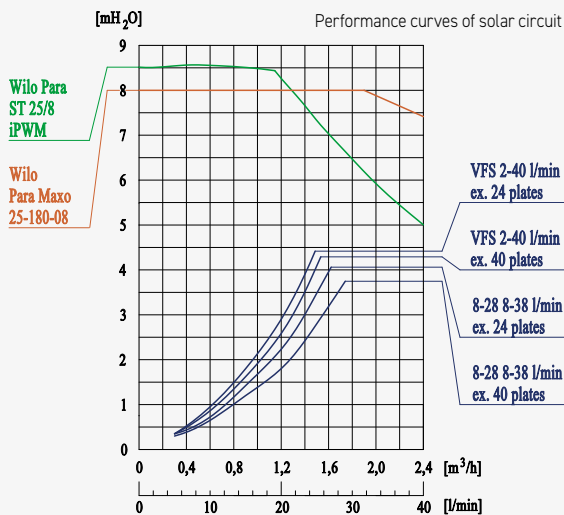

Codes: see next page.

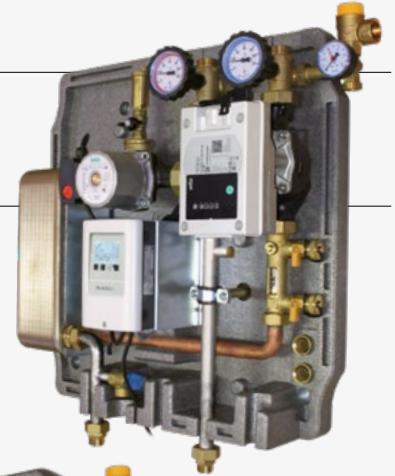

Pump unit assembled with optional ball valve kit

Ball valve kit

A special ball valve kit, available upon request (to be ordered) completes the unit.

Code: **031200SET**

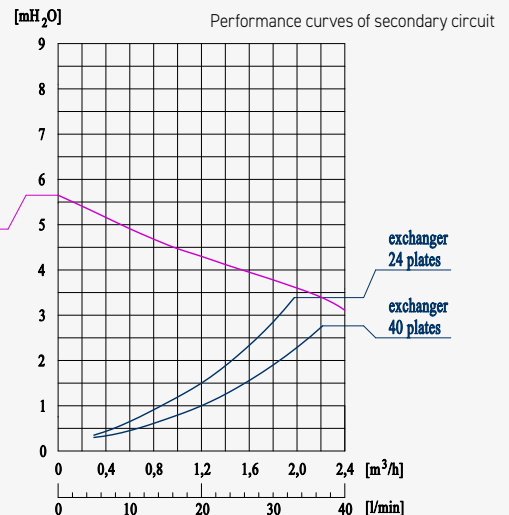

SOLO UP TO 70 m² HEAT SUPPLY

Heat supply pump unit to load a DHW storage tank. Suitable for a solar collector surface up to 70 m².

The pump unit, as shown in the side scheme, gets the heat from the primary circuit (solar) and delivers it to the heat exchanger. Then the thermal energy is transferred to the secondary circuit, and in the specific case of **ModvSol Solo 1 ACS**, it feeds directly the domestic hot water tank.

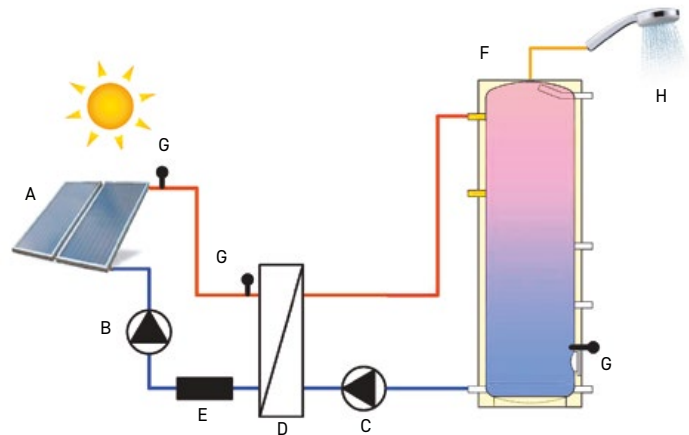

- A - Solar collectors
- B - Circ. pump of primary circuit
- C - Circ. pump of secondary circuit
- D - Heat exchanger
- E - Mechanical flowmeter or digital VFS sensor
- F - DHW tank
- G - Temperature sensors
- H - DHW for user

Note: The schemes are incomplete and to be considered just as an indication.

Solo 1 ACS High Flow

Article code	Absorbing surface of solar collectors	Delivered thermal power	Δt	Primary circuit circulating pump	Secondary circuit circulating pump
031230-24-(28/40)-LT	30 m ²	15 kW	10 K	Wilo Para ST 25/8 iPWM	Wilo Star Z 25/6
031230-40-(38/40)-LT	46 m ²	23 kW	10 K	Wilo Para Maxo 25-180-08	Wilo Star Z 25/6

Solo 1 ACS Low Flow

Article code	Absorbing surface of solar collectors	Delivered thermal power	Δt	Primary circuit circulating pump	Secondary circuit circulating pump
031230-24-(28/40)-LT	50 m ²	25 kW	25 K	Wilo Para ST 25/8 iPWM	Wilo Star Z 25/6
031230-40-(38/40)-LT	70 m ²	35 kW	25 K	Wilo Para Maxo 25-180-08	Wilo Star Z 25/6

It is possible to select two versions for each model indicated in the above table: one with mechanical flowmeter, another with digital VFS sensor.

- **Models with mechanical flowmeter:** the flowmeter has a measuring range of 8-28 or 8-38 l/m, default value according to the specific model selected. Product codes of these models show options 28 or 38 respectively. For example: Solo 1, High flow, with an exchanged power of 23 kW: **code 031230-40-38-LT**.
- **Models with digital VFS sensor:** all these models have the VFS sensor with a measuring range of 2-40 L/min. Product code of these models show the option 40.
- For example: Solo 1, High flow, with an exchanged power of 23 kW: **code 031230-40-40-LT**.

Solo 2
PUMP UNIT FOR STRATIFIED LOADING

Compact fully assembled pump unit to supply the heat produced by a solar thermal system with High Flow or Low Flow operating mode. Equipped with diverting valve operated by controller and placed on the supply way of secondary circuit. It is supplied fully insulated and pre-wired, with pre-programmed controller and it allows a fast and easy mounting. The unit consists of:

Primary solar circuit

- Flow meter with flow regulation with filling and draining valves. Alternatively a digital flowmeter is also available.
- Synchronous solar high efficiency circulating pump.
- 3-way return ball valve with 10 mbar check valve supplied with in-handle thermometer.
- Safety unit 6 bar with $\varnothing 50$ mm 0-10 bar pressure gauge with 3/4" male connection to the expansion vessel. End of drain side: 3/4" F.
- Supply ball valve with 10 mbar check valve supplied with in-handle thermometer.
- Deaerator made of brass with automatic air-vent valve and isolating valve.

Heat exchanger

- Weld-braised plate heat exchanger made of stainless steel AISI 316 suitable for several powers.

Secondary circuit

- Diverting valve.
- TÜV safety valve 3 bar, 50 kW. End of drain side: 3/4" F.
- Synchronous solar high efficiency circulating pump.

EPP insulation box (Dimensions: 576x585x190 mm).

A special back plate fixes the unit to the insulation box and allows a quick fitting to the wall.

PN 10. Constant temperature on the solar circuit 120°C; (short time: 160°C for 20 s). **Maximum temperature on the secondary circuit 110°C.**

Available external connections

- 1" Male for solar circuit.
- 3/4" Male pipe union for the secondary circuit.

FIELD OF USE

For power up to 35 kW. Stratified loading.

Kvs value: see the diagram below.

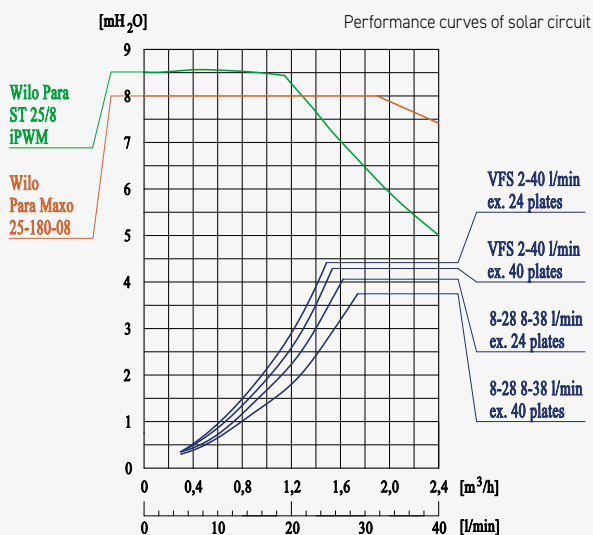

Codes: see next page.



Pump unit assembled with optional ball valve kit

Ball valve kit

A special ball valve kit, available upon request (to be ordered) completes the unit.

Code: **031250SET**

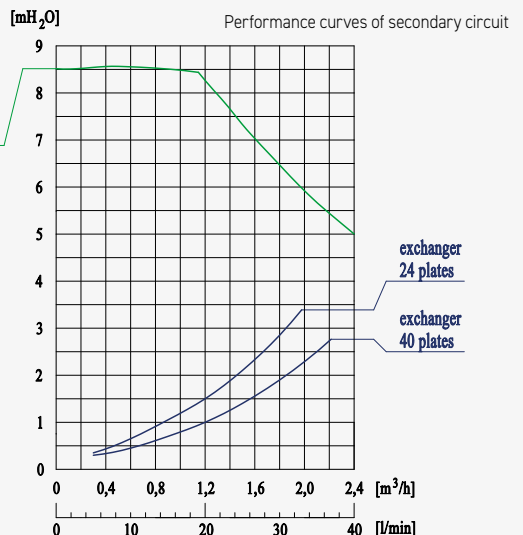

ModvSol Solo 2

Heat supply pump unit for stratified loading of a buffer tank, or for loading two buffer tank. Suitable for a solar collector surface up to 70 m².

The pump unit, as shown in the side schemes, gets the heat from the primary circuit (solar) and delivers it to the heat exchanger. Then the thermal energy is transferred to the secondary circuit in which a diverting valve is present.

It is thus possible to create multiple plant configurations: mainly the control of loading stratification of a single buffer tank, or of two buffer tanks (scheme 2); or of combined plants for heating and DHW production (scheme 3).

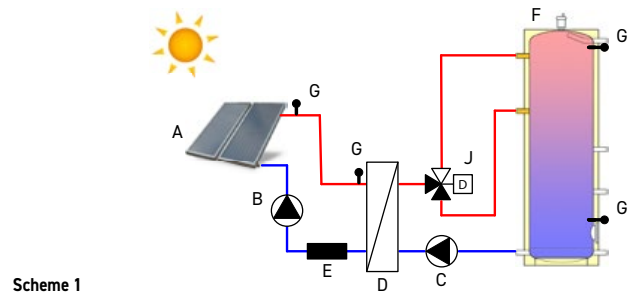

Scheme 1

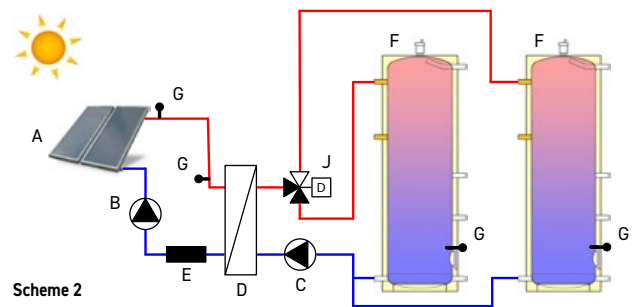

Scheme 2

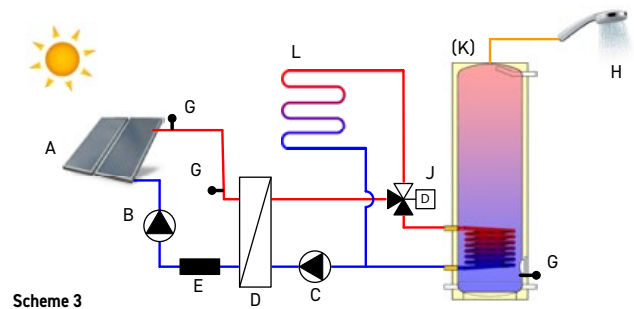

Scheme 3

- A - Solar collectors
- B - Circ. pump of primary circuit
- C - Circ. pump of secondary circuit
- D - Heat exchanger
- E - Mechanical flowmeter or digital VFS sensor
- F - Puffer
- G - Temperature sensors
- H - DHW for users
- J - Diverting valve
- K - DHW storage tank
- L - Heating circuit

Note: The schemes are incomplete and to be considered just as an indication.

Solo 2 High Flow

Article code	Absorbing surface of solar collectors	Delivered thermal power	Δt	Primary circuit circulating pump	Secondary circuit circulating pump
031250-24-(28/40)-LT	30 m ²	15 kW	10 K	Wilo Para ST 25/8 iPWM	Wilo Para ST 25/8 iPWM
031250-40-(38/40)-LT	46 m ²	23 kW	10 K	Wilo Para Maxo 25-180-08	Wilo Para ST 25/8 iPWM

Solo 2 Low Flow

Article code	Absorbing surface of solar collectors	Delivered thermal power	Δt	Primary circuit circulating pump	Secondary circuit circulating pump
031250-24-(28/40)-LT	50 m ²	25 kW	25 K	Wilo Para ST 25/8 iPWM	Wilo Para ST 25/8 iPWM
031250-40-(38/40)-LT	70 m ²	35 kW	25 K	Wilo Para Maxo 25-180-08	Wilo Para ST 25/8 iPWM

It is possible to select two versions for each model indicated in the above table: one with mechanical flowmeter, another with digital VFS sensor.

- **Models with mechanical flowmeter:** the flowmeter has a measuring range of 8-28 or 8-38 l/m, default value according to the specific model selected. Product codes of these models show options 28 or 38 respectively. For example: Solo 2, High flow, with an exchanged power of 23 kW: **code 031250-40-38-LT**.
- **Models with digital VFS sensor:** all these models have the VFS sensor with a measuring range of 2-40 L/min. Product code of these models show the option 40. For example: Solo 2, High flow, with an exchanged power of 23 kW: **code 031250-40-40-LT**.

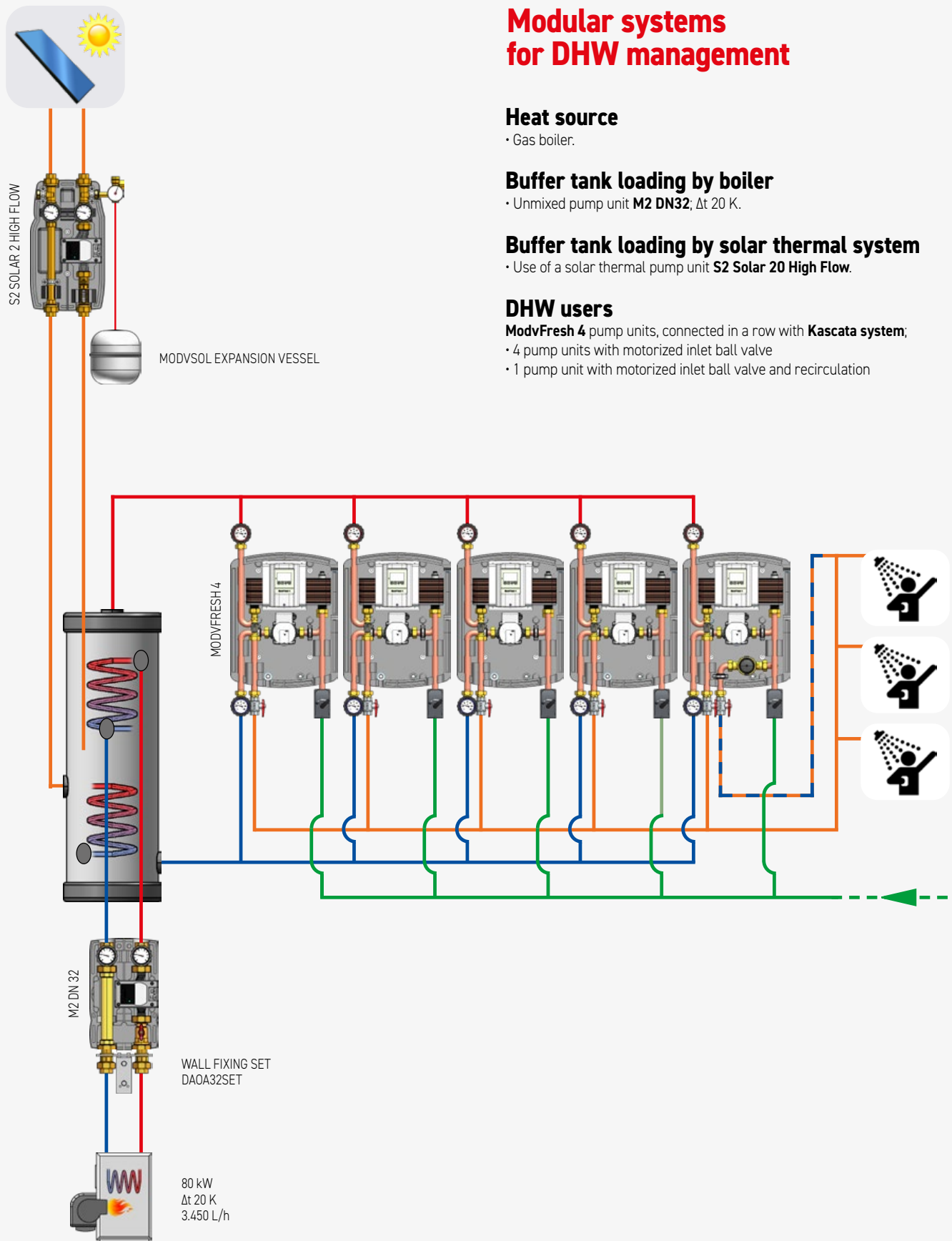

Modular systems for DHW management

Heat source

- Gas boiler.

Buffer tank loading by boiler

- Unmixed pump unit **M2 DN32**; Δt 20 K.

Buffer tank loading by solar thermal system

- Use of a solar thermal pump unit **S2 Solar 20 High Flow**.

DHW users

ModvFresh 4 pump units, connected in a row with **Kascata** system;

- 4 pump units with motorized inlet ball valve
- 1 pump unit with motorized inlet ball valve and recirculation

Note: the representations are to be considered just as an indication and they have no completeness pretension.

ModvFresh Basic

COMPACT HEAT EXCHANGE UNIT TO PRODUCE FRESH DOMESTIC HOT WATER (DHW)

Applications

For buffer tanks or similar, connected to solar thermal systems, wood, pellets, biomass boilers etc. when the stratification is not a primary requirement.

It provides fresh domestic hot water, avoiding phenomena of bacterial pollution, such as the legionnaire's disease etc., caused by stagnation of hot water. **ModvFresh Basic** is provided with a weld-braised plate heat exchanger made of stainless steel AISI 316.

Features

- Low head losses thanks to the asymmetrical heat exchanger. The activation of the circulating pump takes place with flow rates below 1 L/min through the intervention of a differential pressure switch;
- Four models available for flow rates from 14 to 25 L/min and powers respectively from 34 to 60 kW;
- The unit is supplied with a dedicated electrical box that simplifies the connections among the power supply, the circulating pump and the differential pressure switch;
- Heat-insulated heat exchanger with EPP insulation box (Dimensions: 250x143x218 mm).

Connections: 1" male (DHW); 1" female with union (buffer tank).
Centre distance 125 mm.

FIELD OF USE

For a maximum power of 60 kW and flow rate up to 25 L/min.
PN10. Max. temperature: 95°C



Dedicated box for electrical connections



Code 14 L/min, 1": **031150-34-14**
Code 16 L/min, 1": **031150-39-16**
Code 20 L/min, 1": **031150-50-20**
Code 25 L/min, 1": **031150-60-25**



CONTROL OF DHW

Hydraulic scheme

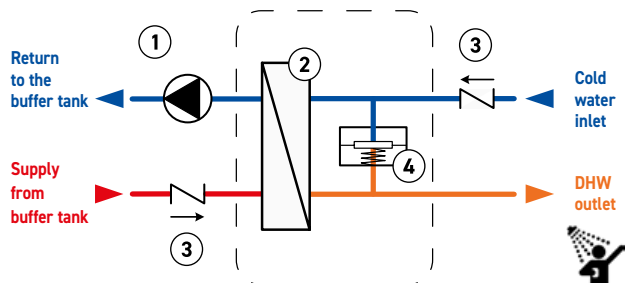

- ① Circulating pump (not included)
- ② Plate heat exchanger
- ③ Check valve (not included)
- ④ Differential pressure switch

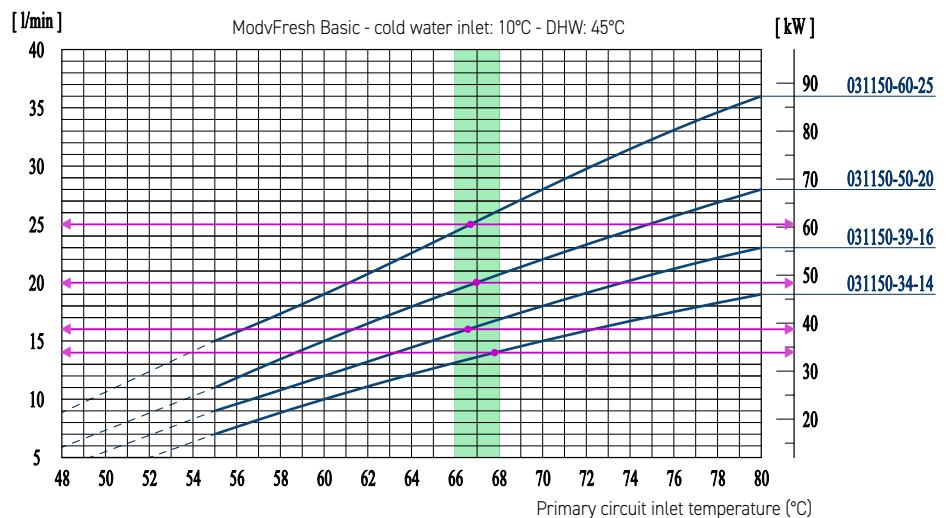

DHW PRODUCTION COMPACT HEAT EXCHANGE UNIT

Mixing kit

35÷60°C THERMOSTATIC MIXING KIT DESIGNED FOR MODV FRESH BASIC

Anti-scald thermostatic mixing valve for small applications. Asymmetric layout with "T" connection. Hot forged brass body. Yellow brass finish. Adjustable user temperature by means of a knob from 35°C up to 60°C.

- Maximum static pressure 10 bar (PN 10); dynamic pressure 5 bar
- Maximum ratio between pressures 2:1
- Maximum inlet temperature: 95°C
- Calibration temperature range: 35÷60°C
- Accuracy: ±2°C

Available external connections: 1" Male x 1" Swivel nut.
Centre distance 125 mm.

Code: **104721C-3560-1.8**



Available temperatures:

Adjustable temperature from **35°C to 60°C**



Layout:
Asymmetric "T"

Available Kvs:

1.8 = Maximum Kvs 1.8; up to 37 L/min (1.5 bar). Nominal Kv 1.77 (*)

(*) Tests carried out in our lab, with a differential pressure of 1 bar:
Th:65°C Tc:15°C Tmix:50°C (pos.3) → 29.5 L/min

PED 2014/68/EU 4.3

The safety anti-scald function automatically stops the hot water flow in case of failure of the cold water line.

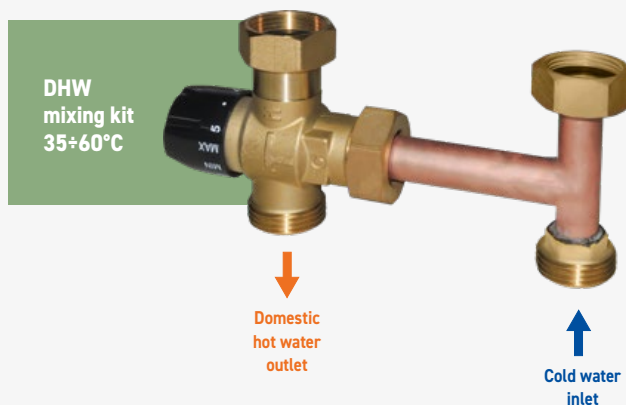

Hydraulic scheme

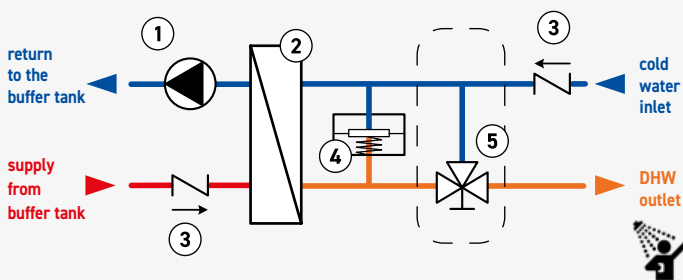

- ① Circulating pump (not included)
- ② Plate heat exchanger
- ③ Check valve (not included)
- ④ Differential pressure switch
- ⑤ Mixing kit

ModvFresh 1

PUMP UNIT TO PRODUCE FRESH DOMESTIC HOT WATER (DHW) WITH THERMOSTATIC CONTROL

Applications: with buffer tank connected to traditional thermal circuits, wood, pellet, biomass heat sources, etc., where the stratification phenomenon is not fundamentally required.

It provides domestic hot water, avoiding phenomena of bacterial pollution, such as the legionnaire's disease etc., caused by stagnation of hot water. ModvFresh 1 is provided with a weld-braised plate heat exchanger made of stainless steel AISI 316 and with a thermostatic mixing valve adjustable from 35 up to 60°C.

Two models are available, fully assembled and pre-wired:

- 50 kW, with variable flow rate up to 20 L/min, for domestic use installations;
- 100 kW, with variable flow rate up to 40 L/min, for small commercial installations;

with the followings features:

- High Efficiency circulating pump;
- Very low headlosses. The circulating pump starts to run with flow rates below 1 L/min thanks to a differential pressure switch;
- No electric wirings are required: the unit is pre-wired and factory tested;
- Easy temperature adjustment, by means of the graduated knob of the MultiMix thermostatic mixing valve;
- The heat exchanger can be easily removed in case of maintenance and/ or of cleaning;
- EPP insulation box (398 x 500 x 207 mm). A special back plate fixes the unit to the insulation box and allows a quick fitting to the wall or to the buffer tank;
- The pump unit is supplied with 3/4" Male connections (pipe-union).

Hydraulic scheme

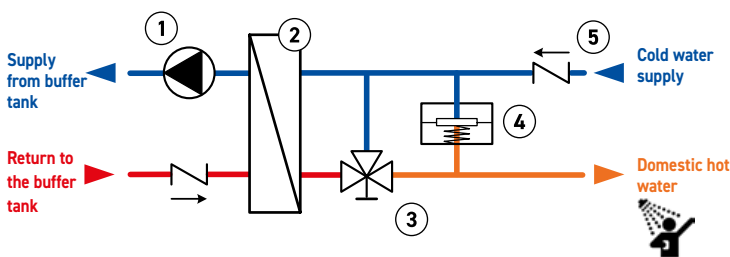

- | | |
|-----------------------------|--------------------------------|
| ① Circulating pump | ④ Differential pressure switch |
| ② Plate heat exchanger | ⑤ Check valve |
| ③ Thermostatic mixing valve | |

A special ball valve kit, on request (to be ordered), completes the installation.



Code 3/4": **031000SET**



Code 50 kW, 3/4": **031100-50-20**
Code 100 kW, 3/4": **031100-100-40**



Pump unit assembled with optional ball valve kit

CONTROL OF DHW



Technical features of ModvFresh 1

- Max allowed pressure: **10 bar**
- Working temperature: **2 ÷ 95 °C**
- Setting accuracy of Multimix Mixing Valve (model 50 kW): **±1°C (Kvs 2,5)**
- Setting accuracy of Multimix Mixing Valve (model 100 kW): **±2°C (Kvs 4,0)**
- Headloss in the secondary circuit at the flow rate of 20 L/min (model 50 kW): **3 mH₂O**
- Headloss in the secondary circuit at the flow rate of 40 L/min (model 100 kW): **9 mH₂O**

Minimum diameter size of the pipes: **DN20 (Cu 22x1)**.

Diagrams of the pump unit performances

The following diagrams relate the user flow rate and the water supply temperature from the buffer tank, depending on the temperature required for DHW. This allows to identify the minimum supply temperature needed to produce DHW at a required temperature and flow rate. Vice versa it is also possible to fix which is the maximum usable flow rate at the selected DHW temperature, at the available supply temperature.

FIELD OF USE

For a maximum power of **100 kW** and flow rate up to **40 L/min**.

Nominal supply temperature of the buffer tank: **65°C**.

Nominal inlet temperature from cold water supply: **10°C**.

Nominal temperature of DHW production **45°C**, adjustable up to **60°C**.

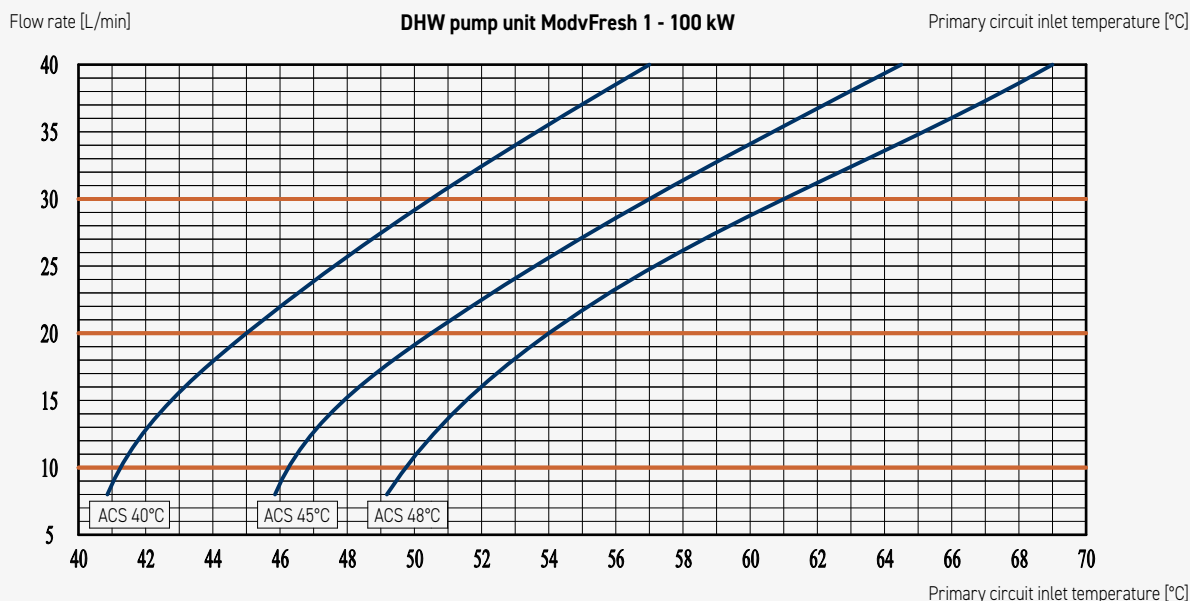
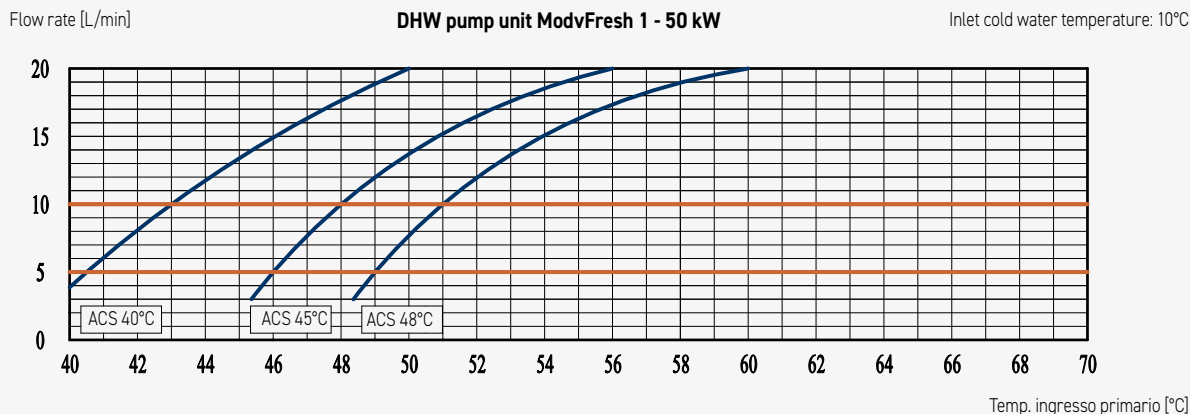

The buffer temperature must be almost 5 K higher than the desired temperature of the domestic hot water. Bigger temperature differences allow to extend the draw-off time. **Curves with different inlet temperatures of cold water are available on the website www.brvi.it.**



Performance calculation

From the website www.modvvs.com it is possible to download an Excel file suitable for the calculation of the performances of ModvFresh pump units.

Return temperature to the buffer tank

The return temperature to the tank is variable and depends on temperature and flow conditions. For example, if the supply temperature of the tank is high, the return temperature, after the thermal exchange into the heat exchanger, will be consequently and proportionally high. This effect is amplified with small user draw-off (limited heat exchange) and decreases with big user draw-off (high heat exchange). Therefore, if it is necessary not to compromise the stratification of the tank, it is recommended to install a thermic valve on the return line to the tank to load the tank at different heights and consequently at desired temperature.

ModvFresh 1 parallel connection

If high flow rates and powers are required it is possible to make a parallel connection of up to five **ModvFresh 1** (100 kW model) to supply up to 200 L/min and a nominal power of 500 kW without installing any other device such as electronic controllers, motorized valves, flow sensors, etc.

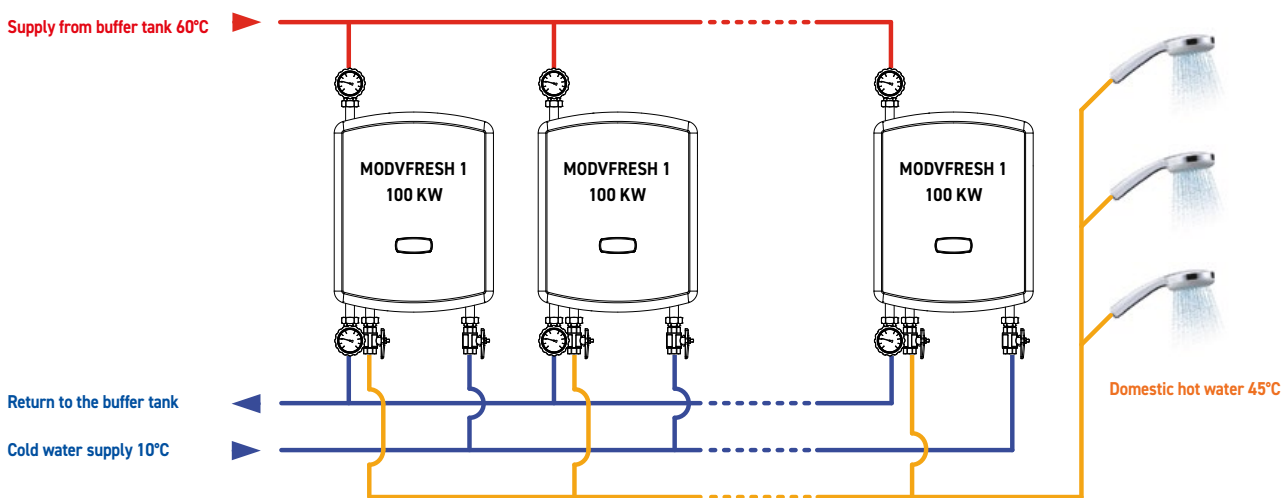

The connecting diagram is particularly suitable for installations where the user flow request is nearly constant, to optimize the power consumption of the circulating pumps that are all activated with minimum flow rate; temperature control is in any case guaranteed throughout the range of use of the flow.

The following table lists the main operating parameters with **ModvFresh 1** connected in parallel (data are obtained with a cold water inlet of 10°C). For a precise sizing consult our Technical Department.

ModvFresh 1 100 kW pump unit to produce DHW: parallel installation

Requested flow rate [l/min]	Number of ModvFresh 1 100 kW	Selected hot water temperature [°C]	Needed supply temperature (buffer tank) [°C]	Exchanged power [kW]	Minimum diameter of the pipes [mm]
80	2	50	70	224	28 x 1,5
120	3	50	70	336	35 x 1,5
160	4	50	70	448	35 x 1,5
200	5	50	70	560	42 x 1,5

FIELD OF USE

For a maximum power of 500 kW and flow rate up to 200 L/min.

Nominal supply temperature of the buffer tank: 65°C.

Nominal inlet temperature from cold water supply: 10°C.

Nominal temperature of DHW production: 45°C, adjustable up to 60°C.

Temperature stability ±4°C.

Return temperature to the buffer tank: see "ModvFresh 1"

ModvFresh 2 T

PUMP UNIT TO PRODUCE FRESH DOMESTIC HOT WATER (DHW) WITH THERMOSTATIC CONTROL

Applications: with buffer tanks connected to traditional wood, pellet, biomass, etc, thermal circuits, where the phenomenon of temperature stratification is not fundamentally required.

It provides domestic hot water, avoiding phenomena of bacterial pollution, such as the legionnaire's disease, due to the stagnation of the hot water. The compact size allows an easy installation even on small cylinders.

ModvFresh 2 T is provided with a weld-braised plate heat exchanger made of stainless steel AISI 316 and with a thermostatic mixing valve, adjustable from 35 up to 60°C

Two models are available, fully assembled and pre-wired:

- 50 kW, with flow rate up to 20 L/min, for domestic use installations;
- 70 kW, with flow rate up to 30 L/min, for heat pumps up to 18 L/min;

Selection chart to produce DHW at 45°C with cold water at 10°C

Heat source	Buffer tank temperature	Flow rate	Sample code
Heat pump	52°C	15 L/min	031350-70-30
	55°C	18 L/min	031350-70-30
Gas, biomass, boiler	60°C	20 L/min	031350-50-20
	68°C	30 L/min	031350-70-30

Features

- High Efficiency circulating pump;
- Very low head losses. The circulating pump starts to run at flow rates below 1.5 L/min thanks to a flow switch;
- No electric wirings are required: the unit is pre-wired and factory tested;
- Easy temperature adjustment, by means of the graduated knob of the thermostatic mixing valve;
- The heat exchanger can be easily removed in case of maintenance and/of cleaning;
- EPP insulation box (277 x 417 x 137 mm). A special back plate fixes the unit to the insulation box and allows a quick fitting to the wall or to the cylinder;
- The pump unit is supplied with 3/4" Male connections (pipe-union).

Hydraulic scheme

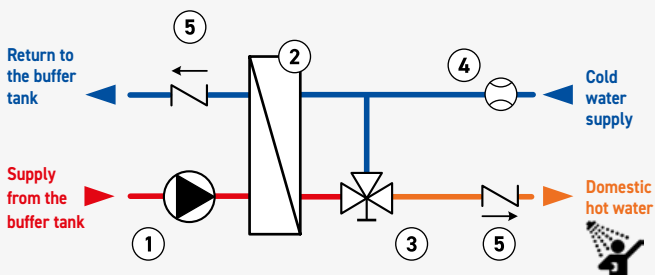

- ① Circulating pump
- ② Plate heat exchanger
- ③ Thermostatic mixing valve
- ④ Flow switch
- ⑤ Check valve



Code 50 kW, 3/4": **031350-50-20**
Code 70 kW, 3/4": **031350-70-30**

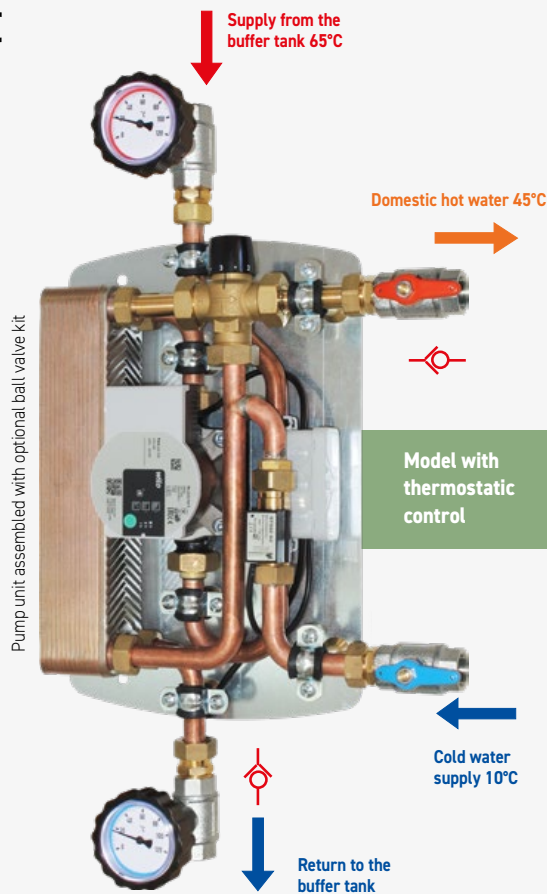

A special ball valve kit, on request (to be ordered), completes the installation.

Code 3/4": **031000SET**

Technical features of ModvFresh 2 T

- Maximum allowed pressure (without water hammer): **10 bar**
- Working temperature: **2 ÷ 95°C**
- Head loss in the secondary circuit at the flow rate of 20 L/min (50 kW model): **3 mH₂O**
- Head loss in the secondary circuit at the flow rate of 30 L/min (70 kW model): **6.5 mH₂O**

Size of the connections:
min. **DN20** (Cu 22x1) near the cylinder.

FIELD OF USE

For a maximum power of 70 kW and flow rate up to 30 L/min.

Nominal supply temperature of the buffer tank: 65°C.

Nominal temperature of the water supply: 10°C.

Nominal temperature of DHW production: 45°C, adjustable from 35°C up to 60°C.

Diagrams of the pump unit performances

The following diagrams relate the user flow rate and the water supply temperature from the buffer tank, depending on the temperature required for DHW. This allows to identify the minimum supply temperature needed to produce DHW at a required temperature and flow rate. Vice versa it is also possible to fix which is the maximum usable flow rate at the selected DHW temperature, at the available supply temperature.

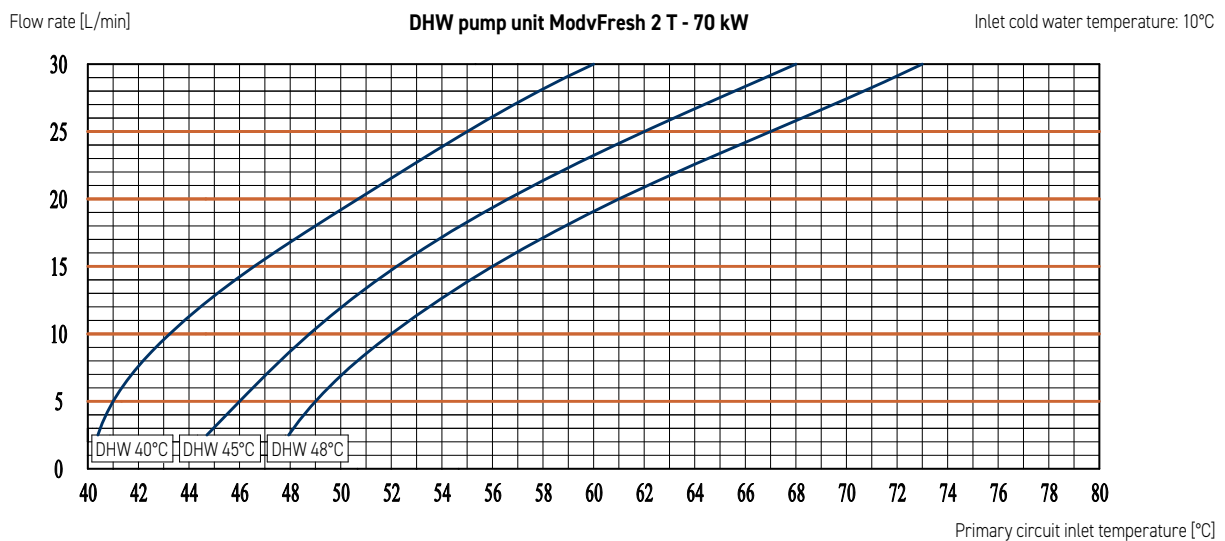
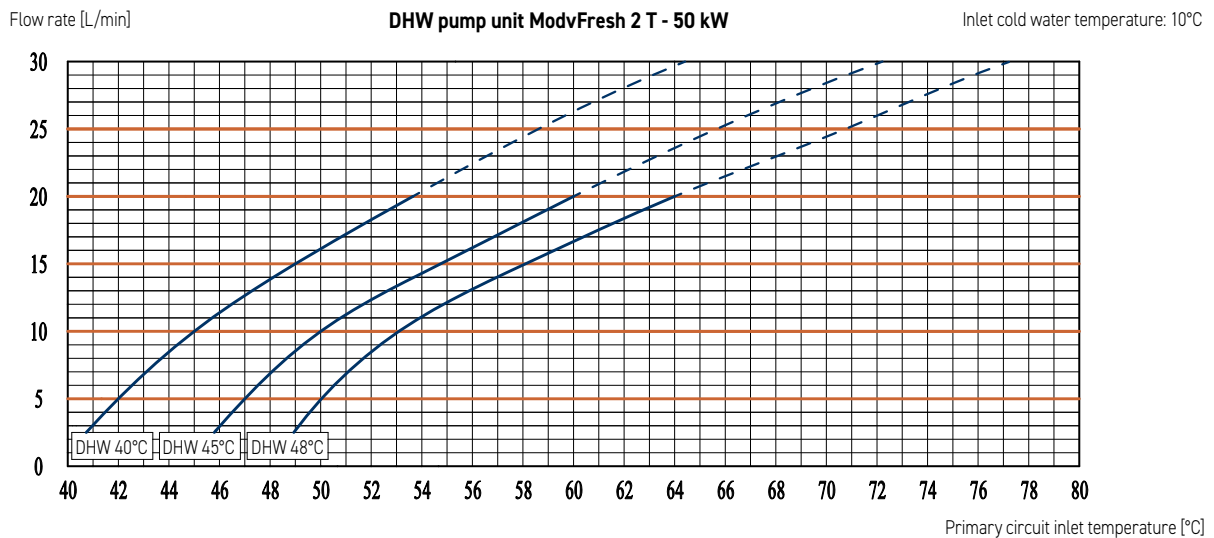

The buffer temperature must be almost 5 K higher than the desired temperature of the domestic hot water. Bigger temperature differences allow to extend the draw-off time. **Curves with different inlet temperatures of cold water are available on the website www.brvi.it.**



Performance calculation

From the website www.modvvs.com it is possible to download an Excel file suitable for the calculation of the performances of ModvFresh pump units.

ModvFresh 2

PUMP UNIT TO PRODUCE FRESH DOMESTIC HOT WATER (DHW) WITH ELECTRONIC CONTROL

Applications: with buffer tanks connected to standard heating systems, heat pumps, solar thermal and biomass systems. It provides DHW, avoiding phenomena of bacterial pollution, such as the legionnaire's disease, due to stagnation of heated water. The compact size allows an easy installation even on small cylinders.

The unit, by means of a dedicated electronic controller, modulates the speed of the primary high efficiency circulating pump, from a minimum speed of 10% up to 100%, in order to provide always a precise temperature of exploitation (e.g. 45°C). The variation of the requested flow is suddenly recorded by a digital sensor that gives the inputs of flow and temperature to the controller, which modulates the speed of the circulating pump accordingly.

Two models are available, fully assembled and pre-wired:

- 50 kW, with flow rate up to 20 L/min, for domestic use installations;
- 70 kW, with flow rate up to 30 L/min, for heat pumps up to 18 L/min;

Selection chart to produce DHW at 45°C with cold water at 10°C

Heat source	Buffer tank temperature	Flow	Return temperature	Sample code
Heat pump	52 °C	15 l/min	33 °C	031300-70-30
	55 °C	18 l/min	31 °C	031300-70-30
Gas boiler, biomass, solar thermal	60 °C	20 l/min	33 °C	031300-50-20
	68 °C	30 l/min	29 °C	031300-70-30

Features

- High Efficiency circulating pump;
- Delivered hot water temperature: 45°C with supply water temperature at 10°C.
- The DHW temperature is adjustable every single degree from 30°C up to 70°C;
- A big surface weld-braised plate heat exchanger made of stainless steel AISI 316 guarantees a remarkable thermal exchange that allows a water return to the buffer tank at a temperature up to 25°C;
- The heat exchanger can be easily removed in case of maintenance and/or cleaning;
- Metering of used energy by means of the digital sensor (cold water temperature fixed at 10°C);
- EPP insulation box (277 x 417 x 137 mm). A special back plate fixes the unit to the insulation box and allows a quick fitting to the wall or to the buffer tank;
- The pump unit is supplied with 3/4" Male connections (pipe-union).
- **Version with electronic controller designed for the control of the recirculation line: pre-wired external box with electric wirings for the control of the circulating pump and the relevant contact temperature sensor.**



Kit for the recirculation loop with EcoCirc Pro 15-3/65B circulating pump and connections to check valve and to isolating valve

Code 1": **031300-CIRC**



A special ball valve kit, on request (to be ordered), completes the installation.

Code 3/4": **031000SET**



Units without recirculation control:

Code 50 kW, 3/4": **031300-50-20**

Code 70 kW, 3/4": **031300-70-30**

Units with recirculation control:

Code 50 kW, 3/4": **031310-50-20**

Code 70 kW, 3/4": **031310-70-30**



On demand, a test report of the VFS is available. It shows the result of the tests made directly in the Grundfos Lab.

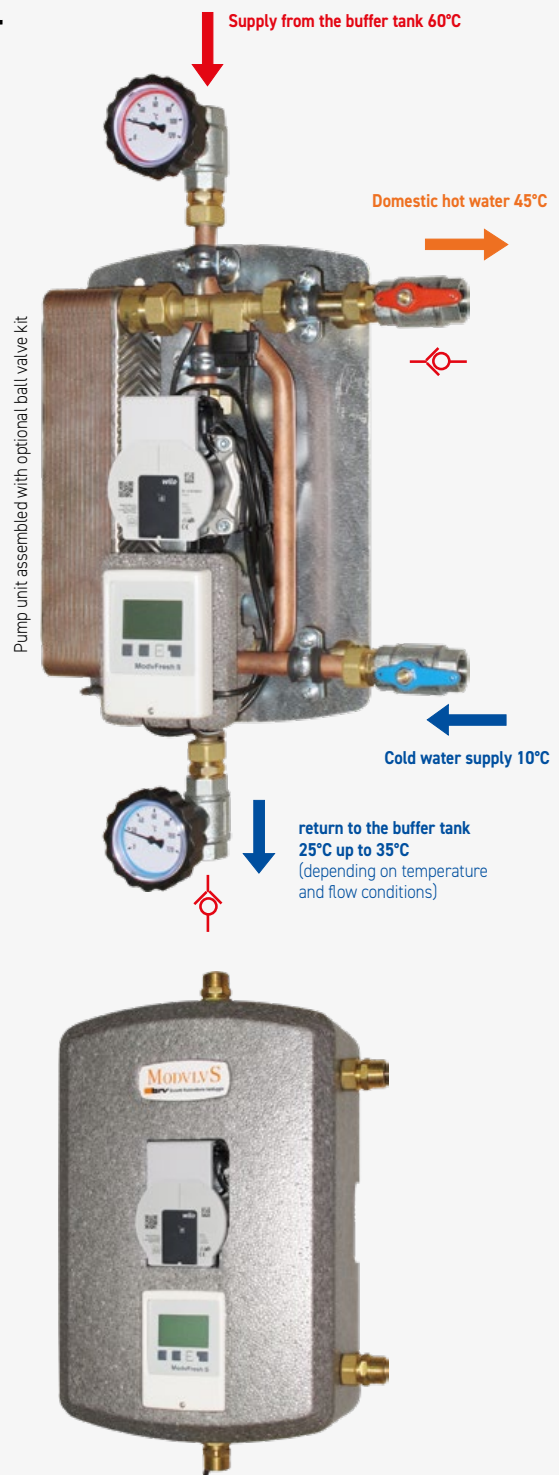

Technical features of ModvFresh 2

- Maximum allowed pressure (without water hammer): **10 bar**
- Working temperature: **2 ÷ 95°C**
- Headloss in the secondary circuit at the flow rate of 20 L/min (50 kW model): **3 mH₂O**
- Headloss in the secondary circuit at the flow rate of 30 L/min (70 kW model): **6,5 mH₂O**

Size of the connections:
min. **DN20** (Cu 22x1) near the cylinder.

FIELD OF USE

For a maximum power of 70 kW and flow rate up to 30 L/min.
Nominal supply temperature of the buffer tank: 60°C.
Nominal inlet temperature from cold water supply: 10°C.
Nominal temperature of DHW production: 45°C, adjustable from 30°C up to 70°C.

Diagrams of the pump unit performances

The following diagrams relate the user flow rate and the water supply temperature from the buffer tank, depending on the temperature required for DHW. This allows to identify the minimum supply temperature needed to produce DHW at a required temperature and flow rate. Vice versa it is also possible to fix which is the maximum usable flow rate at the selected DHW temperature, at the available supply temperature.

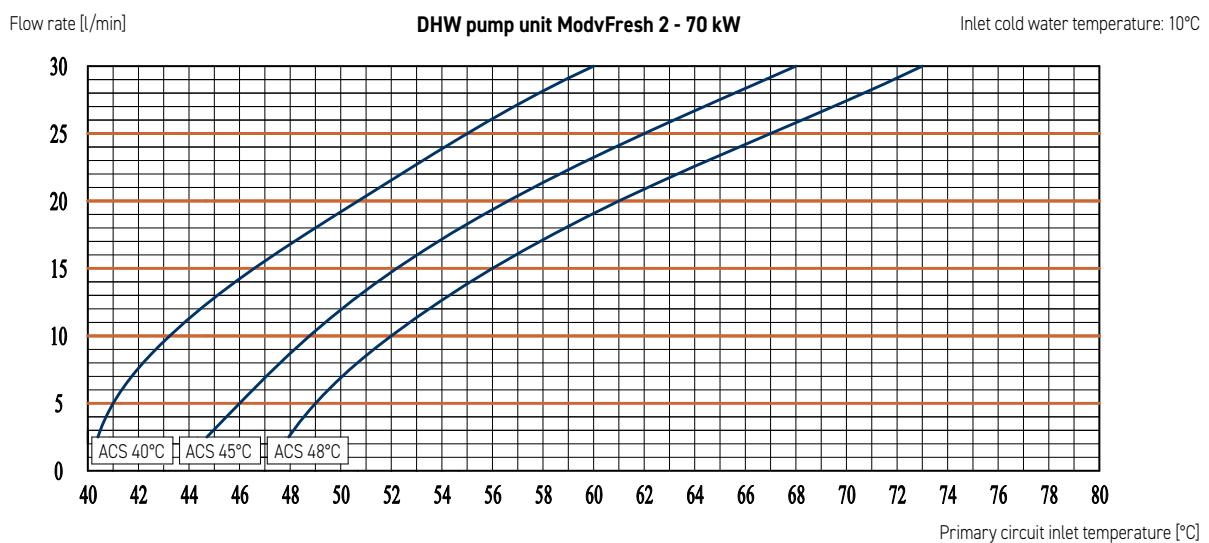
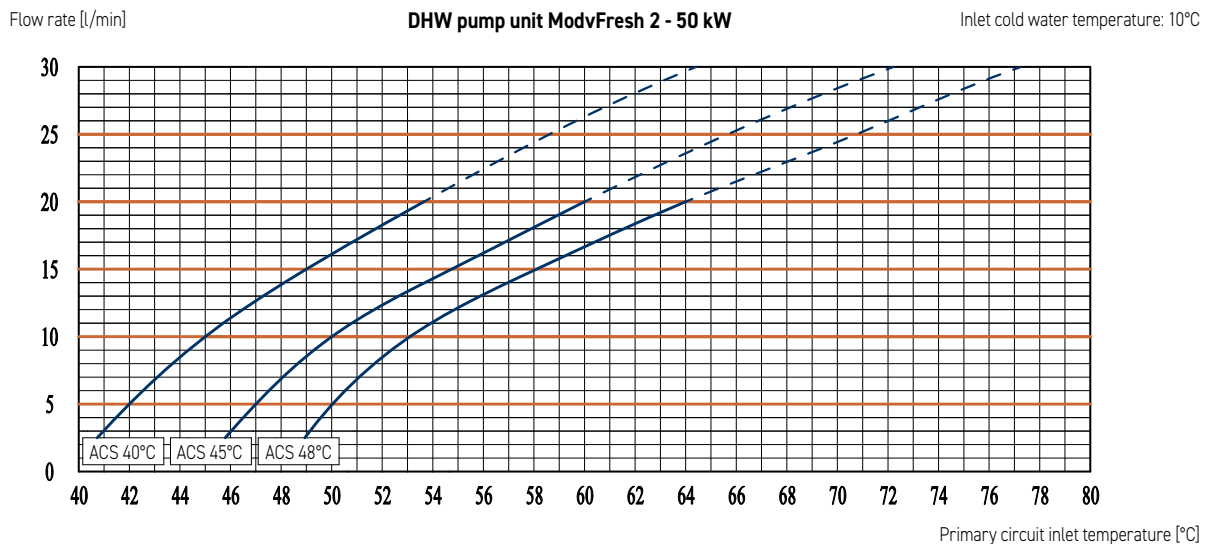

The buffer temperature must be almost 5 K higher than the desired temperature of the domestic hot water. Bigger temperature differences allow to extend the draw-off time. **Curves with different inlet temperatures of cold water are available on the website www.briv.it.**



Performance calculation

From the website www.modvvs.com it is possible to download an Excel file suitable for the calculation of the performances of ModvFresh pump units.

DHW PRODUCTION HIGH EFFICIENCY AND ADDITIONAL FUNCTIONS

ModvFresh 4

PUMP UNIT TO PRODUCE FRESH DOMESTIC HOT WATER (DHW) WITH ELECTRONIC CONTROL. CONTROL OF RETURN TEMPERATURE OF PRIMARY LOOP. THERMOSTAT FUNCTION

Applications: with buffer tanks connected to standard heating systems, heat pumps, solar thermal and biomass systems. It provides DHW, avoiding phenomena of bacterial pollution, such as the legionnaire's disease, due to stagnation of heated water. Control and management of the integrative heat source of the buffer tank to maintain the minimum storage temperature required. Optimal control of the return temperature to the tank thanks to the diverting valve control (optional valve).

The unit, by means of a dedicated electronic controller, modulates the speed of the primary high efficiency circulating pump, from a minimum speed of 10% up to 100%, in order to provide always a precise temperature of exploitation (e.g. 45°C). The variation of the requested flow is suddenly recorded by a digital sensor that gives the inputs of flow and temperature to the controller, which modulates the speed of the circulating pump accordingly.

Three models available, fully pre-assembled and pre-wired

- 50 kW, with flow rate from 1 up to 20 L/min, suitable for domestic use installations;
- 100 and 125 kW, with flow rate from 2 up to 40 L/min, suitable for small commercial installations.

Features

- High efficiency circulating pump and control of return temperature of primary loop by a diverting valve (optional);
- Function of thermostat integration of the buffer tank: it activates the energy source in case water temperature of the buffer tank does not comply with set up timetables;
- External sensor boxes to connect easily external sensors and relays.
- Delivered DHW temperature: 45°C with supply cold water temperature of 10°C. Consequently the power is about 98 kW at the flow rate of 40 L/min;
- The 125 kW model allows to operate with lower temperatures in the buffer tank, or to deliver the same flow rate at a higher temperature;
- Anyway the temperature of the DHW is adjustable every single degree up to 70°C;
- The minimum required temperature of the heat exchanger is 60°C in order to guarantee the declared performances to the maximum flow (with 35 K thermal Δt);
- A big surface plate weld-braided heat exchanger made of stainless steel AISI 316 guarantees a remarkable thermal exchange that allows a water return to the puffer with a temperature up to 15°C. This favours a perfect yield of the solar contribution or of the heat pump;
- Available with or without recirculation circulating pump (functioning "on request" or "by time bands"; adjustable temperature up to 40°C);
- Synchronous high efficiency recirculation circulating pump (in the models where it is present);
- The heat exchanger can be easily removed in case of maintenance and/of cleaning;
- A digital sensor allows an accurate power recording (total, yearly, monthly, weekly and daily);
- EPP insulation box (398 x 500 x 207 mm). A special back plate fixes the unit to the insulation box and it allows a quick fitting to the wall or to the buffer tank;
- The pump unit is supplied with 3/4" Male connections (pipe-union).

A special ball valve kit, on request (to be ordered), completes the installation.

For units without recirculation:

Code 3/4": **031000SET**

For units with recirculation:

Code 3/4": **031010SET**



Units without recirculation:

Code 50 kW, 3/4": **031400-50-20**

Code 100 kW, 3/4": **031400-100-40**

Code 125 kW, 3/4": **031400-125-40**



Units with recirculation:

Code 50 kW, 3/4": **031415-50-20**

Code 100 kW, 3/4": **031415-100-40**

Code 125 kW, 3/4": **031415-125-40**



On demand, a test report of the VFS is available. It shows the result of the tests made directly in the Grundfos Lab.

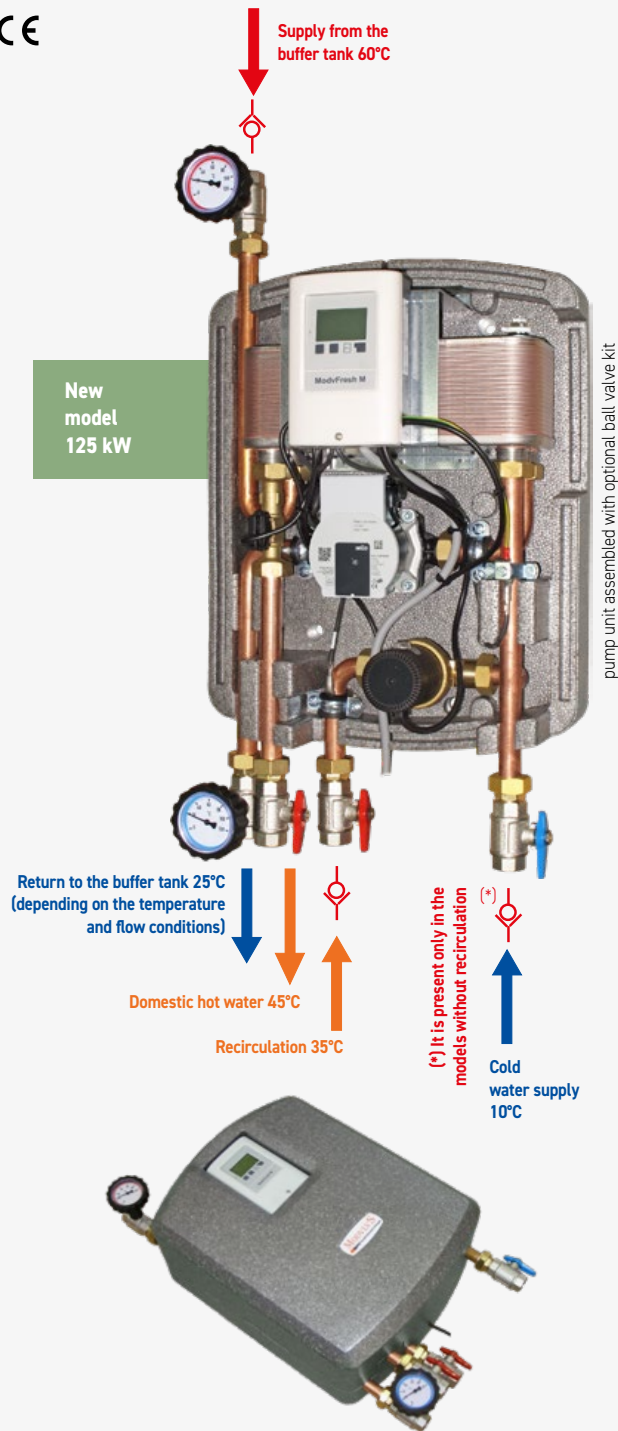

ModvFresh 4 different hydraulic schemes

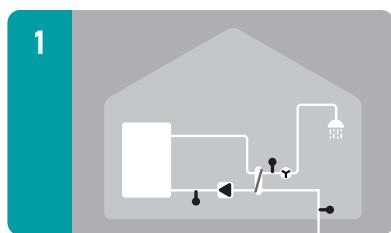

DHW production

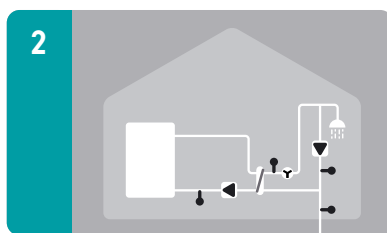

DHW production with recirculation

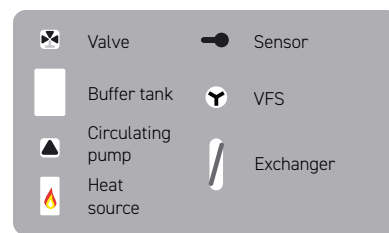

Preset schemes of ModvFresh 4 controller can be enriched in an easy and flexible way by two additional functions: additional heating with thermostat function and/or control of return temperature to buffer tank by a diverting valve (optional). To make it easy, hereafter scheme shows the model with active recirculation, however it is also possible to configure the same scheme without recirculation.

Scheme 2 + 

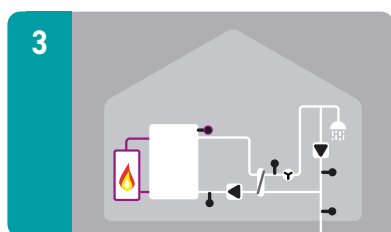

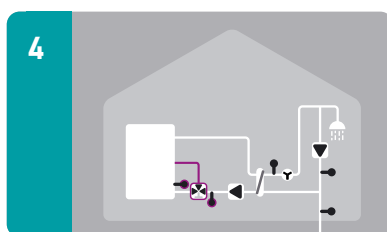

DHW production with recirculation and additional thermostat function

Scheme 2 + 



DHW production with recirculation and control of return temperature

Scheme 2 +  + 

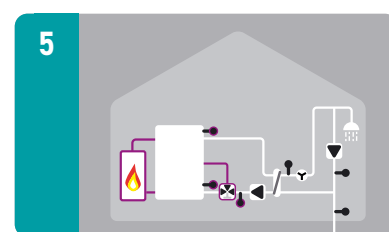

DHW production with recirculation, additional thermostat function and control of return temperature (*)



(*) **Note:** in scheme 5, the controller considers 25°C as fixed temperature inside the buffer tank to manage the deviation. In case you would need to read the temperature and process the value in the controllers, it is necessary to order separately a TT/S2 sensor and to wire it to sensor box.

Technical features of ModvFresh 4

- Maximum allowed pressure (without water hammer): **10 bar**
 - Working temperature: **2 ÷ 95°C**
 - Headloss in the secondary circuit at the flow rate of 20 L/min (50 kW model): **4 mH₂O**
 - Headloss in the secondary circuit at the flow rate of 40 L/min (100 kW model): **6 mH₂O**
 - Headloss in the secondary circuit at the flow rate of 40 L/min (125 kW model): **5 mH₂O**
 - Headloss in the recirculation circuit (at the flow of 5 L/min): **0,3 mH₂O**
- Min. diameter size of the pipes: DN20 (Cu 22x1); DN15 for the recirculation line.**

FIELD OF USE

For a maximum power of 125 kW and flow rate up to 40 L/min.
 Nominal supply temperature of the buffer tank: 60°C.
 Nominal inlet temperature from cold water supply: 10°C.
 Nominal temperature of DHW: 45°C, adjustable from 30°C up to 70°C.
 Recirculation line temperature adjustable from 10°C up to 40°C.

Performance curve of the recirculation circulating pumps (if present)

High efficiency synchronous circulating pump.

The speed control is always variable by means of the selector; you can find the speeds corresponding to the 7 reference marks along the selector scale.

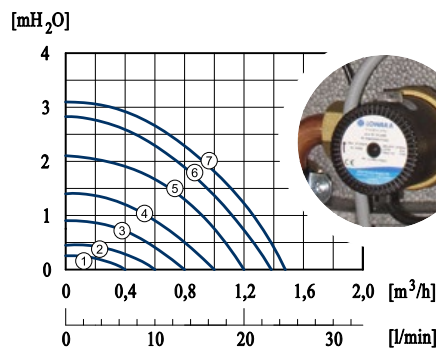

Sensor Box

For an easy and effective connection of the temperature sensors, valves or circulating pumps it is not necessary to act on the control unit, but it is sufficient to plug the cables in the automatic connectors of the sensor box.



Flow rate limitation fitting

1" x 3/4" male fitting equipped with flow limiter 38 L/Min. To be installed on the DHW output of the ModvFresh 4 100 kW units.

Code: **DBOJ031000-38/S**



Diagrams of the pump unit performances

The following diagrams relate the user flow rate and the water supply temperature from the buffer tank, depending on the temperature required for DHW. This allows to identify the minimum supply temperature needed to produce DHW at a required temperature and flow rate. Vice versa it is also possible to fix which is the maximum usable flow rate at the selected DHW temperature, at the available supply temperature.

The buffer temperature must be almost 5 K higher than the desired temperature of the domestic hot water. Bigger temperature differences allow to extend the draw-off time. **Curves with different inlet temperatures of cold water are available on the website www.briv.it.**

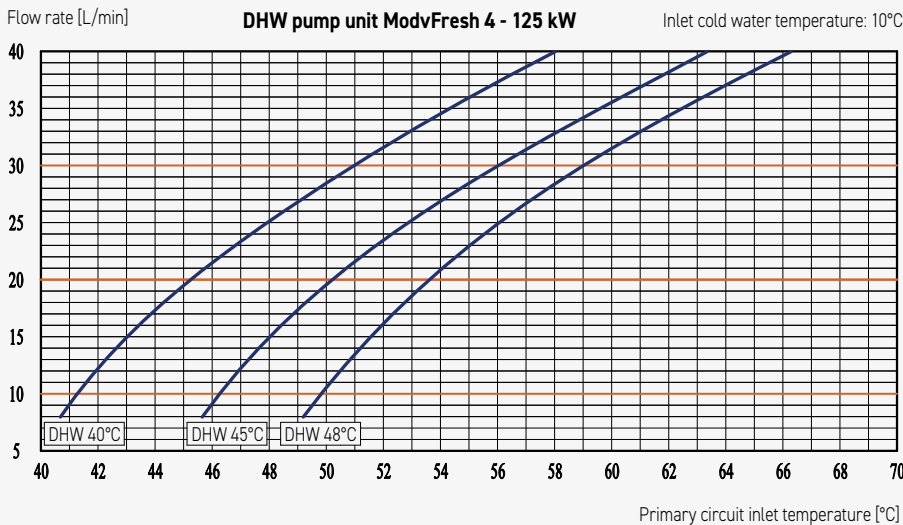
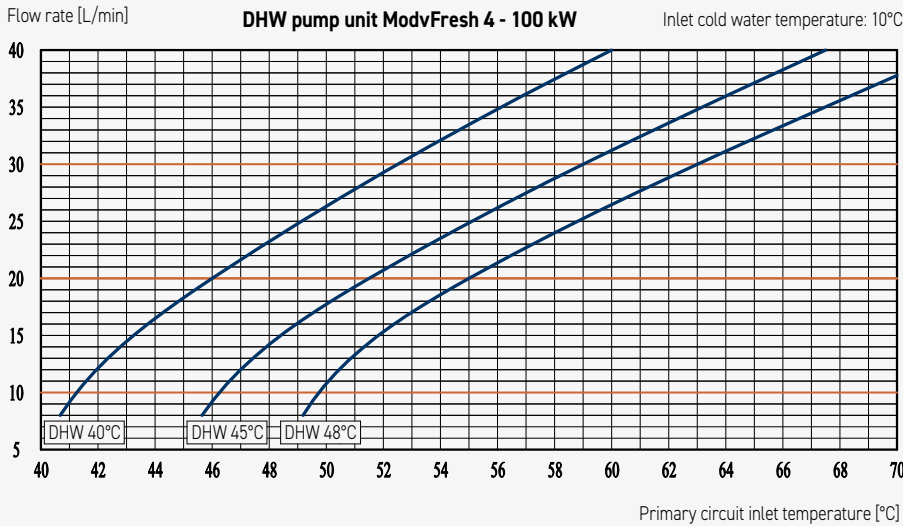
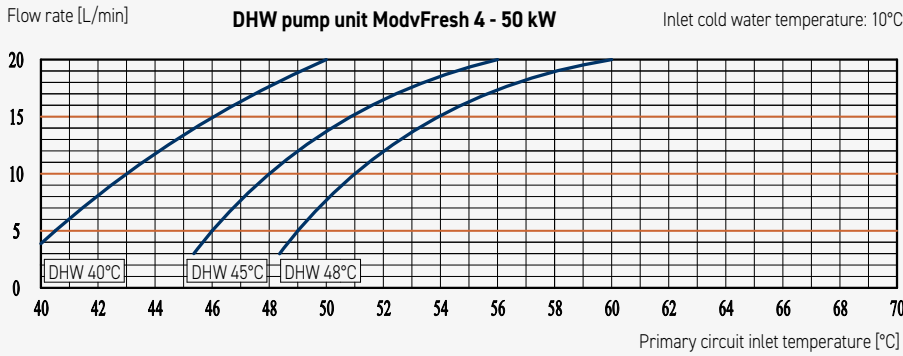

Art. 1090
3-way zone valve

Motorized 3-way zone valve with spring return for closed hydraulic systems. Use: heating, cooling and solar thermal (glycol max. 50%).

Available external connections:
1" Male flat seal.

For further info please look up product description within "ModvSol - Equipments and accessories" section.



TT/S2 temperature sensor

PT1000 dip temperature sensor with guaranteed accuracy of detection, according to DIN EN60751 (IEC751); it ensures a precise acquisition of the temperature and an excellent exploitation of the energy. With silicone cable 2 m long, 180°C.

For further info please look up product description within "ModvSol - Differential Solar Controllers" section.

CONTROL OF DHW



Performance calculation

From the website www.modvvs.com it is possible to download an Excel file suitable for the calculation of the performances of ModvFresh pump units.

ModvFresh Kascata

SYSTEM TO CONNECT IN CASCADE SEVERAL DHW MODVFRESH 4 MODULES FOR INSTALLATIONS REQUIRING HIGH POWER AND FLOW RATE OR WITH MEDIUM-TEMPERATURE HEAT SOURCES (HP)

ModvFresh Kascata is an innovative control logic that allows to connect in cascade multiple standard ModvFresh 4 pump units for the production of domestic hot water, with the possibility of obtaining a maximum flow rate and an exchanged thermal power equal to the sum of the performance of the individual modules.

The system finds application with buffer tanks of large plants connected to solar thermal circuits, biomass boilers (e.g. pellets and wood), etc, and guarantees the production of instantaneous domestic hot water avoiding bacterial contamination phenomena (such as Legionella) due to stagnation of heated water.

The entire system is managed thanks to a bus connection that connects the control units of the individual ModvFresh 4 units. The control units by reading the flow rate coming from the hot water system, consequently activate the necessary DHW modules, by controlling the respective actuators on the cold water inlets. The Kascata system thus proves to be truly flexible and can be designed and built with a modular approach, according to the specific needs of the system.

The control logic also allows you to optimize the operation in combination with medium-temperature heat sources, such as for example heat pumps (HP). By connecting in cascade the ModvFresh modules it is possible to maximize the efficiency, making the most of the thermal energy available in the buffer tank. It is possible to adapt the configuration to the project data, which generally are different from one plant to another for temperature and storage volume, flow rates and required temperature in use.



Codes: see table

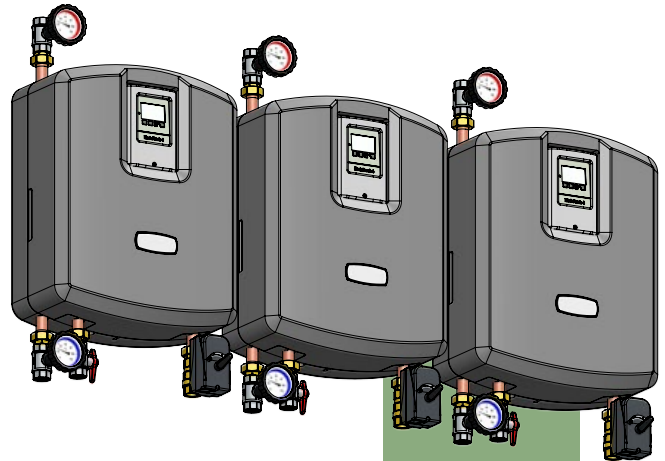

CE

Pre-wired modules: simple and quick modular installation

CONTROL OF DHW

Hydraulic scheme

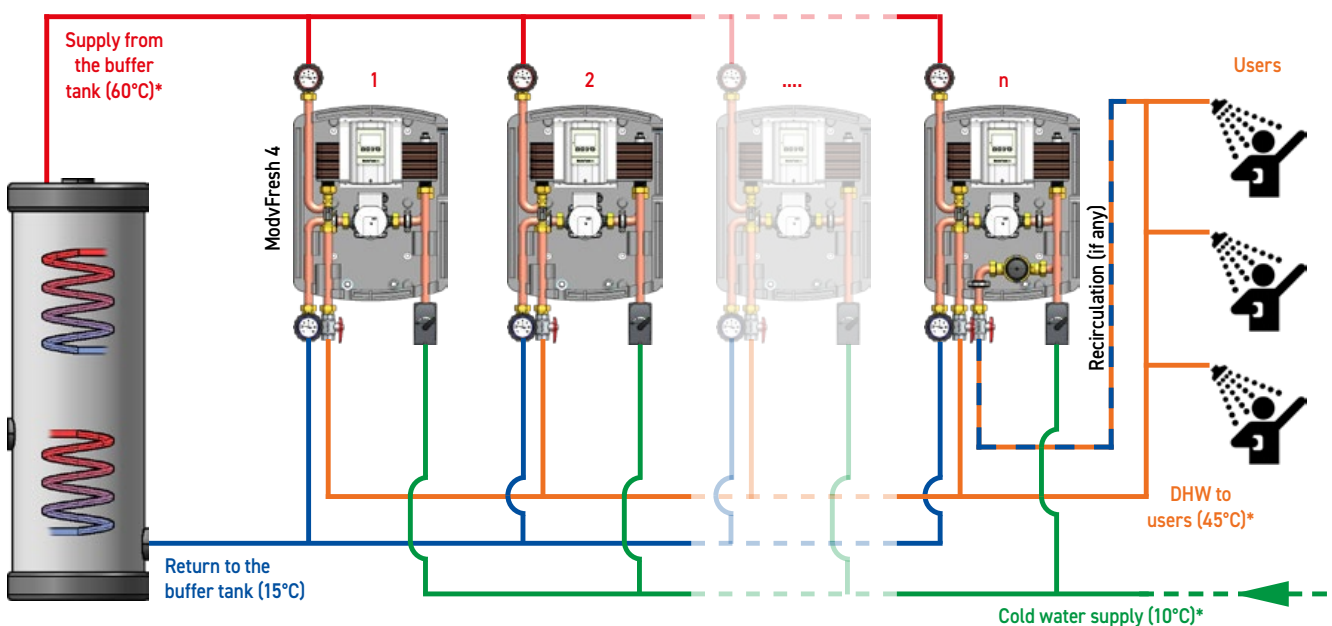

Note: Approximate schematic only. Temperature values marked with an asterisk (*) have to be considered as nominal.

Main technical features

- Control of the return temperature to the water tank optimized by every working unit, thanks to the function of speed modulation of the primary circulating pump. This adjustment allows to decrease the return water temperature to the buffer tank up to 15°C: for this reason no devices for the control of the stratified return are needed;
- Wide field of application: suitable for commercial installations, hotels, hospitals, sport halls etc;
- "Routine" function that starts up uniformly every DHW unit, on the base of the worked time, allowing a working load equally distributed on the installed units;
- Possibility to enlarge the system (later on) with additional units, in case of increase of power and flow rate request;
- Progressive working of the system without water hammers, thanks to the use of motorized starting valves. The unit is started up or switched off in 20 seconds;
- Possibility to control a recirculation line using, as last element of the system, a ModvFresh 4 unit with recirculation. Recirculation time bands, temperature and flow rate can be set directly on each device;
- Metering of the heat quantity produced by every unit of DHW system.

Quick and easy installation: ModvFresh 4 modules are supplied already pre-wired. It is sufficient to supply power and connect the CAN-Bus cables to the appropriate connection box.

FIELD OF USE

Nominal supply temperature of the buffer tank: 60°C.
Nominal inlet temperature from cold water supply: 10°C.
Nominal temperature of DHW production: 45°C, adjustable from 30°C up to 70°C.
Recirculation line temperature: adjustable from 10°C up to 40°C.

Motorized zone valve (cold water inlet)

Yellow brass finish.
Threaded connections ISO 228 (DIN 259 BSP 2779).

- Quick "clip" connection to the valve for actuator;
- Power supply 230 V AC.

PN 32. Working pressure: 16 bar.
Max differential pressure: 10 bar.
Fluid temperature: -20÷120°C



On/off actuator

2 points actuator: M11 2P, 5 Nm, 20"

Flow rate limitation fitting

1" x 3/4" male fitting equipped with flow rate limiter 38 L/Min. To be installed on the DHW output of the ModvFresh 4 100 kW units.



CAN-Bus connection box

Connection box for shielded CAN-Bus cables. It allows to connect up to 4 in cascade ModvFresh 4 modules. For systems that require more modules a second connection box is needed.



Example of system with 4 modules + 1 with recirculation

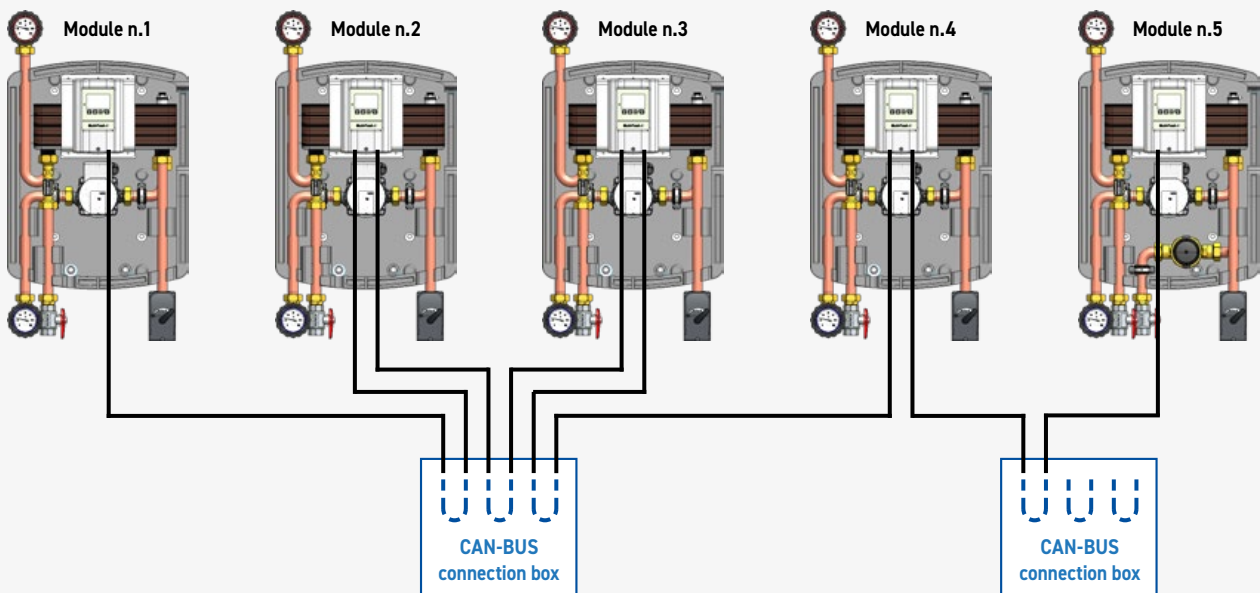

System start-up and selective activation of the units

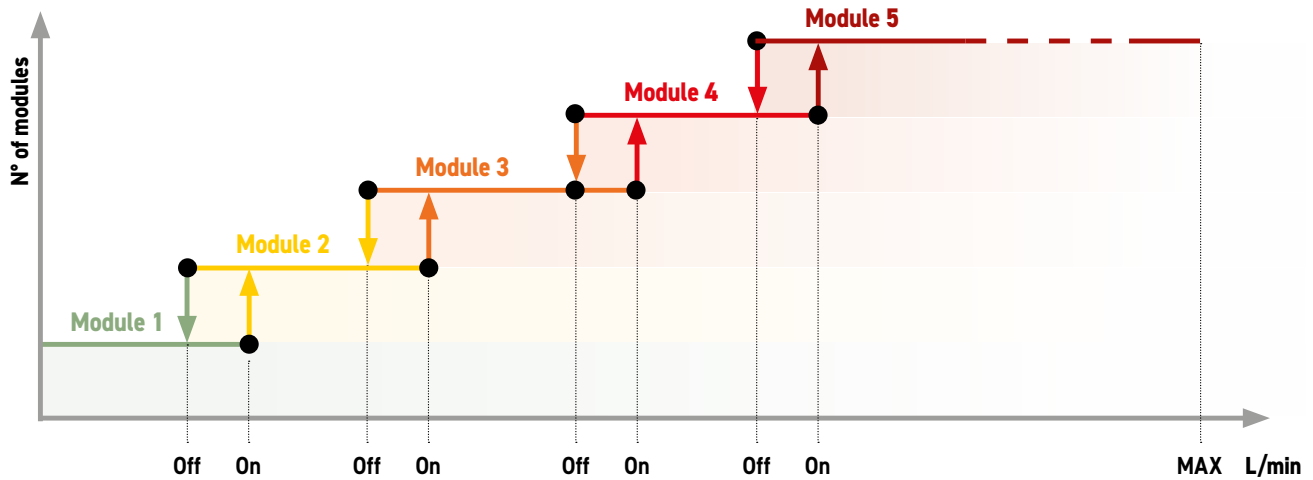

In the start-up mode, without any user request, the first ModvFresh is in stand-by because the isolating valve, controlled by the Kascata system, is usually open. After the request from the first user, the first ModvFresh is activated and it starts to produce fresh domestic hot water.

Then, according to the increase of users and, consequently, of the required flow rate, the VFS sensors progressively register this increase and the Kascata system, that controls the opening of the isolating valves placed on the cold water inlet of each unit, consequently activates the number of units necessary to guarantee the required flow rate. Therefore, according to this working mode, as the demand for hot water changes, the individual modules are activated or deactivated.

System stop and routine function

Once the user request stops, the Kascata system operates the closing of all the isolating valves except the one of the priority unit. It is important to say that it does not coincide necessarily with the unit number 1, because it is the routine function that determines, time by time and according to the worked time of every unit, which one has to be kept in stand-by. When a new user request is coming, the unit which, in that particular moment, is considered primary will start up delivering again the flow and, if necessary, the Kascata system will operate on the insulating valves of other units, bringing the system back to the previously described operating condition.

The importance of the routine function is fundamental, in fact it allows a balanced load on all the units of the system.

Recirculation line

If the design of the system requires a recirculation line, it is possible to manage this function by installing, as the last element of the cascade (to simplify the hydraulic connections), a ModvFresh unit with recirculation. The starting time bands and the recirculation line temperature can be set directly on the built-in controller of the special unit.

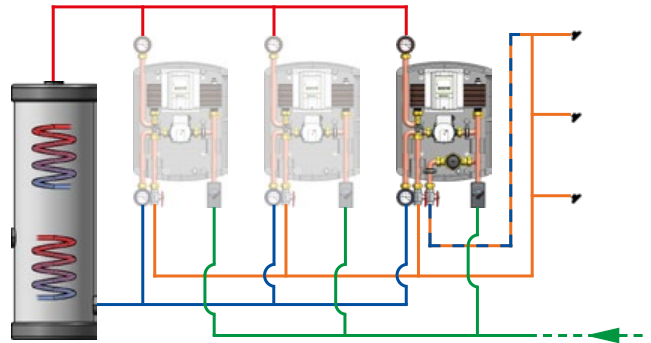
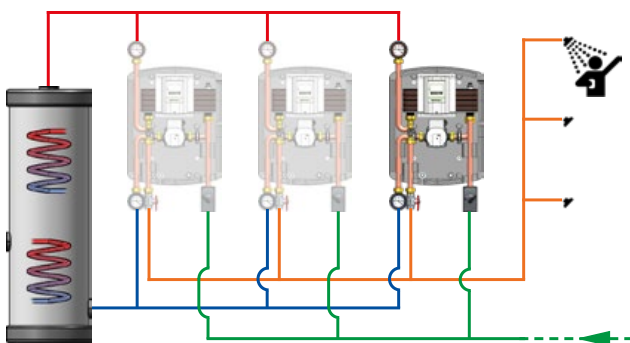

Operation in combination with medium-temperature heat sources (heat pumps)

For these systems there is a sizing and configuration procedure based on the project data provided by the Customer, which generally are different from one plant to another for temperature and storage volume, flow rates and required temperature in use.

The product is then delivered customized, based on the technical features of the specific plant.

Custom configuration tailored to the customer

The customization procedure uses a **"Kascata plant booklet"**, available in Excel format via the QR code or in the technical data sheet of the Kascata product on the institutional website www.brv.it.

ModvFresh Kascata - 2020

Sizing calculation for heat pump applications

Input data – By the Customer		
Max temperature of the buffer tank Max water temperature at which the heat source can load the buffer tank uniformly.	55	[°C]
Inlet cold water temperature Cold water temperature from the mains.	10	[°C]
Required temperature Hot water temperature to user.	45	[°C]
Required flow rate Constant flow rate to user.	60	[l/min]
Buffer tank capacity Volume of water contained in the buffer tank.	2500	[L]
Power of the heat pump Nominal thermal power at working temperature.	12	[kW]
Input data – By BRV Technical Department		
Min requested temperature of the buffer tank Min usable water temperature of the buffer tank	48	[°C]
DF Station+ (default: 70%)	70%	
DF Station- (default 20%)	20%	
Number of ModvFresh modules needed to compose the Kascata system (min.2 - max. 7)	4	
Data of calculated performances		
Supplied power Total power supplied by Kascata System	146,2	[kW]
Supply time Supply time at requested flow rate and temperature	9,1	[min]
Overall draw-off Overall volume of DHW supplied.	547,8	[L]
Time for restarting Required time to go from min to max buffer tank temperature.	102	[min]

The Customer fills in the first section of the document, with blue cells, reporting the data of the plant design and subsequently forwards the document to BRV.

BRV technical office will evaluate, based on the provided data, the optimal configuration (*), reporting the technical data and the number of ModvFresh 4 modules necessary to obtain required performances.

Thanks to the previously entered data, final performances of the system are automatically calculated and displayed for a checking by the designer.

(*) By working on the threshold values, reducing them for example in the case of use with heat pumps, whose supply temperatures are notoriously of medium-value, it is possible to obtain the maximum return of the system by maximizing the heat exchange of each heat exchanger fitted in the hydraulic modules. It is thus possible to reach acceptable DHW temperature values in use even with medium-temperature heat sources, such as heat pumps.

VFS range:	40 L/min	4.7.2 DF Station+ 70%	→	28 L/min
Max. flow:	160 L/min	4.7.3 DF Station- 20%	→	8 L/min
Module n.	Total flow rate		Total flow rate	
1	Up to	28 L/min		
2	On	28 L/min	Off	16 L/min
3	On	56 L/min	Off	24 L/min
4	On	84 L/min	Off	32 L/min

Once confirmed, the chosen parameters are set at the factory and the product will be delivered pre-set to the Customer, in addition to the "Kascata system booklet".

Codes and components - Kascata system without recirculation line

Components list	Quantity				
	200 kW 80 L/min	300 kW 120 L/min	400 kW 160 L/min	500 kW 200 L/min	600 kW 240 L/min
ModvFresh 4 modules (pre-wired)	2 pcs	3 pcs	4 pcs	5 pcs	6 pcs
ModvFresh 4 module with recirculation line (pre-wired)	-	-	-	-	-
Motorized zone valve	2 pcs	3 pcs	4 pcs	5 pcs	6 pcs
Flow rate limitation fitting	2 pcs	3 pcs	4 pcs	5 pcs	6 pcs
CAN-Bus connection box	1 pc	1 pc	1 pc	2 pc	2 pc
Complete system code, without recirculation line	MFK-200	MFK-300	MFK-400	MFK-500	MFK-600

Codes and components - Kascata system with recirculation line

Components list	Quantity				
	200 kW 80 L/min	300 kW 120 L/min	400 kW 160 L/min	500 kW 200 L/min	600 kW 240 L/min
ModvFresh 4 modules (pre-wired)	1 pc	2 pcs	3 pcs	4 pcs	5 pcs
ModvFresh 4 module with recirculation line (pre-wired)	1 pc	1 pc	1 pc	1 pc	1 pc
Motorized zone valve	2 pcs	3 pcs	4 pcs	5 pcs	6 pcs
Flow rate limitation fitting	2 pcs	3 pcs	4 pcs	5 pcs	6 pcs
CAN-Bus connection box	1 pc	1 pc	1 pc	2 pcs	2 pcs
Complete system code, with recirculation line	MFK-R-200	MFK-R-300	MFK-R-400	MFK-R-500	MFK-R-600



The images show ModvFresh 4 units with the optional ball valve kit installed (it can be ordered separately). The installation of this valve kit is recommended in order to carry out maintenance of the various groups if necessary.

Code 3/4": **031000SET**

DomvS Circ 1

DOMESTIC HOT WATER (DHW) RECIRCULATION KIT FOR COMBINED STORAGE TANK

The kit allows to make easily the connections for the DHW recirculation line to a combined storage tank with coil for DHW. The pre-assembled kit, by means of the corrugated steel pipe, creates a counter-current circulation that heats the water along the recirculation line.

Two models are available

- Kvs 2.5 for small-sized users.
- Kvs 4.0 for medium-sized users.

Features

- Anti scald thermostatic mixing valve.
- Adjustable control of the temperature to the user by means of a knob from 35°C up to 60°C.
- Check valve built into the inlet fitting of cold water.
- High efficiency circulating pump for the recirculation line with temperature sensor to limit its operation, keeping the water in the pipeline at the desired temperature. The pump switches off automatically when the water temperature reaches the value set on the motor body (between 20 and 70°C).
- High efficiency circulating pump (in the model that include it) equipped with temperature sensor and timer for a better energy saving.

Technical features

- Maximum static pressure 10 bar (PN 10); dynamic 5 bar.
- Maximum ratio between pressures: 2:1.
- Maximum inlet temperature of the thermostatic mixer: 95°C.
- Calibration temperature range: 35-60°C.
- Accuracy: ±2°C (Kvs 4.0); ±1°C (Kvs 2.5).

Connections

- 3/4" Union Male
- 1" Male to the buffer tank
- 1/2" Male to the recirculation

Recirculation operation

When the circulating pump is activated, the cold water present in the recirculation ring, passing through the flexible pipe, returns heated towards the H port of the thermostatic mixer; the door C of the mixer is normally closed until the temperature of the recirculation ring approaches the one set on the mixing valve (a condition which is unlikely to occur). Circulation in the recirculation loop remains active until the pump sensor or the timer are satisfied.

[mH₂O]

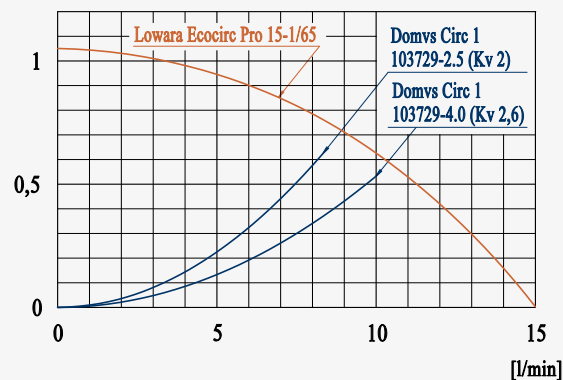

Lowara Ecocirc Pro 15-1/65 circulating pump. The headloss of the DomvS Circ 1 kit is measured between the points **A** and **B** of the hydraulic scheme.



Code: **103729-(2.5/4.0)**

With circulating pump: **103729-(2.5/4.0)-(R/RU)**

PED 2014/68/EU 4.3



Available Kvs:

2.5 = Maximum Kvs 2.7;
up to 55 L/min (1.5 bar).

4.0 = Maximum Kvs 4.0;
up to 82 L/min (1.5 bar).



Available circulating pumps:

With temperature sensor **(R)**

With temperature sensor and timer **(RU)**



Hydraulic scheme

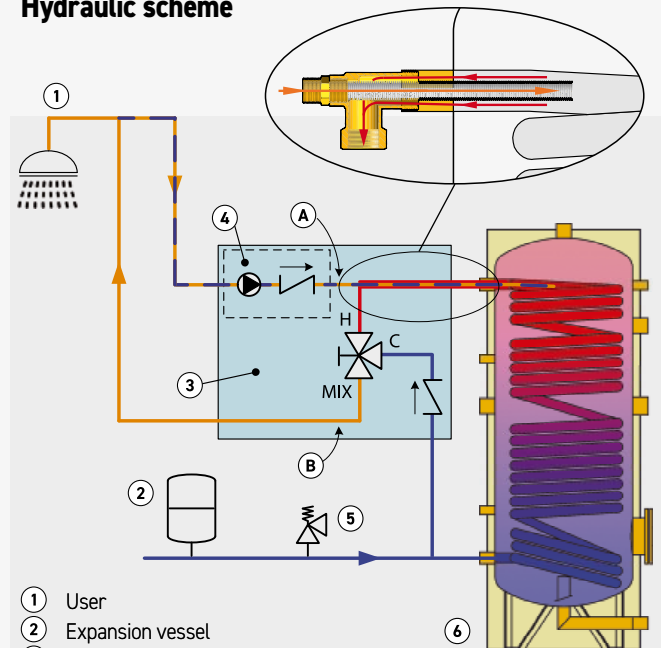

- ① User
- ② Expansion vessel
- ③ DomvS Circ 1
- ④ Circulating pump and check valve (included only in the models R and RU)
- ⑤ Safety valve
- ⑥ Combined storage tank
- Ⓐ Ⓑ Measuring points to determine the headlosses

DomvS Circ 2 RECIRCULATION KIT FOR DOMESTIC HOT WATER TANK

The kit allows make easily the connections between the DHW circulation system and a domestic hot water tank. The pre-assembled and insulated kit, by means of an anti-scald thermostatic mixer, allows the user to set hot water temperature from 35 to 60°C. The temperature of the recirculation line is adjusted independently by a dedicated thermostat integrated in the high-efficiency circulating pump, while a special metal back plate facilitates installation both on the wall and on hot water tank. Suitable for medium-sized users up to 82 L/min. (1.5 bar).

Features

- Anti scald thermostatic mixing valve.
- Control of user temperature adjustable by means of a knob from 35°C up to 60°C.
- The check valves and the isolating valves in the kit do not require the installation of any other hydraulic control component.
- Thermometers with scale 0÷120°C display the temperature of the hot water in the tank, mixed water for user and recirculation line.
- High efficiency circulating pump for the recirculation line with temperature sensor to restrict the working time, keeping the water into the piping at the required temperature. The pump automatically stops when the water temperature reaches the set value on the body of the motor (between 20 and 70°C).
- Version with circulating pump equipped with thermostat and timer for a better energy saving.
- Back plate to fit the kit to the wall or to the water tank.

Technical features

- Maximum static pressure 10 bar (PN10); dynamic 5 bar.
- Maximum ratio between pressures 2:1.
- Maximum inlet temperature of the thermostatic mixing valve: 95°C.
- User setting temperature range: 35÷60°C.
- Accuracy: ±2°C.

Connections:

- 3/4" Female.

Hydraulic scheme

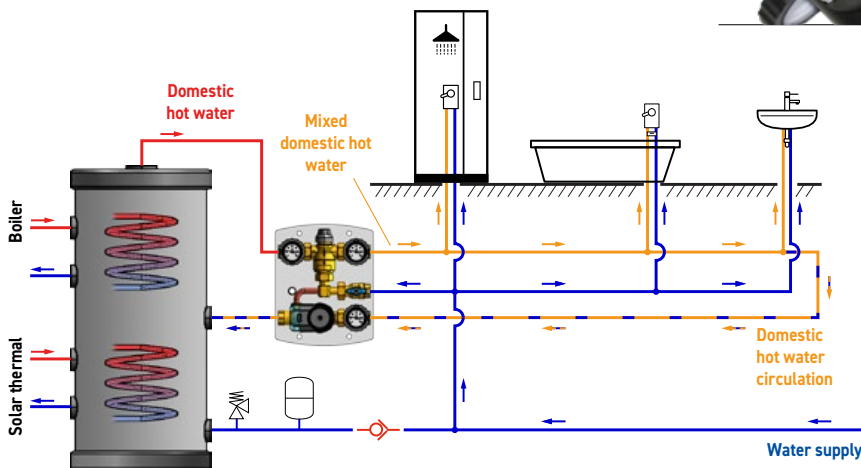

Code: 203726-4.0-(R/RU)

PED 2014/68/EU 4.3



Available Kvs:
4.0 = Maximum Kvs 4.0;
up to 82 L/min (1.5 bar).



Available circulating pumps:
With temperature sensor **(R)**
With temperature sensor
and timer **(RU)**

Thermostatic mixing valve: test carried out at our laboratory at a differential pressure of 1 bar
Kvs 4.0: Th:65°C Tc:15°C Tmix:51°C (knob in position 3) → 65 L/min



Particular of the circulating pump provided with thermostat and timer.

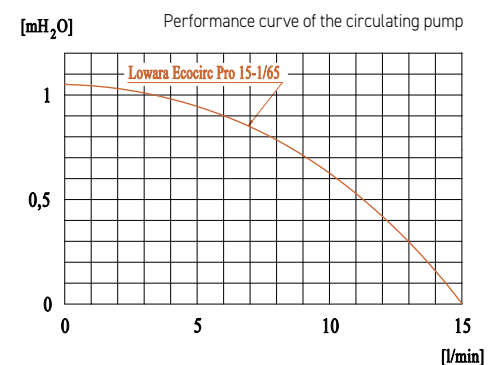

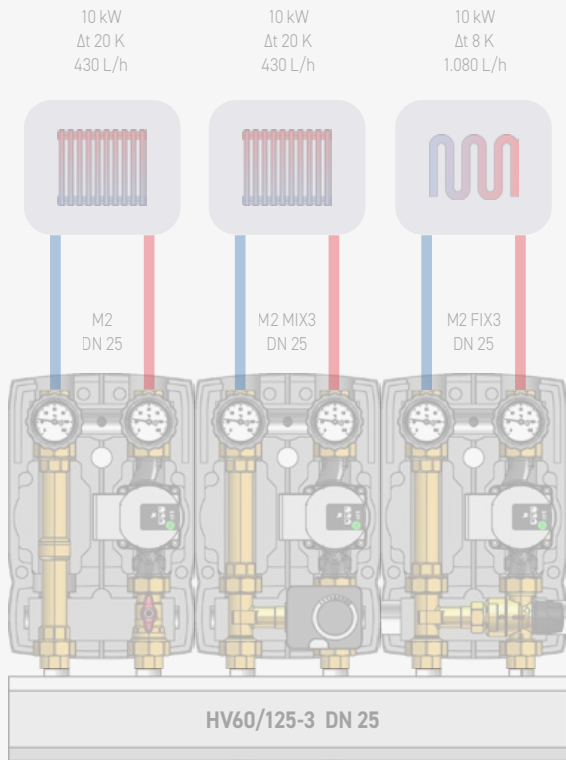

Modular systems for energy management

Heat source

- Solid fuel boiler.

Buffer tank loading by the boiler

- **Version 1:**
 use of anti-condensation pump unit **MCCS DN25**; Δt 20 K;
- **Version 2:**
 use of anti-condensation recirculation pump unit **M2 FIX3 CS DN25**; Δt 20 K;

Distribution

- Heating zone manifold **HV 60/125 DN25** for 3 pump units.

Example of heating users

- Low power radiator circuit, Δt 20 K:
 unmixed pump unit **M2 DN25**;
- Low power radiator circuit, Δt 20 K:
 mixed pump unit **M2 MIX3 DN25**;
- Low power underfloor heating circuit, Δt 8 K:
 fixed temperature pump unit **M2 FIX3 DN25**.

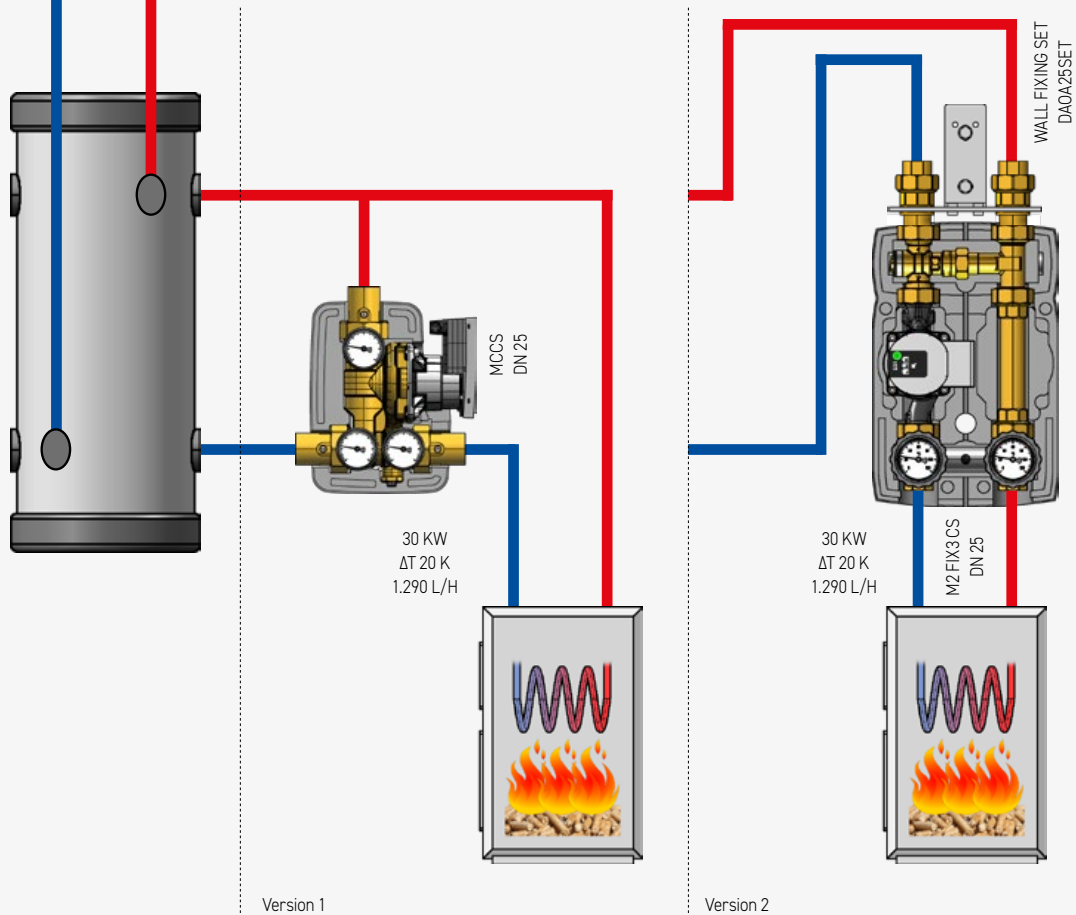

Note: the representations are to be considered just as an indication and they have no completeness pretension.

ANTI-CONDENSATION PUMP UNITS DN20 WITH RECIRCULATION THERMIC VALVE

M2 FIX3 CS

2-WAY PUMP UNIT WITH RECIRCULATION THERMIC VALVE FOR SOLID FUEL BOILERS

The unit for 1/2" (130 mm) circulating pumps consists of:

Supply

- Flanged ball valve with 20 mbar check valve (which can be excluded by rotating the handle by 45°) supplied with in-handle thermometer (red ring; 0°C-120°C).
- "T" connection for thermic valve.
- Connection.

Return

- Connection.
- Recirculation thermic valve with the sensor dipped into the fluid. Start opening temperature: 60°C (F3), 45°C (F4) and 55°C (F5).
- High efficiency synchronous pre-wired circulating pump (for the models that include it).
- Flanged ball valve supplied with in-handle thermometer (blue ring, range 0°C-120°C).

Centre distance 90 mm.

EPP insulation box (Dimensions: 180x302x142 mm).

PN 10, max temperature 100°C (unit without pump).

Connections: 3/4" Female to the heat source.

3/4" Male with swivel shank to the user.

FIELD OF USE

For power up to 28 kW (with Δt 20 K) and maximum flow rate 1200 l/h.
Kvs Value: 2.8.

Approximate data calculated with a 6 m head circulating pump. For an accurate sizing or for higher flow rates, please refer to the curves shown in the technical section.

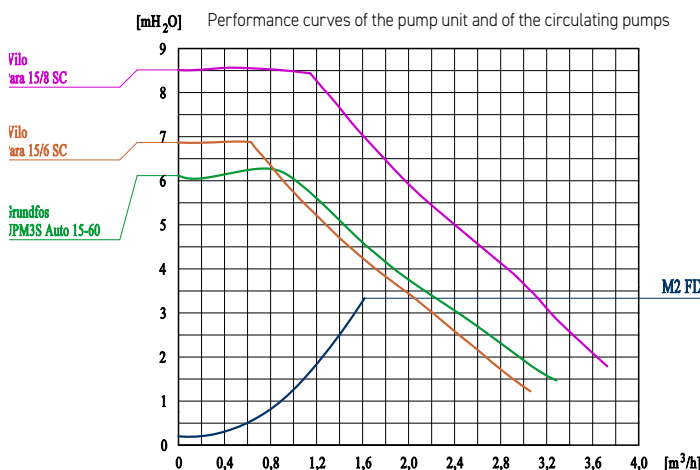

It is recommended to install two isolating valves **Art. 552** (see the section "Zone manifolds") after the pump unit to allow an easy service or replacement of the components of the unit.

Code: **03552/M**



Code: **20255R-F(3/4/5)CS**

With circulating pump:

20255R-F(3/4/5)CS-(P6/A6/P8)



Available circulating pumps:

Wilo Para 15/6 SC **(P6)**

Grundfos UPM3S Auto 15-60 **(A6)**

Wilo Para 15/8 SC **(P8)**



Available thermostatic mixing valves:

Start opening temperature 60°C **(F3)**

Start opening temperature 45°C **(F4)**

Start opening temperature 55°C **(F5)**



Buffer tank / heating system



Solid fuel boiler

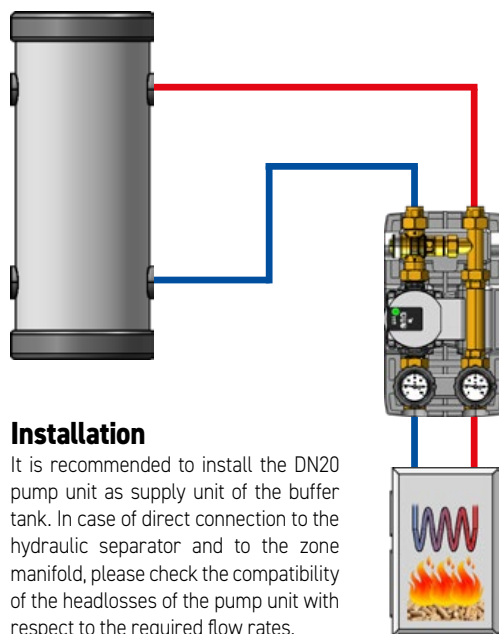

Installation

It is recommended to install the DN20 pump unit as supply unit of the buffer tank. In case of direct connection to the hydraulic separator and to the zone manifold, please check the compatibility of the headlosses of the pump unit with respect to the required flow rates.

Standard version: right supply. Left supply version available with extra price: look at price list.

ANTI-CONDENSATION DN25 PUMP UNITS WITH RECIRCULATION THERMIC VALVE

Pump units for solid fuel boilers (wood, pellets, etc.) allow the connection of the heating system or of the buffer tank to the heat source. By means of a 3-way recirculation thermic valve (M2 FIX3 CS), or by means of a 3-way mixing valve managed by an actuator with electronic control (M2 MIX3 CS), the return temperature is kept constantly above the condensation temperature, avoiding the formation of sediments, both in the boiler and in the chimney flue, so improving the efficiency and life.



M2 FIX3 CS

M2 MIX3 CS

M2 FIX3 CS

2 WAY PUMP UNIT WITH RECIRCULATION THERMIC VALVE FOR MEDIUM POWER SOLID FUEL BOILERS

The unit for 1" (180 mm) circulating pumps consists of:

Supply

- Flanged ball valve with 20 mbar check valve (which can be excluded by rotating the handle by 45°) supplied with in-handle thermometer (red ring; 0°C-120°C).
- "T" connection for thermic valve.
- Connection.

Return

- Connection.
- Recirculation thermic valve with the sensor dipped into the fluid. Start opening temperature: 60°C (F3), 45°C (F4) and 55°C (F5).
- High efficiency synchronous pre-wired circulating pump (for the models that include it).
- Flanged ball valve supplied with in-handle thermometer (blue ring, range 0°C-120°C).

Centre distance 125 mm.

EPP insulation box (Dimensions: 250x380x170 mm).

PN 10, max temperature 100°C (unit without pump).

External connections: 1" Female.



Code 1": 20355R-F(3/4/5)CS

With circulating pump:

20355R-F(3/4/5)CS-(P6/A6/P8)



Available circulating pumps:

Wilo Para 25/6 SC (P6)

Grundfos UPM3S Auto 25-60 (A6)

Wilo Para 25/8 SC (P8)



Available thermostatic mixing valves:

Start opening temperature 60°C (F3)

Start opening temperature 45°C (F4)

Start opening temperature 55°C (F5)



Buffer tank / heating system



Solid fuel boiler

FIELD OF USE

For power up to 32 kW (with Δt 20 K) and maximum flow rate 1400 l/h.

Kvs Value: 3.0.

Approximate data calculated with a 6 m head circulating pump. For an accurate sizing or for higher flow rates, please refer to the curves shown in the technical section.

Operation of the recirculation thermic valve

(e.g. model F5 - 55°C)

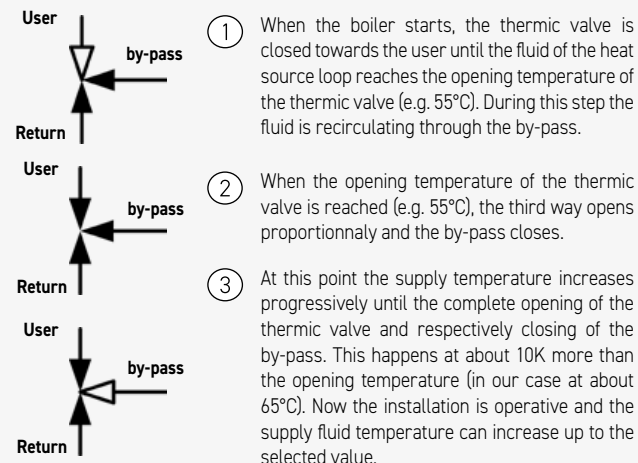

Standard version: right supply. Left supply version available with extra price: look at price list.

It is recommended to install two isolating valves Art. 552 with nut and gasket (see the section "DN25 Zone manifolds") after the pump unit to allow an easy service or replacement of the components of the unit.



Code 1": 0266/M

ANTI-CONDENSATION DN25 PUMP UNITS WITH MIXING VALVE AND ACTUATOR

M2 MIX3 CS

2-WAY PUMP UNIT FOR HIGH POWER SOLID FUEL BOILERS WITH ELECTRONIC ACTUATOR FOR THE CONTROL OF THE RETURN TEMPERATURE

The unit for 1" (180 mm) circulating pumps consists of:

Supply

- Flanged ball valve with 20 mbar check valve (which can be excluded by rotating the handle by 45°) supplied with in-handle thermometer (red ring; 0°C-120°C).
- "T" connection for mixing valve and swivel nut.
- Connection.

Return

- Connection.
- 3-way mixing valve with electronic actuator.
- High efficiency synchronous pre-wired circulating pump (for the models that include it).
- Flanged ball valve supplied with in-handle thermometer (blue ring, range 0°C-120°C).
- Temperature sensor.

Centre distance 125 mm.

EPP insulation box (Dimensions: 250x380x170 mm).

PN 10, max temperature 110°C (unit without pump).

External connections: 1" Female.

FIELD OF USE

For power up to 50 kW (with Δt 20 K) and maximum flow rate 2150 l/h. Kvs Value: 6.0.

Approximate data calculated with a 6 m head circulating pump. For an accurate sizing or for higher flow rates, please refer to the curves shown in the technical section.



The electronics of the actuator keeps constant the set temperature of the return way, monitoring it by means of a sensor (included) mounted on the pipe. Display of the measured temperature and target temperature, on reversible LCD display.

Setting of target temperature adjustable from 10°C up to 95°C. Operating range of 90°. Power supply 230V, torque 6 Nm. IP42.



It is recommended to install two isolating valves **Art. 552 with nut and gasket** (see the section "DN25 Zone manifolds") after the pump unit to allow an easy service or replacement of the components of the unit.

Code 1": **0266/M**



Code 1": **20355R-M3C-CT**

With circulating pump: **20355R-M3C-(P6/A6/P8)-CT**

Code 1": **20355R-M3C-M21**

With circulating pump: **20355R-M3C-(P6/A6/P8)M21**



Available circulating pumps:

Wilo Para 25/6 SC (P6)

Grundfos UPM3S Auto 25-60 (A6)

Wilo Para 25/8 SC (P8)



Buffer tank / heating system



A version with 3 point actuator is also available (code with final part ...M21).

In this case an electronic external controller is required.

Performance curves of the pump unit and of the circulating pumps

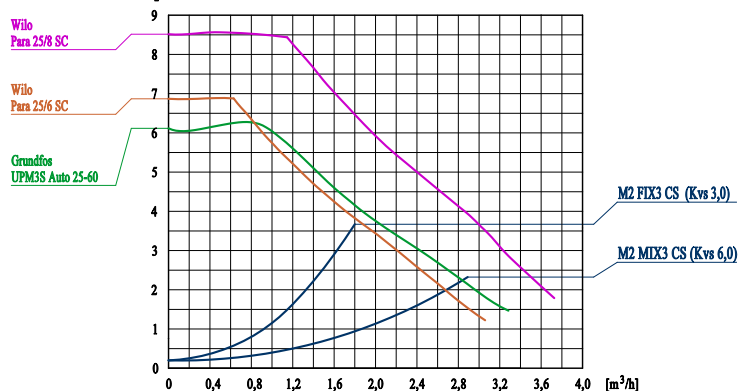

Standard version: right supply. Left supply version available with extra price: look at price list.

M2 Exchange HEAT EXCHANGE UNIT

Heat exchange unit for hydraulic installations with insulation box, made of hot forged brass. By means of this unit it is possible to divide hydraulically the primary circuit fed by a wood, pellet boiler etc. from the secondary circuit (e.g. underfloor heating system) in systems where it is not allowed to use the same vector fluid in all the circuit.

Asymmetric weld-braided plate heat exchanger made of stainless steel AISI 316. Designed for direct connection to the anti-condensation pump unit of the primary circuit and to the mixed pump unit of the secondary circuit by means of 1" Male connections. It is also possible to connect several fittings to the "T" connectors.

A 3 bar safety unit with a $\varnothing 50$ mm (0-4 bar) pressure gauge and a draining valve are included in the "heating" circuit (secondary).

Centre distance 125 mm.

EPP insulation box (Dimensions: 250x143x218).

50 kW safety valve.

PN 10. Constant temperature 100°C.

External connections: 1" Male.



Code: see below table



CE

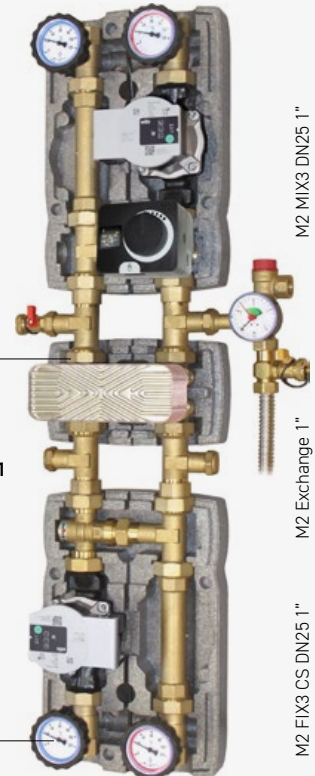

Standard scheme

- S1:** External temperature sensor.
- S2:** Supply temperature sensor.
- S5:** Ambient temperature sensor RCD20 (option).
- R1:** Mixed high efficiency circulating pump (secondary).
- M:** 3-way motorized mixing valve of the mixed circuit (secondary) with built-in climatic controller.
- F:** Thermic valve of the boiler circuit (primary).
- R2:** Boiler circuit high efficiency circulating pump (primary).
- E:** Asymmetric plate heat exchanger.

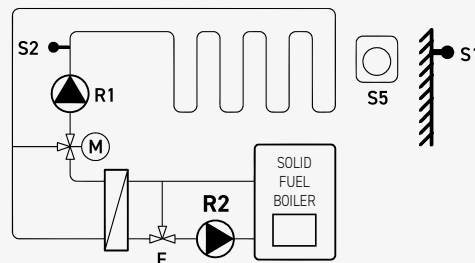

Standard installation controlled by AHD20 climatic controller

Field of use

For power up to:	12 kW	16 kW	20 kW	30 kW
Boiler side flow rate (max.):	1.030 l/h	1.370 l/h	1.720 l/h	2.570 l/h
Boiler side head loss (primary) * :	2,5 mH ₂ O	2,5 mH ₂ O	2,2 mH ₂ O	2,1 mH ₂ O
Secondary side flow rate:	980 l/h	1.260 l/h	1.480 l/h	2.050 l/h
Secondary side head loss * :	0,8 mH ₂ O	0,9 mH ₂ O	0,8 mH ₂ O	0,8 mH ₂ O
Code:	203646-12KW	203646-16KW	203646-20KW	203646-30KW

* : Head loss of the heat exchanger alone at the maximum flow rate, with reference to the corresponding loop.

Note: These data must be considered just as an indication. They are based on a DT of 10 K between the supply and the return (in both circuits) and on the average performances of the circulating pumps. The data must be checked taking into consideration the specifications of the installation that is to be carried out.

ANTI-CONDENSATION DN32 PUMP UNITS WITH RECIRCULATION THERMIC VALVE

M2 FIX3 CS

2 WAY PUMP UNIT WITH RECIRCULATION THERMIC VALVE FOR SOLID FUEL BOILERS

The unit for 1 1/4 (180 mm) circulating pumps consists of:

Supply

- Flanged ball valve supplied with in-handle thermometer (red ring; 0°C-120°C).
- Connection with 20 mbar check valve.
- "T" Connection for thermic valve.
- Connection.

Return

- Connection.
- Recirculation thermic valve with the sensor dipped into the fluid.
Start opening temperature: 60°C (F3), 45°C (F4) and 55°C (F5).
- High efficiency synchronous pre-wired circulating pump (for the models that include it).
- Flanged ball valve supplied with in-handle thermometer (blue ring, range 0°C-120°C).

Centre distance 125 mm.

EPP insulation box (Dimensions: 250x400x170 mm).

PN 10, max temperature 100°C (unit without pump).

External connections: 1 1/4 Female.

FIELD OF USE

For power up to 93 kW (with Δt 20 K) and maximum flow rate 4000 l/h.
Kvs Value: 7.0.

Approximate data calculated with a 8 m head circulating pump (Wilo Para Maxo 30-180-08). For an accurate sizing or for higher flow rates, please refer to the curve.



Installation

The DN32 anti-condensation pump unit, thanks to the generous dimensions of the thermic valve, can feed directly the distribution unit (hydraulic separator and zone manifold) without having to pass through the buffer tank. In fact the very low headlosses of the pump unit guarantee a high flow rate in the primary circuit up to 4000 l/h.



Code 1 1/4: **20555R-F(3/4/5)CS**
With circulating pump:
20555R-F(3/4/5)CS-(A6/P7/P8)



Available circulating pumps:

Grundfos Alpha 1 32-60 (A6)
Wilo Para 30/8 SC (P7)
Wilo Para Maxo 30-180-08 (P8)



Available thermostatic mixing valves:

Start opening temperature 60°C (F3)
Start opening temperature 45°C (F4)
Start opening temperature 55°C (F5)

CE



BIOMASS

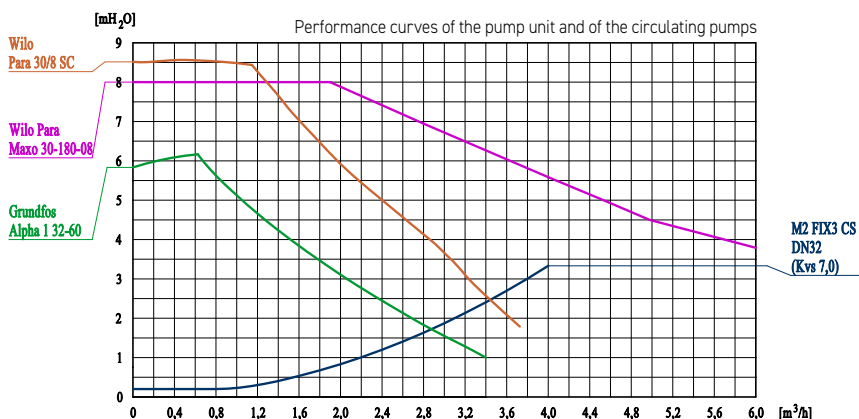

Standard version: right supply. Left supply version available with extra price: look at price list.

It is recommended to install two isolating valves **Art. 552** (see the section "DN25 Zone manifolds") with nut and gasket before the pump unit to allow an easy service or replacement of the components of the unit.

Code 1 1/4: **05552/M**



ANTI-CONDENSATION DN32 PUMP UNITS WITH MIXING VALVE AND ACTUATOR

M2 MIX3 CS

2-WAY PUMP UNIT FOR SOLID FUEL BOILERS WITH ELECTRONIC ACTUATOR FOR THE CONTROL OF THE RETURN TEMPERATURE

The unit for 1 1/4 (180 mm) circulating pumps consists of:

Supply

- Flanged ball valve supplied with in-handle thermometer (red ring; 0°C-120°C).
- Connection with 20 mbar check valve.
- "T" Connection for mixing valve.
- Connection.

Return

- Connection.
- 3-way mixing valve with electronic actuator.
- High efficiency synchronous pre-wired circulating pump (for the models that include it).
- Flanged ball valve supplied with in-handle thermometer (blue ring, range 0°C-120°C).
- Temperature sensor.

Centre distance 125 mm.

EPP insulation box (Dimensions: 250x400x170 mm).

PN 10, max temperature 110°C (unit without pump).

External connections: 1 1/4 Female.

FIELD OF USE

For power up to 111 kW (with Dt 20 K) and maximum flow rate 4800 l/h.
Kvs Value: 13.0.

Approximate data calculated with a 8 m head circulating pump (Wilo Para Maxo 30-180-08). For an accurate sizing or for higher flow rates, please refer to the curve.



The electronics of the actuator keeps constant the set temperature of the return way, monitoring it by means of a sensor (included) mounted on the pipe. Display of the measured temperature and target temperature, on reversible LCD display.



Setting of target temperature adjustable from 10°C up to 95°C. Operating range of 90°. Power supply 230V, torque 6 Nm. IP42.



Code 1 1/4: **20555R-M3C-CT**

With circulating pump: **20555R-M3C-(A6/P7/P8)-CT**

Code 1 1/4: **20555R-M3C-M21**

With circulating pump: **20555R-M3C-(A6/P7/P8)M21**



Available circulating pumps:

Grundfos Alpha 1 32-60 **(A6)**

Wilo Para 30/8 SC **(P7)**

Wilo Para Maxo 30-180-08 **(P8)**



Buffer tank / heating system



Solid fuel boiler

A version with 3 point actuator is also available (code with final part ...M21).

In this case an electronic external controller is required.

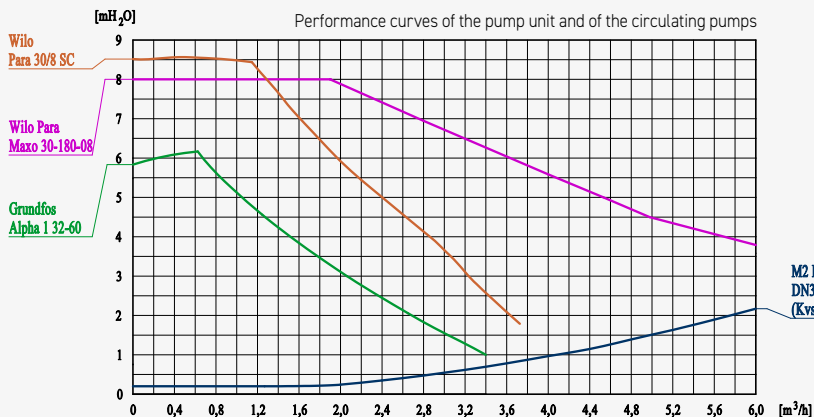

Standard version: right supply. Left supply version available with extra price: look at price list.

It is recommended to install two isolating valves **Art. 552** (see the section "DN32 Zone manifolds") with nut and gasket before the pump unit to allow an easy service or replacement of the components of the unit.

Code 1 1/4: **05552/M**



Art. 749

**ANTI-CONDENSATION VALVE
WITH THERMOSTATIC CONTROL**

Function

The anti-condensation thermic valve optimizes the connection of the solid fuel heating source to the heating system, or to the puffer, automatically adjusting the temperature of the water returning to the generator to the calibration value of the chosen thermostat.

The device keeps the heat generator at a high temperature (always above that of condensation) in any condition of use, avoiding the formation of sediments both in the boiler and in the chimney flue, thus improving its efficiency and life. Corrosion of the heat generator or dangerous chimney flue fires are therefore avoided.

Technical features

Anti-condensation thermic valve with thermostatic control of the return temperature to solid fuel heating sources.

Hot forged brass body with pipe union connections. Yellow brass finish.

- Maximum working pressure: 10 bar.
- Maximum temperature: 100°C.
- Calibration temperatures: 45°C, 55°C and 60°C; (70°C and 80°C on demand).
- Seal: watertight between the A-AB ports; 3% leak rate of Kvs between B-AB ports.
- Easy service or replacement of the sensor to change the calibration without removing the valve from the installation.

PN 10. A-AB kvs value: 3.5. B-AB kvs value: 2.3.

Nominal opening temperature: calibration temperature + 10 K.

Available external connections: 3/4" Male pipe union

Installation

The valve can be installed on both sides of the heating source, in vertical or horizontal position:

- On the return pipe to the boiler (calibration at 45°C, 55°C or 60°C), in mixing mode;
- On the supply pipe to the buffer tank (calibration at 70°C or 80°C), in diverting mode with system control function.

To optimize the anti-condensation control, it is recommended to install the device on the return to the boiler (scheme 1).

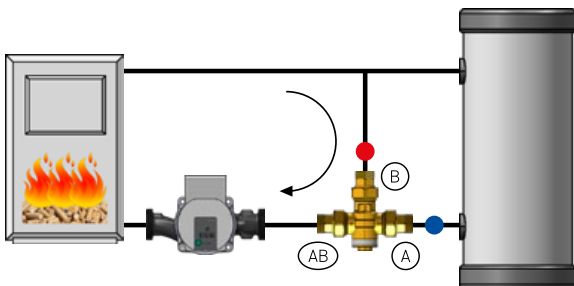

Scheme 1

Mixing mode installation with anti-condensation function.

Max. Δp: 100 kPa



Code 3/4": **03749-xx**

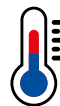

Available calibration temperatures:

- 45 = 45 °C
- 55 = 55 °C
- 60 = 60 °C
- 70 = 70 °C



Calibration temperatures available on demand:
80 = 80 °C

PED 2014/68/EU 4.3



FIELD OF USE

For a maximum power that can be managed up to 32 kW (with Δt 20 K) and maximum flow rate 1400 l/h.

BIOMASS

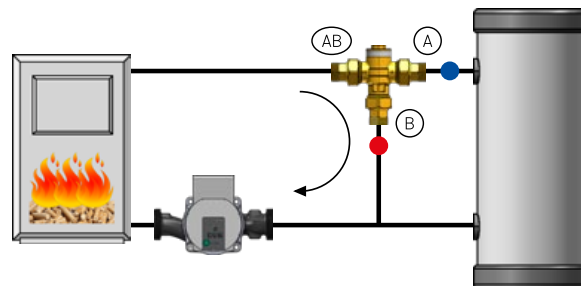

Scheme 2

Diverting mode installation with system control function.

Max. Δp: 30 kPa

Code composition: the suffix "xx" shows the setting temperature of the thermic valve; e.g.: **03749-55** (calibration at 55°C)

Operating principle

The hydraulic schemes shown below refer to the use of the thermic valve in mixing mode that, as mentioned, allows the optimization of anti-condensation control.

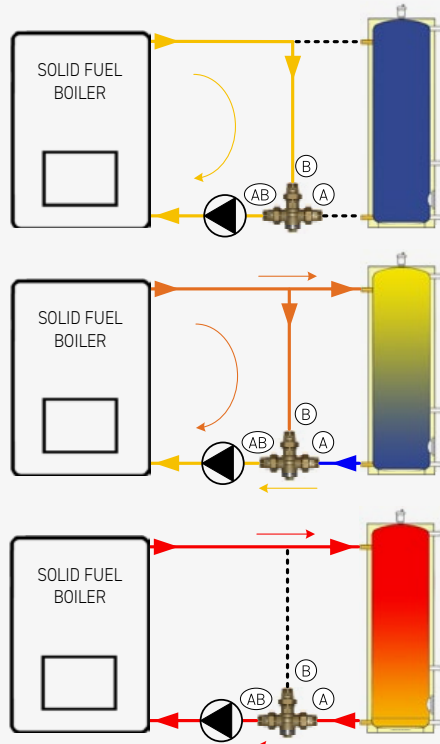

- ① **Start-up of the system (boiler heating)**
When the boiler is switched on, the thermic valve is completely closed towards the user (**port A**) and this condition remains until the fluid, heated by the heat generator, reaches the opening temperature of the thermic valve (corresponding to that of calibration, for example 55°C). During this phase, the fluid delivered by the boiler recirculates internally towards the by-pass (**port B**) and the boiler temperature rises quickly.
- ② **Loading the system (heating the buffer tank)**
When the opening temperature is reached (e.g. 55°C), the way to the users (**port A**) is proportionally opened while, at the same time, the by-pass (**port B**) is closed. The boiler temperature rises slowly, giving energy to the user, but in any case the return temperature will no longer fall below the calibration one (e.g. 55°C)
- ③ **Fully operational system**
Starting from the condition reported in point 2, the flow temperature increases progressively until the thermic valve is completely opened (**port A**) and the relative closing of the by-pass (**port B**). This occurs at about 10 K higher than the opening or calibration temperature (therefore in the example at about 65°C). At this point the system is in operation and the delivery fluid temperature can rise up to the set value.

! **Note:** the following representations are to be considered just as an indication and they have no completeness pretension.

Art. 746

Anti-condensation thermic valve with thermostatic control of the return temperature to solid fuel boilers.
Hot forged brass body. Yellow brass finish.
External connection: 1" Male flat seal.
Technical features and calibration temperatures remain the same as those listed for the art. 749.

Code: **04746-xx**

PED 2014/68/EU 4.3



Art. 740

Anti-condensation thermic valve with thermostatic control of the return temperature to solid fuel boilers.
Hot forged brass body. Yellow brass finish.
External connection: 3/4" Female.
Technical features and calibration temperatures remain the same as those listed for the art. 749.

Code: **03740-xx**

PED 2014/68/EU 4.3



Art. 741C

Anti-condensation thermic valve with thermostatic control of the return temperature to solid fuel boilers.
Hot forged brass body. Yellow brass finish.
Outlet on AB swivel nut 1" or 1 1/2" port (see picture at side) to be connected directly to the circulating pump.
External connection: 1" Swivel nut x 1" Male and 1 1/2 Swivel nut x 1" Male.
Technical features and calibration temperatures remain the same as those listed for the art. 749.

Code 1" C x 1" M: **04741C-04-xx**

Code 1 1/2 C x 1" M: **04741C-06-xx**

PED 2014/68/EU 4.3



Code composition: the suffix "xx" shows the setting temperature of the thermic valve; e.g.: **04741C-04-60** (calibration at 60°C)

Art. 749S

ANTI-CONDENSATION VALVE WITH THERMOSTATIC CONTROL

Function

The anti-condensation thermic valve optimizes the connection of the solid fuel heating source to the heating system, or to the puffer, automatically adjusting the temperature of the water returning to the generator to the calibration value of the chosen thermostat.

The device keeps the heat generator at a high temperature (always above that of condensation) in any condition of use, avoiding the formation of sediments both in the boiler and in the chimney flue, thus improving its efficiency and life. Corrosion of the heat generator or dangerous chimney flue fires are therefore avoided.

Technical features

Anti-condensation thermic valve with thermostatic control of the return temperature to solid fuel heating sources. Hot forged brass body with pipe union connections. Yellow brass finish.

- Maximum working pressure: 10 bar.
- Maximum temperature: 100°C.
- Calibration temperatures: 45°C, 55°C, 60°C and 72°C.
- Leak rate: A-AB max. 1% of Kvs value; B-AB max. 3% of Kvs value.
- High Kvs value.

PN 10. A-AB kvs value: 6.5. B-AB kvs value: 6.5.

Nominal opening temperature: calibration temperature + 10 K.

Available external connections: 3/4" Male pipe union.

Installation

The valve can be installed on both sides of the heating source, in vertical or horizontal position:

- On the return pipe to the boiler (calibration at 45°C, 55°C or 60°C), in mixing mode;
- On the supply pipe to the buffer tank (calibration at 70°C or 80°C), in diverting mode with system control function.

To optimize the anti-condensation control, it is recommended to install the device on the return to the boiler (scheme 1).

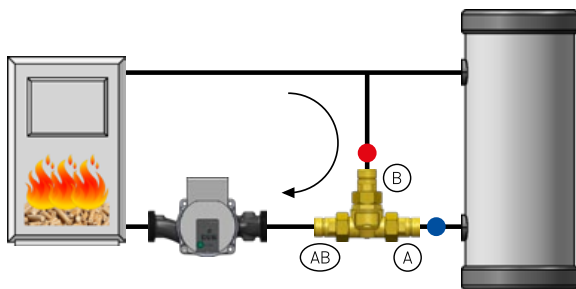

Scheme 1

Mixing mode installation with anti-condensation function.

Max. Δp: 100 kPa



Code 3/4": **03749S-xx**

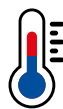

Available calibration temperatures:

45 = 45 °C

55 = 55 °C

60 = 60 °C

72 = 72 °C



PED 2014/68/EU 4.3

**New model
with higher
performances**



FIELD OF USE

For a maximum power that can be managed up to 60 kW (with Δt 20 K) and maximum flow rate 2600 l/h.

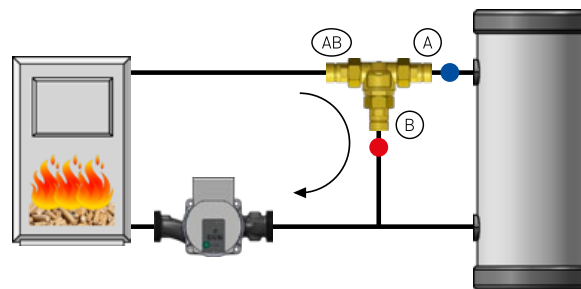

Scheme 2

Diverting mode installation with installation control function.

Max. Δp: 30 kPa

Art. 746 S

Anti-condensation thermic valve with thermostatic control of the return temperature to solid fuel boilers. Hot forged brass body. Yellow brass finish.

External connection: 1" Male flat seal.

Technical features and calibration temperatures remain the same as those listed for the art. 749S.

Code: **04746S-xx**

PED 2014/68/EU 4.3



Code composition: the suffix "xx" shows the setting temperature of the thermic valve; e.g.: **03749S-55** (calibration at 55°C)



Code 1": **04749-xx**

Art. 749

ANTI-CONDENSATION VALVE WITH THERMOSTATIC CONTROL

Function

The anti-condensation thermic valve optimizes the connection of the solid fuel heating source to the heating system, or to the puffer, automatically adjusting the temperature of the water returning to the generator to the calibration value of the chosen thermostat.

The device keeps the heat generator at a high temperature (always above that of condensation) in any condition of use, avoiding the formation of sediments both in the boiler and in the chimney flue, thus improving its efficiency and life. Corrosion of the heat generator or dangerous chimney flue fires are therefore avoided.

Technical features

Anti-condensation thermic valve with thermostatic control of the return temperature to solid fuel heating sources. Hot forged brass body with pipe union connections. Yellow brass finish.

- Maximum working pressure: 10 bar.
- Maximum temperature: 100°C.
- Calibration temperatures: 45°C, 55°C, 60°C and 72°C.
- Seal: watertight between the A-AB ports; 3% leak rate of Kvs between B-AB ports.
- Easy service or replacement of the sensor to change the calibration without removing the valve from the installation.

PN 10. A-AB kvs value: 7.2. B-AB kvs value: 4.8.

Nominal opening temperature: calibration temperature + 10 K.

Available external connections: 1" Male pipe union.

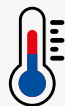

Available calibration temperatures:

45 = 45 °C

55 = 55 °C

60 = 60 °C

72 = 72 °C



PED 2014/68/EU 4.3



FIELD OF USE

For a maximum power that can be managed up to 65 kW (with Dt 20 K) and maximum flow rate 2800 l/h.

Art. 746

Anti-condensation thermic valve with thermostatic control of the return temperature to solid fuel boilers.

Hot forged brass body. Yellow brass finish.

External connection: 1"1/4 Male flat seal.

Technical features and calibration temperatures remain the same as those listed for the art. 749.

Code 1"1/4: **05746-xx**

PED 2014/68/EU 4.3



Art. 740

Anti-condensation thermic valve with thermostatic control of the return temperature to solid fuel boilers.

Hot forged brass body. Yellow brass finish.

External connection: 1" Female.

Technical features and calibration temperatures remain the same as those listed for the art. 749.

Code 1": **04740-xx**

PED 2014/68/EU 4.3



Art. 741C

Anti-condensation thermic valve with thermostatic control of the return temperature to solid fuel boilers.

Hot forged brass body. Yellow brass finish.

Outlet on AB swivel nut 1"1/4 (see picture at side) or 2" to be connected directly to the circulating pump.

External connection: 1"1/4 Swivel nut x 1"1/4 Male and 2" Swivel nut x 1"1/4 Male.

Technical features and calibration temperatures remain the same as those listed for the art. 749.

Code 1"1/4 Cal. x 1"1/4M: **05741C-05-xx**

Code 2" Cal. x 1"1/4M: **05741C-07-xx**

PED 2014/68/EU 4.3



Code composition: the suffix "xx" shows the setting temperature of the thermic valve; e.g.: **04749-55** (calibration at 55°C)

Art. 745

ANTI-CONDENSATION RECIRCULATION PUMP UNIT WITH THERMOSTATIC CONTROL

Function

The anti-condensation recirculation pump unit allows to connect directly the solid fuel heating source to the heating system or to the buffer tank without the aid of other devices. In fact, the unit encloses the circulating pump, the anti-condensation thermic valve, the excludable natural circulation clapet valve, isolating valves and thermometers in a compact and elegant insulation. It automatically adjusts the temperature of the water returning to the generator to the calibration value of the chosen thermostat.

The device keeps the heat generator at a high temperature (always above that of condensation) in any condition of use, avoiding the formation of sediments both in the boiler and in the chimney flue, thus improving its efficiency and life. Corrosion of the generator or dangerous flue chimney fires are therefore avoided.

Features

Anti-condensation recirculation and distribution pump unit with thermostatic control of the return temperature to solid fuel heating sources.

Cast brass body CB753S. Yellow brass execution.

- Synchronous high efficiency Wilo Para SC/8.
- Maximum working pressure: 10 bar.
- Maximum temperature: 100°C.
- Calibration temperature: 45°C, 55°C, 60°C and 72°C.
- Natural circulation clapet valve: with external control, it can be set on or off according to the type of installation.
- Temperature thermometers: 0-120°C.

Nominal opening temperature: calibration temperature + 10 K.

Available external connections: 1" and 1 1/4" female, 28 mm for copper pipe.

Installation

The anti-condensation recirculation pump unit can be placed on both sides of the heating source, following these directions:

- On the return pipe to the boiler in mixing mode, following the flow directions shown on the body.
- In vertical position (horizontal circulating pump axis) to allow the hydraulic working of the natural circulation clapet valve.

In order to optimize the anti-condensation control, it is recommended the installation of the unit on the return way to the boiler.

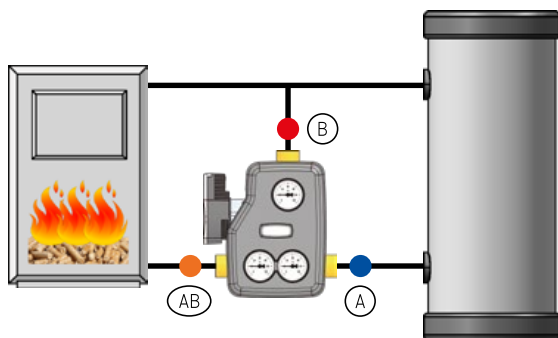

Installation placed on the right of the heating source.

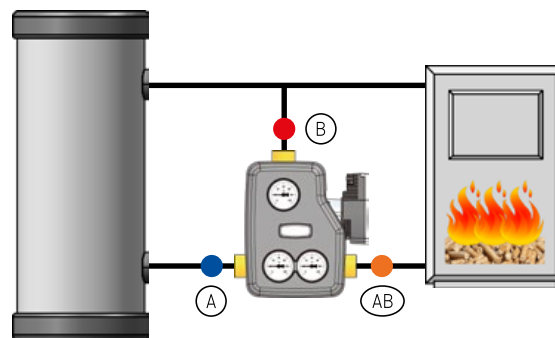

Installation placed on the left of the heating source.

Code composition: the suffix "xx" shows the setting temperature of the thermic valve; example: **204MCCS-55-P8** (setting temperature 55°C)



Code 1": **204MCCS-xx-P8**
Code 1 1/4": **205MCCS-xx-P8**
Code 28 mm: **228MCCS-xx-P8**



**Synchronous
circulating pump:**
Wilo Para SC/8 (P8)

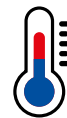

**Available calibration
temperatures:**

45 = 45 °C
55 = 55 °C
60 = 60 °C
72 = 72 °C

PED 2014/68/EU 4.3



FIELD OF USE

For power up to 90 kW (with Δt 30 K) and maximum flow rate 2600 l/h.

For an accurate sizing or for higher flow rates, please refer to the curves in the technical section.

Operating principle

The schemes shown below represent the different working phases of the anti-condensation pump unit.



Note: the pictures have to be considered just as an indication and they have no completeness pretention.

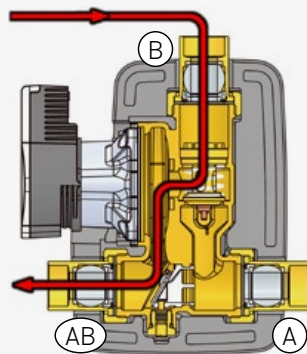

① Start-up of the system (heating of the boiler)

When the boiler is switched on, the thermic valve is completely closed towards the user's return (**port A**) and this condition remains until the fluid, heated by the heat generator, reaches the opening temperature of the thermic valve (corresponding to that of calibration, for example 55°C).

During this phase, the fluid delivered by the boiler recirculates internally towards the by-pass (**port B**) and the boiler temperature rises quickly.

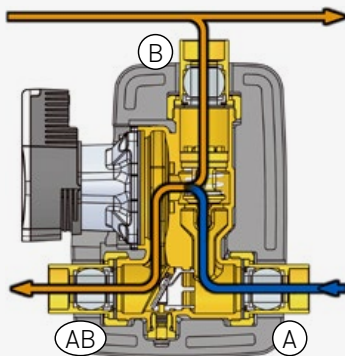

② Loading the system (heating the buffer tank)

When the opening temperature is reached (e.g. 55°C), the user's return (**port A**) is proportionally opened while, at the same time, the by-pass (**port B**) is closed.

The boiler temperature rises slowly, giving energy to the user, but in any case the return temperature will no longer fall below the calibration one (e.g. 55°C).

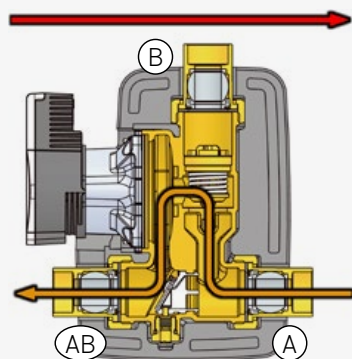

③ Fully operational system

Starting from the condition reported in point 2, the supply temperature progressively rises up to the full opening of the thermic valve (**port A**) and up to the corresponding shutting of the by-pass (**port B**).

This occurs at about 10 K higher than the opening or calibration temperature (therefore in the example at about 65°C). At this point the system is in operation and the delivery fluid temperature can rise up to the set value.

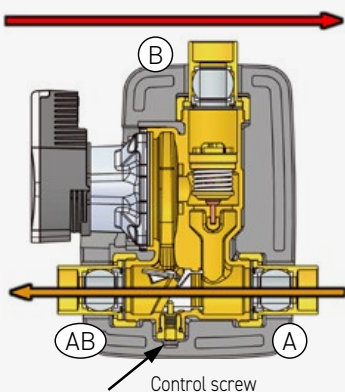

④ Natural circulation

The natural circulation of the fluid through the clapet valve is activated as soon as the circulating pump stops and the remaining energy in the generator is transferred to the tank.

This function is activated as a safety device in the event of the pump being stopped due to blackout or failure of pump, thus preventing the temperature in the heating source from reaching high levels of danger. To activate the natural circulation function, unscrew the control screw counterclockwise.

It is possible to lock the clapet at any time by screwing the screw clockwise (operation to be done with the circulating pump running)

Art. 745-3

ANTI-CONDENSATION PUMP UNIT WITH ELECTRONIC CONTROL

Function

The anti-condensation recirculation pump unit allows to connect directly the solid fuel heating source to the heating system or to the buffer tank without the aid of other devices. In fact, the unit encloses the circulating pump, the anti-condensation thermic valve, the electronically controlled mixing valve, the excludable natural circulation clapet valve, isolating valves and thermometers in a compact and elegant insulation. It automatically adjusts the temperature of the water returning to the generator to the calibration value of the chosen thermostat.

The device keeps the heat generator at a high temperature (always above that of condensation) in any condition of use, avoiding the formation of sediments both in the boiler and in the chimney flue, thus improving its efficiency and life. Corrosion of the generator or dangerous flue chimney fires are therefore avoided.

Features

Anti-condensation recirculation and distribution pump unit with electronic control of the return temperature to solid fuel heating sources. Cast brass body CB753S. Yellow brass execution.

- Synchronous high efficiency Wilo Para SC/8.
- Maximum working pressure: 10 bar.
- Maximum temperature: 100°C.
- Mixing valve with fixed temperature actuator.
- Adjustable diverting temperature from 5 up to 95°C.
- PT1000 contact temperature sensor with fixing kit to be mounted on the pipe.
- Natural circulation clapet valve: with external control, it can be set on or off according to the type of installation.
- Temperature thermometers: 0-120°C.

Diverting temperature: adjustable from 10 up to 90°C.

Available external connections: 1" and 1 1/4" female, 28 mm for copper pipe.

Installation

The anti-condensation recirculation pump unit can be placed on both sides of the heating source, following these directions:

- On the return pipe to the boiler in mixing mode, following the flow directions shown on the body.
- In vertical position (horizontal circulating pump axis) to allow the hydraulic working of the natural circulation clapet valve.

In order to optimize the anti-condensation control, it is recommended the installation of the unit on the return way to the boiler.

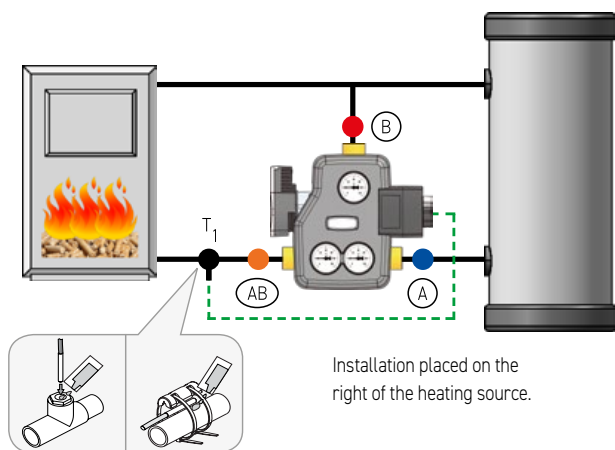

Code 1": 204MCCS-P8-(ACC/M21)
Code 1 1/4": 205MCCS-P8-(ACC/M21)
Code 28 mm: 228MCCS-P8-(ACC/M21)



Synchronous circulating pump:
Wilo Para SC/8 (P8)

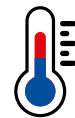

Diverting temperature:
adjustable from 10 up to 90°C.

PED 2014/68/EU 4.3



FIELD OF USE

For power up to 90 kW (with Δt 30 K) and maximum flow rate 2600 l/h.
For an accurate sizing or for higher flow rates, please refer to the curves in the technical section.

A version with 3 point actuator is also available (code with final part ...-M21).
In this case an electronic external controller is required.

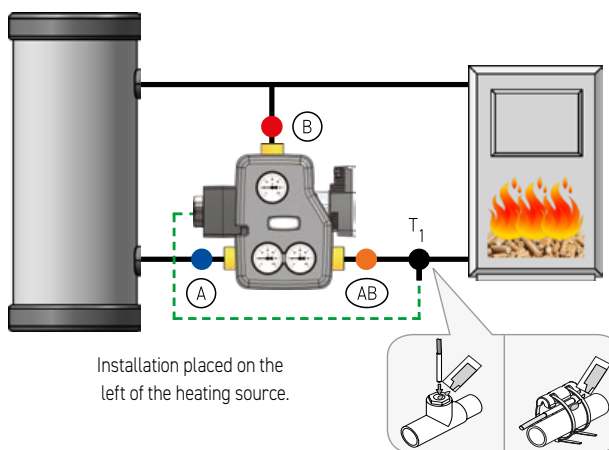

Operating principle

The schemes shown below represent the different working phases of the anti-condensation pump unit.

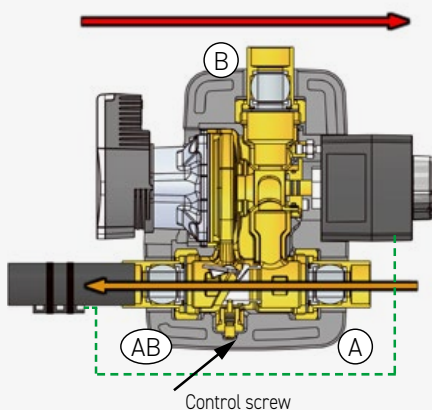
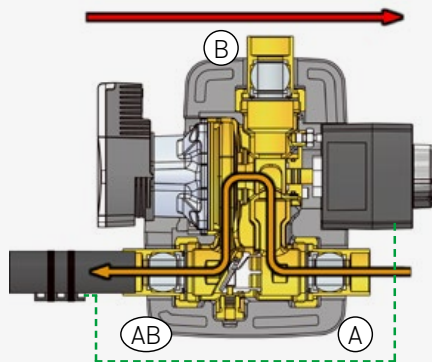
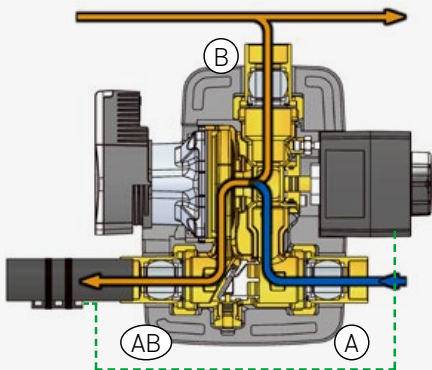
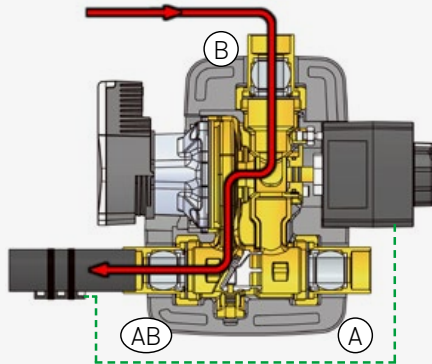

Note: the pictures have to be considered just as an indication and they have no completeness pretention.

① Start-up of the system (boiler heating)

When the boiler is switched on, the thermic valve is completely closed towards the user's return (**port A**) and this condition remains until the fluid, heated by the heat generator, reaches the opening temperature of the thermic valve (corresponding to that of calibration, for example 55°C).

During this phase, the fluid delivered by the boiler recirculates internally towards the by-pass (**port B**) and the boiler temperature rises quickly.

② Loading the system (heating the buffer tank)

When the opening temperature is reached (e.g. 60°C), the user's return (**port A**) is proportionally opened while, at the same time, the by-pass (**port B**) is closed.

The boiler temperature rises slowly, giving energy to the user, but in any case the return temperature will no longer fall below the calibration one (e.g. 60°C).

③ Fully operational system

Starting from the condition reported in point 2, the supply temperature progressively rises up to the full opening of the thermic valve (**port A**) and up to the corresponding shutting of the by-pass (**port B**).

It is possible to change the parameters of the actuator to make more or less reactive the shift from closed to open mixing valve, according to the features of the installation and to the power of the heating source. Now the installation is in operation and the supply fluid temperature can rise up to the set value.

④ Natural circulation

The natural circulation of the fluid through the clapet valve is activated as soon as the circulating pump stops and the remaining energy in the generator is transferred to the tank.

This function is activated as a safety device in the event of the pump being stopped due to blackout or failure of pump, thus preventing the temperature in the heating source from reaching high levels of danger. To activate the natural circulation function, unscrew the control screw counterclockwise.

It is possible to lock the clapet at any time by screwing the screw clockwise (operation to be done with the circulating pump running).

Art. 745 and Art. 745-3
CHECKING OF WORKING CONDITIONS

To show a realistic example, we take into account the following starting values:

- Heating source power: **28 kW**
- Δt value: **20 K**

The side diagram shows that the flow rate of **1.2 m³/h** is a consequence of these choices.

In the diagram of the circulating pump, at the bottom of the page, it is possible to cross geometrically this flow rate value with the curve of the selected speed. In correspondence with this crossing it is possible to read on the scale on the left side the head developed by the pump in these conditions. The Para SC/8 pump develops a **5.8 mH₂O** head in correspondence of curve II.

In the specific case of our example, if this head is not enough for the installation needs, a higher speed of the pump should be selected: Curve III.

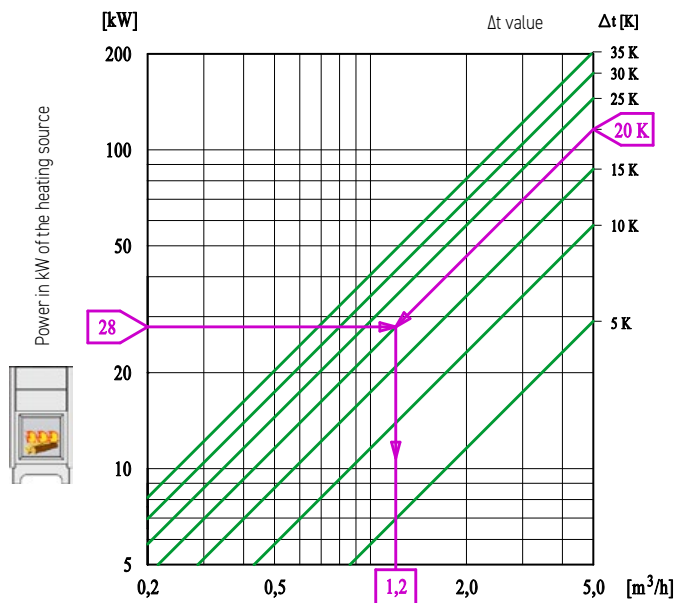

**Hydraulic performances of the pump units
(A towards AB)**

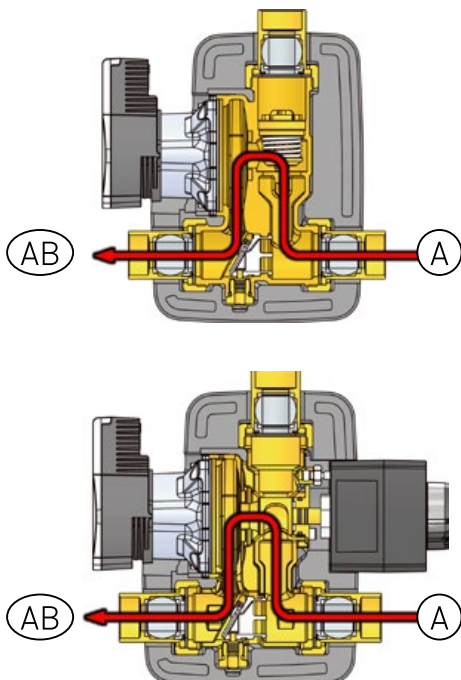

Synchronous circulating pump Wilo Para SC/8

Consumption: 10-75 W
Recommended operating mode:
Constant speed

- Maximum speed (III)
- Medium speed (II)
- Minimum speed (I)

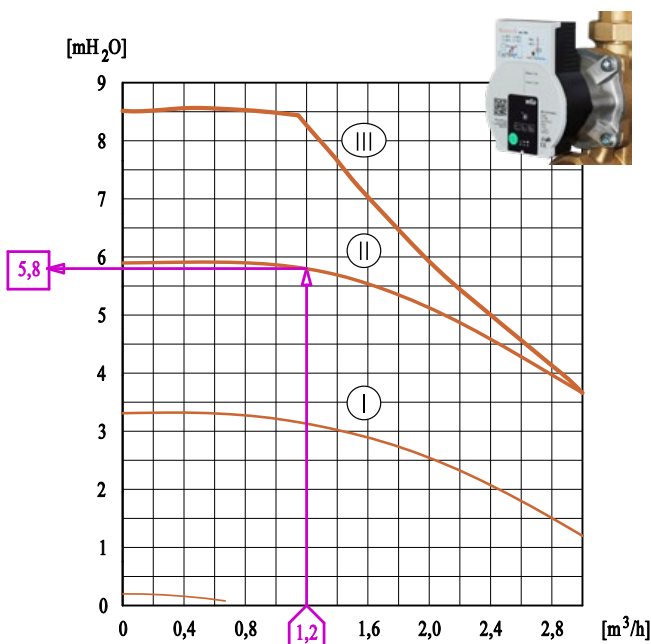

BIOMASS

FIELD OF USE

Direct supply to the zone manifold: up to 45 kW (with Δt 20 K) and maximum flow rate rate of 1950 l/h. Lifting power: 4 mH₂O

With buffer tank: up to 90 kW (con Δt 30 K) and maximum flow rate rate of 2600 l/h. Lifting power: 2 mH₂O

These performances are substantially the same even in case of recirculation flow (B towards AB).

Art. 654

FLOWMETER WITH FLOW REGULATOR

Straight flowmeter with flow regulation, male threaded on both ends, from 3/4" to 1 1/2", for solar, heating and hydronic applications. Direct reading of the flowrate through the graduated scale.

Ball valve for flow rate adjustment. A careful sizing of the article provides very little headlosses.

PN 10. Constant temperature 120°C;
(short time temperature: 160°C for 20 s).

External connections

- DN15: 22 mm compression, 3/4" and 1".
- DN20: 1", 1 1/4 and 1 1/2".

Code 22 mm: **22654DN15-xx**
Code 3/4" Male: **03654DN15-xx**
Code 1" Male: **04654DN(15/20)-xx**
Code 1 1/4 Male: **05654DN20-xx**
Code 1 1/2 Male: **06654DN20-xx**



Flow rate ranges for DN15

06 = 1-6 l/min 12 = 2-12 l/min
28 = 8-28 l/min 38 = 8-38 l/min



Flow rate ranges for DN20

42 = 5-42 l/min
70 = 20-70 l/min

PED 2014/68/EU 4.3



Art. 654 P

FLOWMETER WITH FLOW REGULATOR

Straight flowmeter with flow regulation, male threaded on one end and with swivel nut on the other, from 3/4" to 1 1/2", for solar, heating and hydronic applications. Direct reading of the flowrate through the graduated scale.

Ball valve for flow rate adjustment. A careful sizing of the article provides very little headlosses.

PN 10. Constant temperature 120°C;
(short time temperature: 160°C for 20 s).

External connections

- DN15: 3/4" and 1".
- DN20: 1 1/4 and 1 1/2".

Code 3/4" Male: **03654DN15P-xx**
Code 1" Male: **04654DN15P-xx**
Code 1 1/4 Male: **05654DN20P-xx**
Code 1 1/2 Male: **06654DN20P-xx**



Flow rate ranges for DN15

06 = 1-6 l/min 12 = 2-12 l/min
28 = 8-28 l/min 38 = 8-38 l/min



Flow rate ranges for DN20

42 = 5-42 l/min
70 = 20-70 l/min

PED 2014/68/EU 4.3

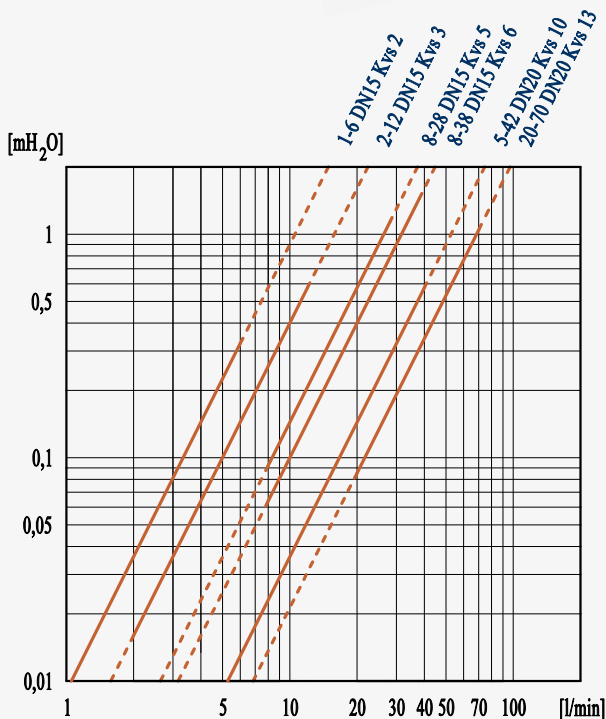

Art. 654 Adapters for capillary welding

Copper pipe adapter set: adapter 15 mm for 3/4" connection and 22 mm for 1" connection. For more informations see the pages dedicated to **ModvSol Equipments and Accessories**.

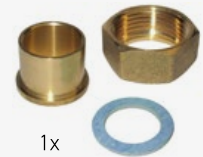

Cooling

min. -20°C (with glycol solution)



To obtain the real flow rate with the use of low temperature glycol solutions, it is necessary to multiply the value indicated by the flowmeter by a corrective factor, equal to:

- **0.9** for concentrations of **20-30%**
- **0.8** for concentrations of **40-50%**

CODE COMPOSITION

"xx" means the flow rate range to be read/set on the component.



Adjustment:
The flow rate reading is to be done at the lower part of the mobile indicator.

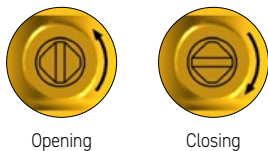

8 l/min

The valve can be mounted horizontally or vertically with any direction of flow. For an accurate and stable reading please provide a straight pipe with an overall length of at least 5 times the diameter of the pipe.

Art. 654 GPM
GPM FLOWMETER WITH FLOW REGULATOR

Straight flowmeter with flow regulation, male threaded on both ends to ISO 228, for solar, heating and hydronic applications, special for the North-American market. Thanks to use of dedicated brass adapters (which can be purchased separately) it is possible the capillary welding connection with pipes in compliance with ASTM specifications. Direct reading of the flowrate through the graduated scale. Ball valve for flow rate adjustment. A careful sizing of the article provides very little headlosses.
PN 10 (150 psi). Constant temperature 120°C (250°F).
Short time temperature: 160°C (320°F) for 20 s.

Available external connections

• DN15: 3/4" e 1" ISO 228.

Code 3/4" Male: **03654DN15GPM-x**

Code 1" Male: **04654DN15GPM-x**



Low rate ranges for DN15

3 = 0.5-3 US gpm (gallons per minute)

8 = 2-8 US gpm (gallons per minute)

PED 2014/68/EU 4.3



0,5-3 DN15 Cy 3,5
2-8 DN15 Cy 5,8

Art. 654 adapters for capillary welding

The set consists of 3/4" nut, welding connection for 1/2 in. pipe and fiber plain gasket. In compliance with ASTM specifications.

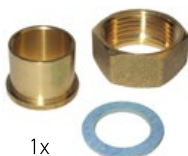

1x

Code for 1/2 in. pipe: **03654ASTMSET**

The set consists of 1" nut, welding connection for 3/4 in. pipe and fiber plain gasket. In compliance with ASTM specifications.

Code for 3/4 in. pipe: **04654ASTMSET**

NPT to GAS adapter

The set consists of F/F connection and fiber plain gasket.
Available sizes: 3/4" NPT x 3/4" G and 1" NPT x 1" G.



1x

Code 3/4": **03641NPTSET**

Code 1": **04641NPTSET**

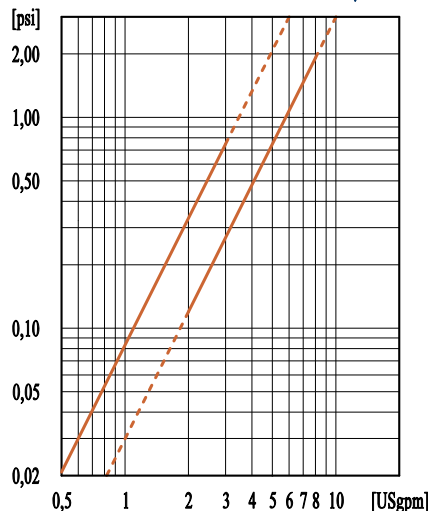

CODE COMPOSITION

"x" means the flow rate range to be read/set on the component.

FLOWMETERS

Art. 510 - 51F

F/F full port ball valve in hot forged brass.

Nickel plated. Ends threaded to ISO 228 (DIN 259 BSP 2779).
PN 30 (PN 25 for 2"1/2, 3" and 4"). Max Temperature 150°C.

Art. 510: Provided with steel handle PVC covered.

Sizes: from 1/4" up to 4".

Art. 51F: Provided with steel T-handle.

Sizes: from 1/4" up to 1"1/4.

Codes for series 510: **xx510 (from 00510 to 0A510)**

Codes for series 51F: **xx51F (from 0051F to 0551F)**

For the sizes corresponding to "xx"
see notes



Art. 51F

Art. 510

Art. 520 - 52F Heavy line

F/F "heavy body" full port ball valve in hot forged brass.

Nickel plated. Ends threaded to ISO 228 (DIN 259 BSP 2779).
PN 40. Max Temperature 150°C.

Art. 520: Provided with steel handle PVC covered.

Sizes: from 1/2" up to 2".

Art. 52F: Provided with steel T-handle.

Sizes: from 1/2" up to 1"1/4.

Codes for series 520: **xx520 (from 02520 to 07520)**

Codes for series 52F: **xx52F (from 0252F to 0552F)**

For the sizes corresponding to "xx"
see notes



Art. 52F

Art. 520

Art. 560 - 56F

M/F full port ball valve in hot forged brass.

Nickel plated. Ends threaded to ISO 228 (DIN 259 BSP 2779).
PN 30. Max Temperature 150°C.

Art. 560: Provided with steel handle PVC covered.

Sizes: from 1/4" up to 2".

Art. 56F: Provided with steel T-handle.

Sizes: from 1/4" up to 1"1/4.

Codes for series 560: **xx560 (from 00560 to 07560)**

Codes for series 56F: **xx56F (from 0056F to 0556F)**

For the sizes corresponding to "xx"
see notes



Art. 56F

Art. 560

Art. 566 - 566F

M/M full port ball valve in hot forged brass.

Nickel plated. Ends threaded to ISO 228 (DIN 259 BSP 2779).
PN 30. Max Temperature 150°C.

Art. 566: Provided with steel handle PVC covered.

Sizes: 1/2", 3/4" and 1".

Art. 566F: Provided with steel T-handle.

Sizes: 1/2", 3/4" and 1".

Codes for series 566: **xx566 (from 02566 to 04566)**

Codes for series 566F: **xx566F (from 02566F to 04566F)**

For the sizes corresponding to "xx"
see notes



Art. 566F

Art. 566

Art. 569 - 569F

Full port ball valve with union in hot forged brass.

Nickel plated. Ends threaded to ISO 228 (DIN 259 BSP 2779).
PN 16. Max Temperature 95°C.

Art. 569: Provided with steel handle PVC covered.

Sizes: 1/2", 3/4" e 1".

Art. 569F: Provided with steel T-handle.

Sizes: 1/2", 3/4" e 1".

Codes for series 569: **xx569 (from 02569 to 04569)**

Codes for series 569F: **xx569F (from 02569F to 04569F)**

For the sizes corresponding to "xx"
see notes



Art. 569F

Art. 569

CHECKBALL series with integrated check valve

Art. 620 - 62F

F/F ball valve in hot forged brass with check valve built into the ball that can be excluded by rotating the handle by 45°. Nickel plated. Ends threaded to ISO 228 (DIN 259 BSP 2779). **PN 16. Max Temperature 95°C.**

Art. 620: Provided with steel handle PVC covered.

Art. 62F: Provided with steel T-handle.

Sizes: 1/2", 3/4" and 1".

Codes for series 620: **xx620 (from 02620 to 04620)**

Codes for series 62F: **xx62F (from 0262F to 0462F)**

For the sizes corresponding to "xx" see notes



Art. 660 - 66F

M/F ball valve in hot forged brass with check valve built into the ball that can be excluded by rotating the handle by 45°. Nickel plated. Ends threaded to ISO 228 (DIN 259 BSP 2779). **PN 16. Max Temperature 95°C.**

Art. 660: Provided with steel handle PVC covered.

Art. 66F: Provided with steel T-handle.

Sizes: 1/2", 3/4" and 1".

Codes for series 660: **xx660 (from 02660 to 04660)**

Codes for series 66F: **xx66F (from 0266F to 0466F)**

For the sizes corresponding to "xx" see notes



Ball valves for meters and heat/cooling energy meters

Art. 557

Ball valve in hot forged brass for DN15 water meters (Qn 1.5). Nickel plated. Ends threaded to ISO 228 (DIN 259 BSP 2779). Sealable coupling nut. Provided with steel T-handle.

PN 30. Max Temperature 150°C. Size: 1/2" x 3/4" Coupling nut.

Code 1/2": **0328**



Art. 553

Ball valve in hot forged brass for DN25 water meters (Qn 2.5). Nickel plated. Ends threaded to ISO 228 (DIN 259 BSP 2779). Sealable coupling nut. Provided with steel T-handle.

PN 30. Max Temperature 150°C. Size: 3/4" x 1" Coupling nut.

Code 3/4": **0319**



Art. 518

F/F full port ball valve in hot forged brass with sealable M10x1 connection for ø5 mm temperature sensor. Nickel plated. Ends threaded to ISO 228 (DIN 259 BSP 2779). Provided with steel T-handle.

PN 30. Max Temperature 150°C.

Code 1/2": **02518**

Code 3/4": **03518**



Sizes:

1/2" (for DN15 heat/cooling energy meters; Qn 1.5)

3/4" (for DN20 heat/cooling energy meters; Qn 2.5)

Note: the prefix "xx" means the size of the article, with the following matches:

1/4": xx = 00
3/8": xx = 01
1/2": xx = 02

3/4": xx = 03
1": xx = 04
1 1/4": xx = 05

1 1/2": xx = 06
2": xx = 07
2 1/2": xx = 08

3": xx = 09
4": xx = 0A

Art. 520 ISO
BALL VALVES

F/F full port ball valve in hot forged brass.
Nickel plate finish.
Ends threaded to ISO 228 (DIN 259 BSP 2779).
Provided with insulation T-handle.
Individual package.
PN 40. Max Temperature 120°C.
Sizes: from 1/2" up to 1 1/4".

Code 1/2": **02520ISO**
Code 3/4": **03520ISO**
Code 1": **04520ISO**
Code 1 1/4": **05520ISO**



Art. 520 TER
BALL VALVE WITH THERMOMETER

F/F full port ball valve in hot forged brass.
Nickel plate finish.
Ends threaded to ISO 228 (DIN 259 BSP 2779).
Supplied with in-handle thermometer, red ring (range 0°C-120°C, TER-R) or blue ring (range 0°C-120°C, TER-B).
Individual package.
PN 40. Max Temperature 120°C.
Sizes: from 1/2" up to 1 1/4".

Code 1/2": **02520TER-(R/B)**
Code 3/4": **03520TER-(R/B)**
Code 1": **04520TER-(R/B)**
Code 1 1/4": **05520TER-(R/B)**



Art. 514
FILTER BALL VALVE

F/F Ball valve with filter in hot forged brass.
To fill the system. Nickel plated.
End threaded to ISO 228 (DIN 259 BSP 2779).
Provided with steel handle, PVC covered. Individual or multiple package.
Stainless steel filtering mesh: 0.5 mm. PN 16.
Max Temperature 120°C.
Size: 1/2", 3/4", 1", 1 1/4 and 1 1/2".

Kvs values:
• 1/2" : 5,3
• 3/4" : 5,6
• 1" : 12,0
• 1 1/4" : 20,0
• 1 1/2" : 40,0



Individual package
Code 1/2": **02514/A**
Code 3/4": **03514/A**
Code 1": **04514/A**
Code 1 1/4": **05514/A**
Code 1 1/2": **06514/A**

Multiple package
Code 1/2": **02514**
Code 3/4": **03514**
Code 1": **04514**
Code 1 1/4": **05514**
Code 1 1/2": **06514**

New size 1 1/2

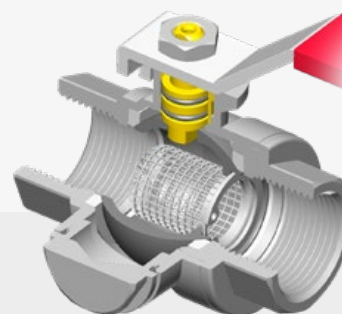

The stainless steel filter placed inside the ball can be easily removed, to be cleaned and inspected, while the valve is in closed position.

The ball valve can be installed either with or without the filter (in this case the filter can be used for a limited time only, for example to clean the system).



SigilBlock

SigilBlock is a special safety device patented by BRV. It can be put on the valves provided both with lever handles and with "T" handles and allows to lock the valve in fully closed or fully open position, according to the required operating conditions.

SigilBlock, if compared to other locking systems, is a very flexible and good value device: it can be mounted on any standard BRV ball valve, both on the old models and on the new ones. Thanks to the compact size, it is space saving.

To mount it, it's necessary to replace the nut of the standard handle with the special nut of the locking device and then to put the cap; once it is fitted, it can be removed only by authorized personnel, thanks to the special key.

Special safety device that allows to lock the valve in open or closed position. It consists of a specific nut and a Sigilblock cap. Chrome finish. It is possible to fit it both on lever handles and on "T" handles.

Sizes

- for valves from 1/4" up to 3/4" (from DN10 to DN20)
- for valves 1" and 1 1/4" (DN25 and DN32)
- for valves 1 1/2" and 2" (DN40 and DN50)

Exception

As concerns the filter ball valves (Art. 514, 514P, 564P) the size to be used is the 2nd. For the art. 514 1 1/4" the size to be used is the 3rd.

Code 1st size: **DJRW03SET**

Code 2nd size: **DJRW05SET**

Code 3rd size: **DJRW07SET**



How to fit Sigilblock device for locking a valve

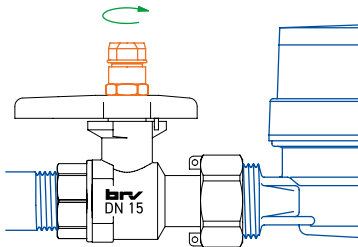

Remove the nut of the handle.

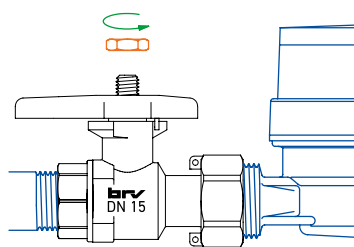

Screw the special nut and turn the handle to fully open or closed position.

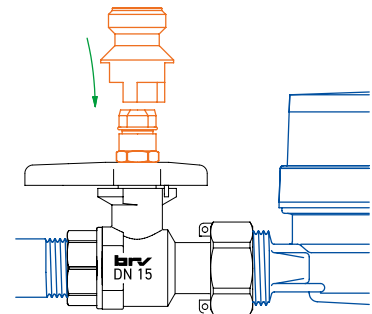

Insert the Sigilblock cap up to the click.

How to remove Sigilblock cap to operate the valve

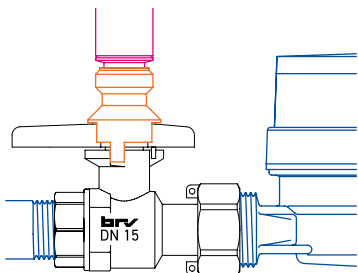

Insert the special Sigilblock key and, keeping it pressed, pull the cap to the click.

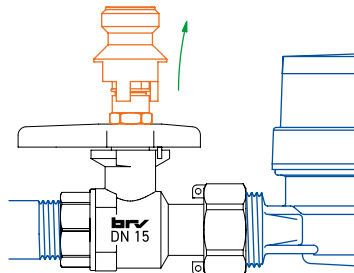

Take off the key and pull out the cap. Now you can operate the ball valve.

The thermostatic radiator valve **Thermostar**

The thermostatic radiator valve **Thermostar** is a device that allows to adjust the operation of each individual heating element in complete autonomy, stabilizing the temperature inside the room where it is installed.

Benefits

Thermostar mainly satisfies the almost always required need to have different temperatures in the individual rooms of a flat/house.

By independently adjusting the power emitted by the heating body, at the same time, a higher level of comfort and considerable energy saving, which on average is quantified in the order of 20%, are achieved.

Operation principle

The first operation performed by the **Thermostar** valve is to sense the ambient temperature.

A sensor mounted inside the adjustment knob, having expansion properties proportional to the increase or decrease in temperature, sensing even a slight variation in it, appropriately controls the action of the valve by closing or opening the valve's shutter.

This system allows to take full advantage not only of the heat produced free of charge from other sources, such as solar energy, but also of that generated by sources not conventionally recognized as such, that is, for example, household appliances, light sources, and the people themselves who are in the environment. The "**Thermostar**" system guarantees the constancy of the set temperature.



Since 1998

Robotized assembly shop to mount and to calibrate the thermostatic heads.

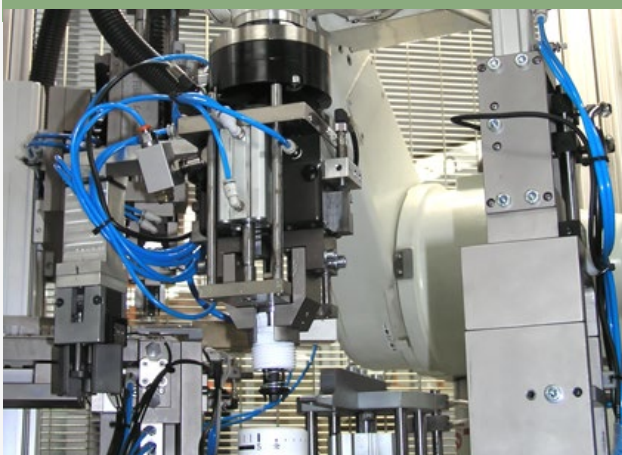

STANDARD PRODUCTS

TELL

Thermostatic Efficiency Label



Manufacturer	BRV
Product	T10H750H
Reg.-No.	10732-20220331

Energy



www.tell-online.eu



To see the large of the available valves in addition to the above mentioned ones, visit the web site: <http://www.brv.it>

Art. 750H

THERMOSTATIC CONVERTIBLE RADIATOR ANGLE TYPE VALVE

Thermostatic convertible radiator valve, M30x1.5 compatible.
Body in hot forged and sand-blasted brass.
Nickel plated finish. Angle model for steel pipe.
End threaded to ISO 228 (DIN 259 BSP 2779).
Radiator connection threaded to ISO 7/1 (DIN 2999 BS 21).

Fixed Kvs-value • EN215 approved
Thermostatic head code 5100H is required
PN 10. Max Temperature 120°C.
Sizes: 3/8" and 1/2".

Code 3/8": **5001H** - 1/2": **5002H**



Art. 755H

THERMOSTATIC CONVERTIBLE RADIATOR STRAIGHT TYPE VALVE

Thermostatic convertible radiator valve, M30x1.5 compatible.
Body in hot forged and sand-blasted brass.
Nickel plated finish. Straight model for steel pipe.
End threaded to ISO 228 (DIN 259 BSP 2779).
Radiator connection threaded to ISO 7/1 (DIN 2999 BS 21).

Fixed Kvs-value • EN215 approved
Thermostatic head code 5100H is required
PN 10. Max Temperature 120°C.
Sizes: 3/8" and 1/2".

Code: 3/8": **5051H** - 1/2": **5052H**



Art. T10H

THERMOSTATIC CONTROL HEAD

Thermostatic control head with liquid gas sensor. M30x1.5 compatible.
EN215 Approval and TELL (Thermostatic Efficiency Label) certification that qualifies the product in Energetic Class I.
Ambient temperature setting range from 6°C (frost protection) up to 28°C.
Clips to limit the temperature and to lock the knob.

Thermic hysteresis 0.34 K
"Variation Temporelle" calculated coefficient: 0.29 K.

Code: **5100H**



To see the large of the available valves in addition to the above mentioned ones, visit the web site: <http://www.brv.it>

From the beginning BRV has been dynamic and innovative. BRV's mission has always been complete customer satisfaction.

Over the last few years we have been intensely dedicated to custom-made products for which we have invested in highly flexible machinery. This also allowed BRV to work closely with the customer for the development of new products. Thanks to our highly specialized staff, we are able to create a working prototype from the initial 3D project in less than a week (with rapid prototyping techniques in stereolithography or CAM milling on a machining center).

The design and implementation of new products today benefit from the use of modern CAD/CAM systems.

In fact, thanks to these systems, the procedure for making finished products through all the design phases is considerably reduced in terms of time.

Furthermore, the production processes can be simulated to ensure their feasibility and efficiency, thus allowing a better organization of production.

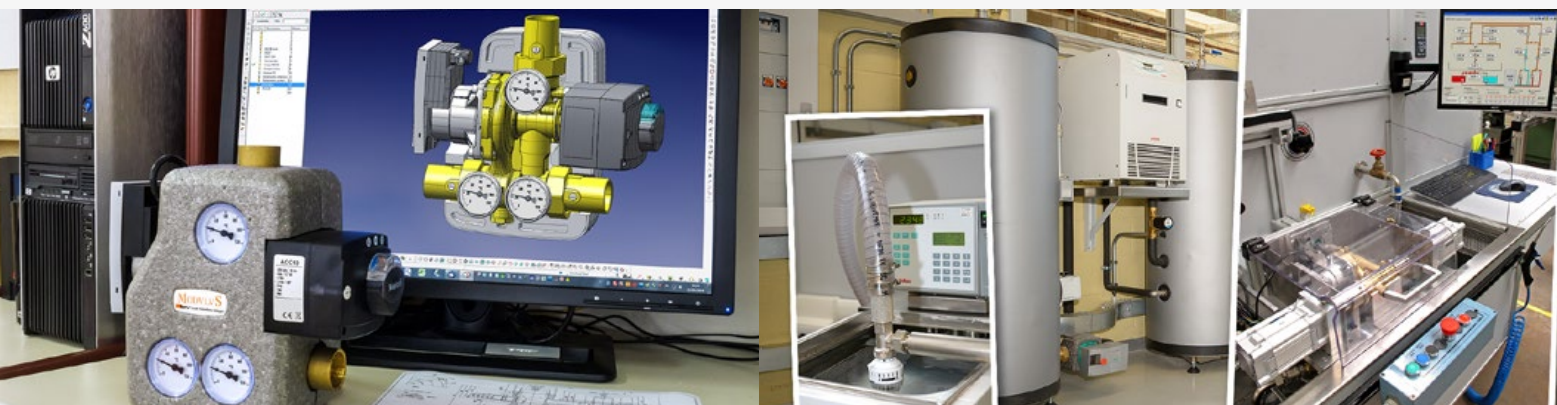

Precise and detailed prototyping thanks to multi-axis CNC milling.

The accuracy of the measurements and the aesthetic appearance in the samples and prototypes reach high standards, thanks to the versatility of the CAD/CAM systems that allow to obtain details that are practically identical to those that can be obtained from mass production.

The well-equipped testing laboratory, inside the company, can validate the performance of new projects even during the prototyping phases.



A video showing the steps to make a prototype by means our numerical control machining center is **available upon request.**

Thanks to the modern milling techniques offered by the most recent CAM systems, autonomy in the production of processing equipment, even the most complex, has been consolidated.

Clamps for piece gripping, grippers for robotic loading and unloading, stands for production lines, are all made ofternally.

The entire design cycle of custom- made products, and subsequent series production, is therefore managed with a view to maximum versatility.

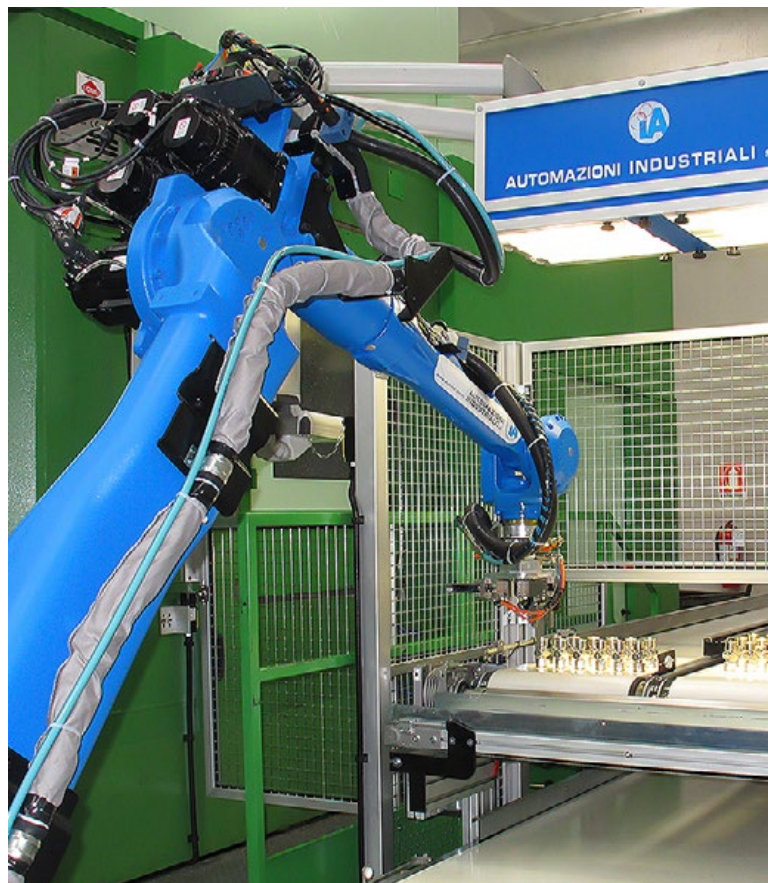

Modern production plants assisted by robotic loading systems and equipped with vision allow high flexibility and efficiency, especially for particularly diversified components such as custom- made products.

Various types of production machines allow to face any machining need in the most appropriate way, without compromise, to the full advantage of the customer.



CUSTOM-MADE

Wilo Para SC 15/6

Manufacturer's references:

15/6-43/SC

4531488

4533205 (for ModvBox)

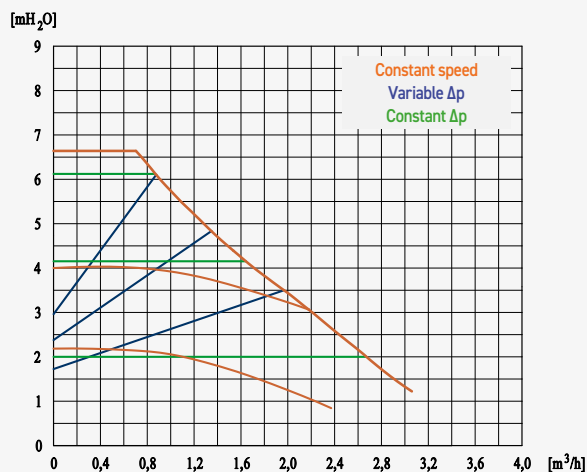
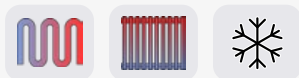

Lenght	Connection	Control modes	Power consumpt.	I max	PN	Temp. range	Electrical connection	EEl
130 mm	1"	Δp-v / Δp-c / Constant speed	3-43 W	0,44 A	PN10	0 ÷ 95 °C	230 VAC, 50/60 Hz	≤ 0.20

Grundfos UPM3S Auto 15-60

Manufacturer's references:

UPM3S AUTO 15-60 130 ZZZ

92683531

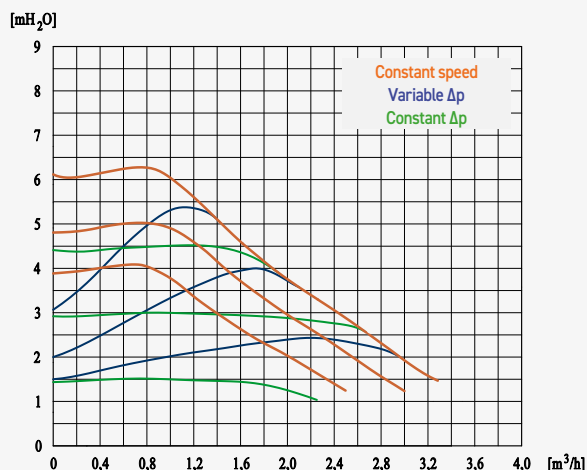
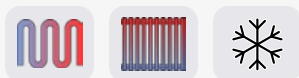

Lenght	Connection	Control modes	Power consumpt.	I max	PN	Temp. range	Electrical connection	EEl
130 mm	1"	Δp-v / Δp-c / Constant speed / Auto	2-42 W	0,40 A	PN10	2 ÷ 110 °C	230 VAC, 50/60 Hz	≤ 0.20

Wilo Para SC 15/8

Manufacturer's references:

15/8-75/SC

4531486

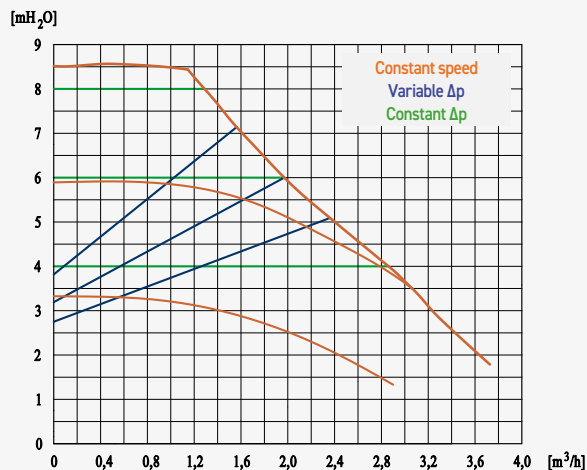
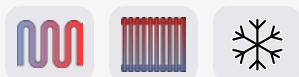

Lenght	Connection	Control modes	Power consumpt.	I max	PN	Temp. range	Electrical connection	EEl
130 mm	1"	Δp-v / Δp-c / Constant speed	10-75 W	0,66 A	PN10	0 ÷ 95 °C	230 VAC, 50/60 Hz	≤ 0.21

Wilo Para SC 25/6

Manufacturer's references:
25/6-43/SC
4531347

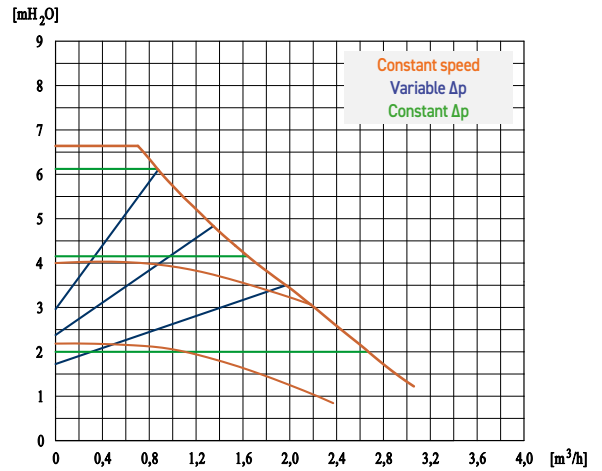

Lenght	Connection	Control modes	Power consumpt.	I max	PN	Temp. range	Electrical connection	EEI
180 mm	1"1/2	Δp-v / Δp-c / Constant speed	3-43 W	0,44 A	PN10	0 ÷ 95 °C	230 VAC, 50/60 Hz	≤ 0.20

Grundfos UPM3S Auto 25-60

Manufacturer's references:
UPM3S AUTO 25-60 180 ZZZ
92683508

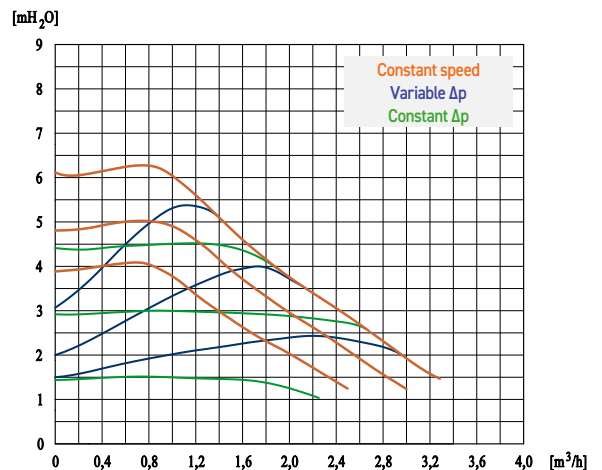

Lenght	Connection	Control modes	Power consumpt.	I max	PN	Temp. range	Electrical connection	EEI
180 mm	1"1/2	Δp-v / Δp-c / Constant speed / Auto	2-42 W	0,40 A	PN10	2 ÷ 110 °C	230 VAC, 50/60 Hz	≤ 0.20

Wilo Para SC 25/8

Manufacturer's references:
25/8-75/SC
4531345
4531449 (for MCCS)

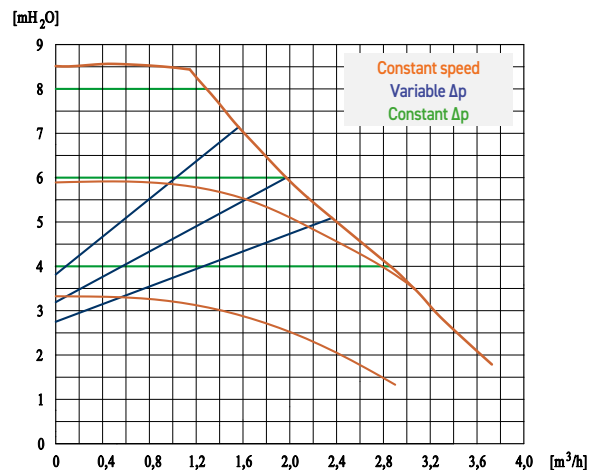
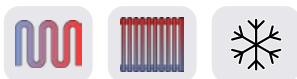

Lenght	Connection	Control modes	Power consumpt.	I max	PN	Temp. range	Electrical connection	EEI
180 mm	1"1/2	Δp-v / Δp-c / Constant speed	10-75 W	0,66 A	PN10	0 ÷ 95 °C	230 VAC, 50/60 Hz	≤ 0.21

Grundfos Alpha 1 32-60

Manufacturer's references:
ALPHA1 L MODEL B
99199581

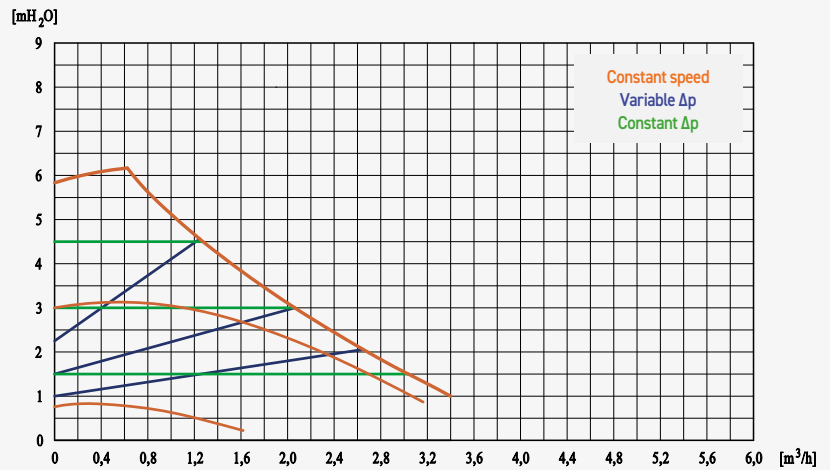

Length	Connection	Control modes	Power consumpt.	I max	PN	Temp. range	Electrical connection	EEI
180 mm	2"	Δp-v / Δp-c / Constant speed	4-34 W	0,32 A	PN10	0 ÷ 110 °C	230 VAC, 50/60 Hz	≤ 0.20

Wilo Para SC 30/8

Manufacturer's references:
30/8-75/SC
4532300

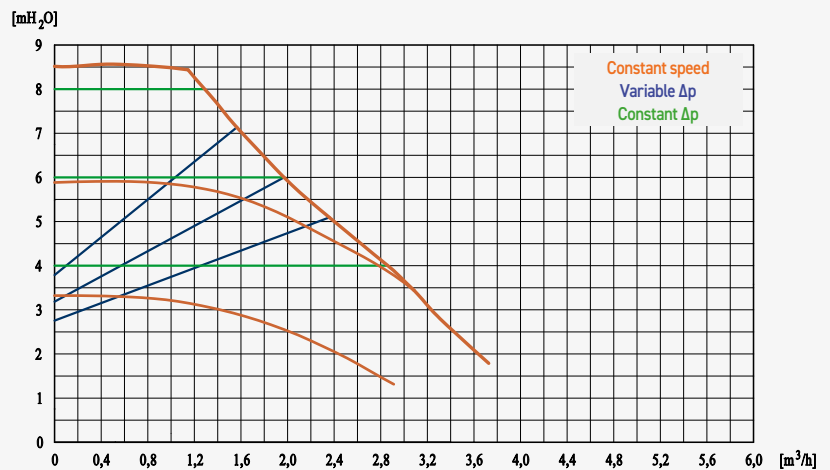
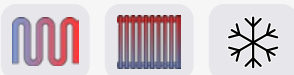

Length	Connection	Control modes	Power consumpt.	I max	PN	Temp. range	Electrical connection	EEI
180 mm	2"	Δp-v / Δp-c / Constant speed	10-75 W	0,66 A	PN10	0 ÷ 95 °C	230 VAC, 50/60 Hz	≤ 0.21

Wilo Para Maxo 30-180-08

Manufacturer's references:
Para MAXO 30-180-08-F02
U03-S BRV
2225097



PWM 1 - Heating
PWM 2 - Solar

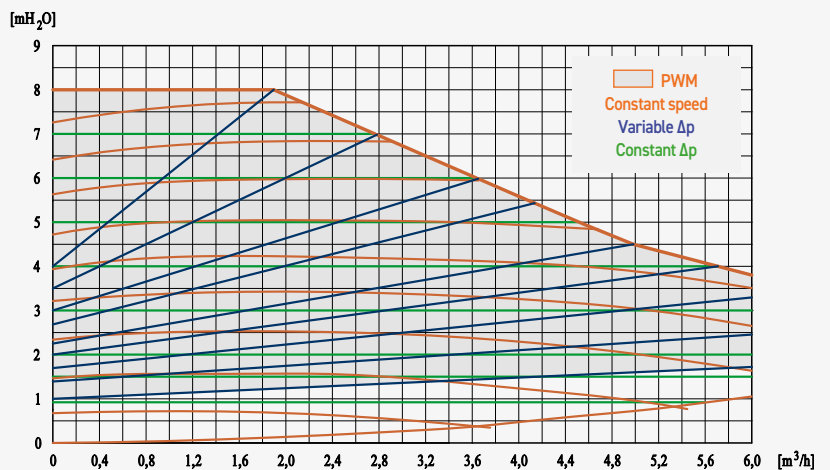

Length	Connection	Control modes	Power consumpt.	I max	PN	Temp. range	Electrical connection	EEI
180 mm	2"	Δp-v / Δp-c / const. speed / PWM / 0-10V	5-128 W	0,91 A	PN10	-10 ÷ 110°C	230 VAC, 50/60 Hz	≤ 0.20

Wilo Para ST 25/6 iPWM

Manufacturer's references:
ST 25/6-43/IPWM2
4531416



iPWM 2 - Solar

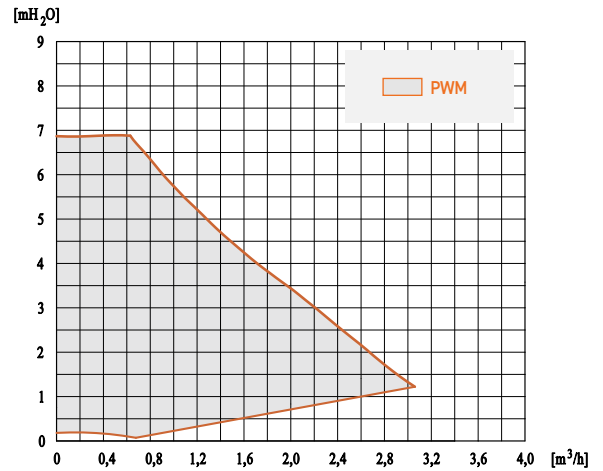

Length	Connection	Control modes	Power consumpt.	I max	PN	Temp. range	Electrical connection	EEI
180 mm	1"1/2	PWM	1-43 W	0,44 A	PN10	0 ÷ 100°C	230 VAC, 50/60 Hz	≤ 0.20

Grundfos UPM3 Hybrid 25-70

Manufacturer's references:
UPM3 Hybrid 25-70 180 ACA
99061648

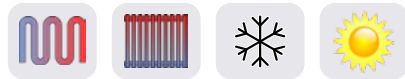

PWM A - Heating
PWM C - Solar

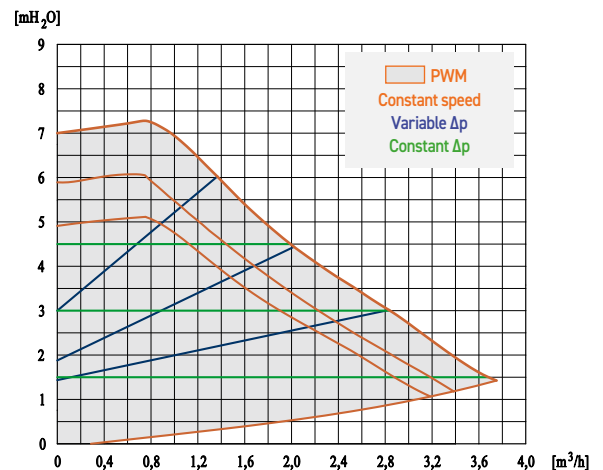

Length	Connection	Control modes	Power consumpt.	I max	PN	Temp. range	Electrical connection	EEI
180 mm	1"1/2	Δp-v / Δp-c / Const. speed / Auto / PWM	2-52 W	0,52 A	PN10	2 ÷ 110 °C	230 VAC, 50/60 Hz	≤ 0.20

Wilo Para ST 25/8 iPWM

Manufacturer's references:
ST 25/8-75/IPWM2
4531415



iPWM 2 - Solar

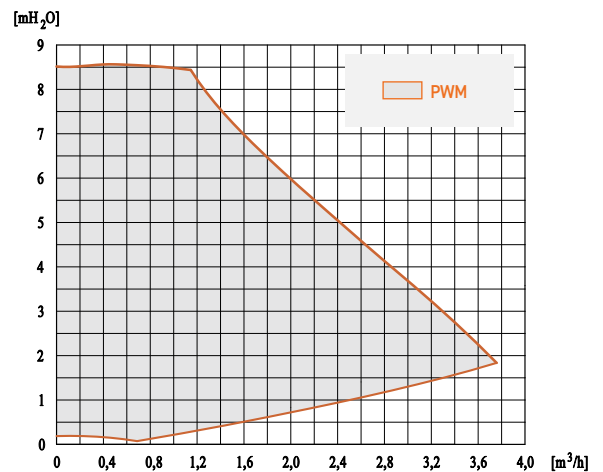

Length	Connection	Control modes	Power consumpt.	I max	PN	Temp. range	Electrical connection	EEI
180 mm	1"1/2	PWM	2-75 W	0,66 A	PN10	0 ÷ 100°C	230 VAC, 50/60 Hz	≤ 0.21

Wilo Para ST 15/13 iPWM

Manufacturer's references:
ST15/13-75IPWM2
4532496



iPWM 2 - Solar

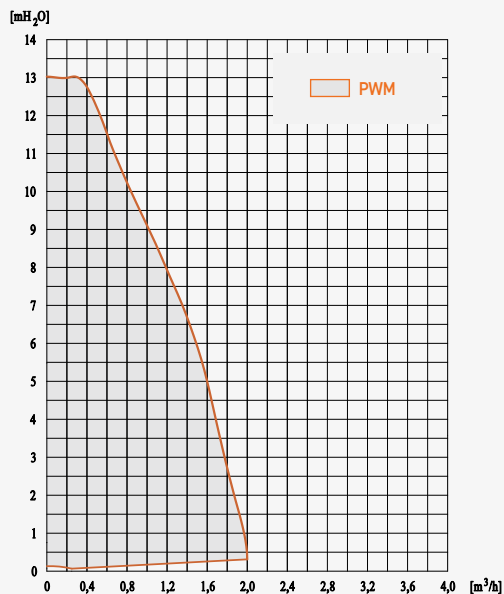

Lenght	Connection	Control modes	Power consumpt.	I max	PN	Temp. range	Electrical connection	EEl
130 mm	1"	PWM	2-75 W	0,66 A	PN10	0 ÷ 110 °C	230 VAC, 50/60 Hz	≤ 0.23

Wilo Para Maxo 25-180-08

Manufacturer's references:
Para MAXO 25-180-08-F02
U03-S BRV
2225098



PWM 1 - Heating
PWM 2 - Solar

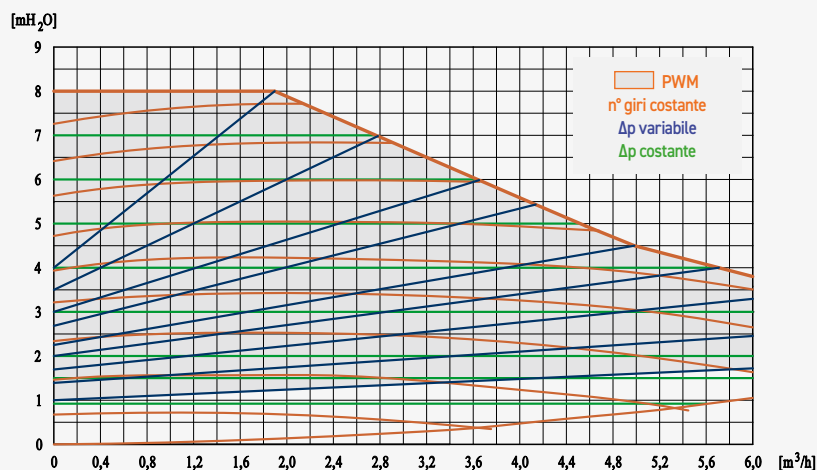

Lenght	Connection	Control modes	Power consumpt.	I max	PN	Temp. range	Electrical connection	EEl
180 mm	2"	Δp-v / Δp-c / const. speed / PWM / 0-10V	5-128 W	0,91 A	PN10	-10 ÷ 110°C	230 VAC, 50/60 Hz	≤ 0.20

Wilo Para 15/8 iPWM KU

Manufacturer's references:
Ku15/8-75/IPWM1
4531666



iPWM 1 - Heating
Pump housing in composite material

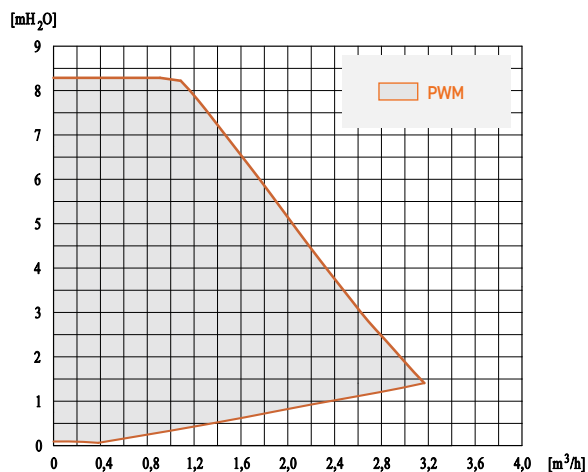

Lenght	Connection	Control modes	Power consumpt.	I max	PN	Temp. range	Electrical connection	EEI
130 mm	1"	PWM	2-75 W	0,66 A	PN6	0 ÷ 95°C	230 VAC, 50/60 Hz	≤ 0.21

Wilo Para 15/9 iPWM

Manufacturer's references:
15/9-87/IPWM1
4534456



iPWM 1 - Heating

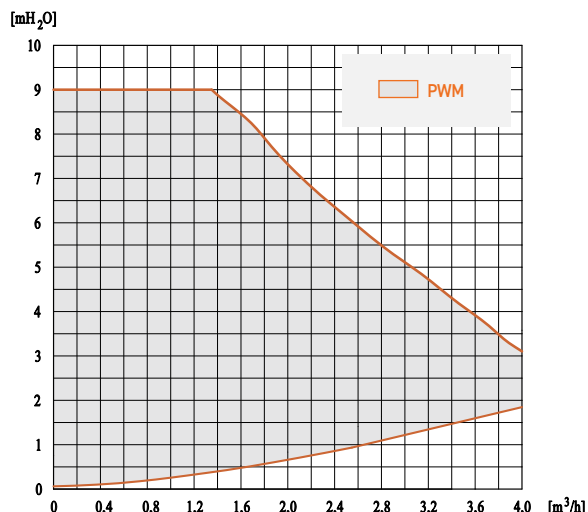

Lenght	Connection	Control modes	Power consumpt.	I max	PN	Temp. range	Electrical connection	EEI
130 mm	1"	PWM	3-87 W	0,80 A	PN10	0 ÷ 105°C	230 VAC, 50/60 Hz	≤ 0.21

Wilo Star Z 25/6

Manufacturer's references:
Star Z 25/6-3
4047573



Bronze pump housing

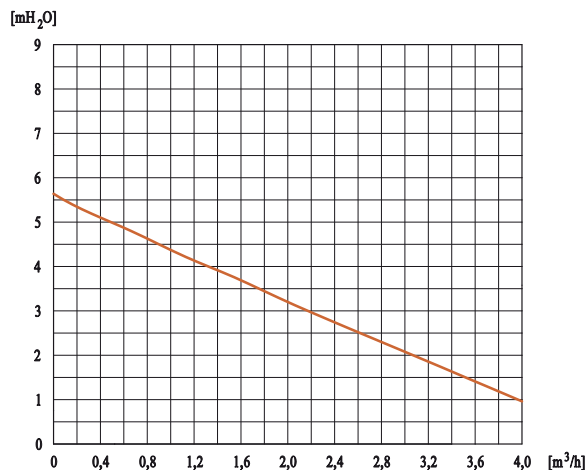

Lenght	Connection	Control modes	Power consumpt.	PN	Temp. range	Electrical connection
180 mm	1 1/2"	3 velocità	50-99 W	PN10	2 ÷ 65°C	230 VAC, 50/60 Hz

Lowara Ecocirc Pro 15-1/65B R

Manufacturer's references:
ecocirc Pro 15-1/65B R
60AOL3001

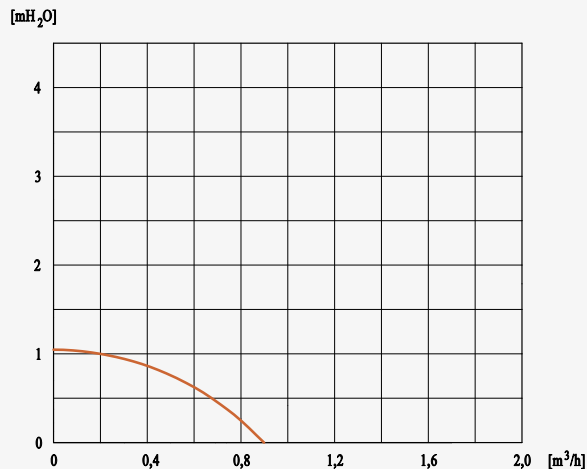

Length	Connection	Control modes	Power consumpt.	PN	Temp. range	Electrical connection
65 mm	1/2"	Variable speed	7,4-9 W	PN10	2 ÷ 95°C	100-240 VAC, 50/60 Hz

Lowara Ecocirc Pro 15-1/65B RU

Manufacturer's references:
ecocirc Pro 15-1/65B RU
60AOL6001



With timer

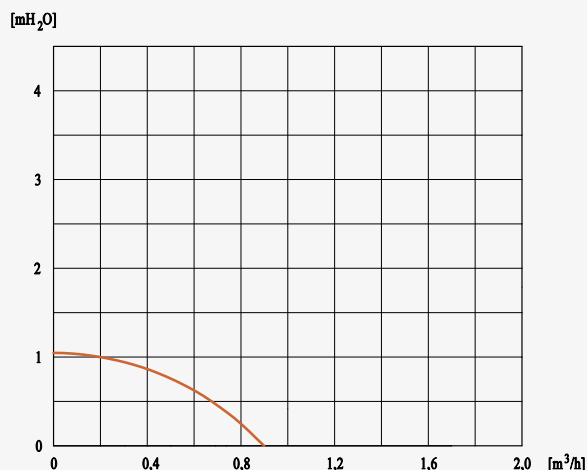

Length	Connection	Control modes	Power consumpt.	PN	Temp. range	Electrical connection
65 mm	1/2"	Variable speed	7,4-9 W	PN10	2 ÷ 95°C	230 VAC, 50 Hz

Lowara Ecocirc Pro 15-3/65B

Manufacturer's references:
ecocirc PRO 15-3/65B
60AOC1100YY004



Length	Connection	Control modes	Power consumpt.	PN	Temp. range	Electrical connection
65 mm	1/2"	Variable speed	3-27 W	PN10	2 ÷ 95°C	100-240 VAC, 50/60 Hz



50 years of great results.

A history of quality. Technical development, flexibility, customer satisfaction have become cornerstones of corporate policy and the foundations of BRV success on the international and national market.



Quality is our leading goal.



BRV is present directly or through its own commercial organization in Italy, in numerous European countries and in the rest of the world.

Industrial customers (O.E.M.) are supplied directly by BRV.

EUROPE

Austria
Belgium
Belarus
Bulgaria
Cyprus
Croatia
Denmark
Estonia

Finland
France
Germany
Great Britain
Greece
Ireland
Latvia
Lithuania

Luxembourg
Macedonia
Moldova
Norway
Holland
Poland
Portugal
Czech Republic
Romania

RUSSIA

Slovakia
Slovenia
Spain
Sweden
Switzerland
Ukraine
Hungary

ASIA

Saudi Arabia
Iran
Kuwait
Lebanon
Turkey
China
Kyrgystan

AFRICA

La Réunion
Madagascar
Marocco
Zambia

AMERICA

Bolivia
Canada
Chile
Messico
U.S.A.

OCEANIA

Australia
New Zeland



BRV will be happy to meet you during the next exhibitions





Warranty

BRV guarantees its ModvlvS pump units from manufacturing defects: 5 years for brassware, 2 years for other components (or what is granted by the manufacturer of the components). The warranty provides the replacing of the defected item: the way of handling the returns, due to assessed or presumed faultiness, must be in accordance with the procedure written in the special section "Customer Service" of the official website www.brv.it. Claims have to reach BRV within the maximum terms in compliance with the regulations in force. Charges, expenses, damages or indemnities are excluded.

The manufacturer's responsibility is limited to defects found out in conditions of normal use and correct use of the product. In case of any dispute rising from the use of BRV products, it will be regulated by the Italian Law in force and the sole Court of Vercelli will be competent.

The performances of the **ModvlvS** pump units are tested and guaranteed only if all the "accessory" devices are supplied by BRV (circulating pumps, actuators, controllers etc.). This because BRV cannot know and test all these "accessories" produced by the worldwide manufacturers. Anyway it is a mission of BRV to test all the most known devices within a reasonable period of time and eventually to update the **ModvlvS** systems accordingly.

Declaration of conformity

The ModvlvS products are properly manufactured, by completely fulfilling procedures stated in Company Certified Quality System to UNI EN ISO 9001:2015. In addition, all the used components correspond to EC directive regarding: materials, pressure devices, low-voltage components, electromagnetic compatibility, RoHS, etc.

Sales conditions

Minimum purchase order amount: Euro 250.00. A sum of Euro 30.00 will be charged on purchase orders of lower amount to cover their operating costs (spare parts and sample purchase orders are excluded). As regards other sales conditions please contact our sales department.

BRV reserves the right to amend the design and the specifications of the products, as well as to carry out improvements and technical developments, without prior note. All illustrations, numerical data, etc., are not binding.

All rights are reserved. You aren't allowed to publish the present publication under any form, even partial, excepting BRV's explicit consent. Moreover it's not allowed to disclose the catalogue in digital edition by web (pdf or other formats), excepting BRV's written consent. Any different action will be prosecuted according to law.



Bonetti Rubinetterie Valduggia S.r.l.

Loc. Molino Rastelli, 2
13018 Valduggia (VC) - Italy
Tel. +39 0163 48062
Fax +39 0163 48188

www.br.v.it

e-mail: info@br.v.it

ISO 9001:2015 Cert. No. 0853/8



Distributed by:

MODVLS

